

AGRO Kabelverschraubungen

AGRO Cable Glands

Für professionelle Kabeleinführungen.
For professional cable entries.

29



Progress® . Syntec® . EMV . Ex . Flanschwinkel . Zubehör
Progress® . Syntec® . EMC . Ex . Flanged elbows . Accessories

 **AGRO**
... your quality-connection



KAISER GROUP

 **AGRO**

 **ATTEMA**

 **HELIA**

 **KAISER**



Ulrich Kaiser

KAISER GmbH & Co. KG













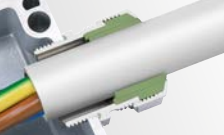

















Burkard Kaiser

Geschäftsführer / CEO
KAISER GmbH & Co. KG

Die KAISER GROUP, ein Familienunternehmen in der dritten Generation, setzt seit jeher auf Fortschritt und Tradition. Als Innovationsführer im Bereich von Elektroinstallationsprodukten und Kabeleinführungen wollen wir für unsere Kunden mit starken Ideen und Lösungen der Branche stets einen Schritt voraus sein. Qualifizierte, erfahrene Mitarbeiterinnen und Mitarbeiter sind dabei der Garant für die hohe Qualität der KAISER GROUP. Unsere Partner im Fachhandwerk und -handel sowie in der Industrie können auf unsere Innovationskraft für die Märkte von heute und morgen vertrauen. Dies gilt auch für den kundennahen Service und die schnelle Lieferfähigkeit, die eine starke Elektromarke auszeichnen.

The KAISER GROUP, a family-run company in its third generation, has always placed emphasis on progress and tradition. As a leading innovator in the area of electrical installation products and cable entries, our goal is to always be a step ahead in our industry, supporting our customers with our practical ideas and solutions. In this regard, our qualified, experienced employees ensure the high quality you can expect from KAISER. Our trades, retail and industry partners can trust our innovative strength to meet the market's needs – today and in the future. The same is also true for our customer-oriented service and fast delivery times, aspects which mark a truly strong brand of electrical products.



	Kabelverschraubungen Progress® Messing vernickelt Cable glands Progress® nickel-plated brass		1
		12 - 56	
	Kabelverschraubungen Progress® rostfreier Stahl A2 / A4 Cable glands Progress® stainless steel A2 / A4		2
		57 - 66	
	Spezielle Kabelverschraubungen und Kabeleinführungen Messing vernickelt Special cable glands and cable entries nickel-plated brass		3
		67 - 85	
	EMV Kabelverschraubungen Progress® Messing vernickelt EMC cable glands Progress® nickel-plated brass		4
		86 - 108	
	EVolution EMC Komponenten EVolution EMC components		5
		109 - 118	
	Mehrfachdurchführung MCE Multi-cable entry MCE		6
		119 - 121	
	Kabelverschraubungen Progress® Messing nach EN 45545 Cable glands Progress® nickel-plated brass according to EN 45545		7
		122 - 139	
	Ex Kabelverschraubungen Messing oder Kunststoff Ex cable glands nickel-plated brass or synthetic		8
		140 - 185	
	Kabelverschraubungen Progress® AgreenO Messing bleifrei Progress® AgreenO cable glands of lead-free brass		9
		186 - 195	
	Kombi-Schlauchverschraubungen Messing vernickelt mit integrierter Kabelverschraubung Combination conduit glands nickel-plated brass with integrated cable gland		10
		196 - 209	
	Kabelverschraubungen Progress® Kunststoff Synthetic cable glands Progress®		11
		210 - 221	
	Kabelverschraubungen Syntec® Messing vernickelt und Kunststoff Cable glands Syntec®, nickel-plated brass or synthetics		12
		222 - 232	
	Spezielle Kabelverschraubungen und Kabeleinführungen Kunststoff Special cable glands and cable entries synthetic		13
		233 - 238	
	Zubehör zu Kabelverschraubungen Kunststoff oder Metall AGROflex Geflechschläuche Accessories for cable glands synthetic or metal AGROflex braided sleeveings		14
		239 - 291	
	Zusatzinformationen / Sonderlösungen Additional information / Special solutions		15
		292 - 347	



AGRO
Hunzenschwil, Schweiz

AGRO
Hunzenschwil, Switzerland

Seit 1953, entwickelt und fertigt AGRO vom Standort Hunzenschwil (Schweiz) aus qualitativ hochwertige Produkte und Systeme zur Einführung und Verlegung von Kabeln für die Maschinenindustrie, für den Anlagen- und Apparatebau sowie für die professionelle Elektroinstallation in Gebäuden aller Art. AGRO gehört seit 2002 zur KAISER-Unternehmensfamilie. Die Synergien aus unserer Unternehmensfamilie, kommen Ihnen national und international zu Gute.

Since 1953 – AGRO has been developing and manufacturing high-quality cable entry and cable installation products and systems, at its Hunzenschwil headquarters in Switzerland, for the mechanical engineering industry, for plant and equipment construction and for professional electrical installation work in buildings of all kinds. AGRO has been part of the KAISER GROUP since 2002, enabling our customers to benefit from the resulting synergies – both nationally and internationally.

Gemeinsam Zukunft gestalten Creating the future **together.**

Die Marken KAISER, AGRO, HELIA und ATTEMA bieten Ihnen immer die marktgerechte Installationslösung und unterstützen Sie so effektiv bei Ihren täglichen Aufgaben. Durch die kontinuierlichen, zukunftsorientierten Produktinnovationen sind Sie mit den vier starken Marken stets auf dem neuesten Stand der Technik – heute und morgen.

The KAISER, AGRO, HELIA and ATTEMA brands consistently offer you installation solutions which meet the needs of the market and thereby effectively support you in your daily work. Through their continuous future-oriented product innovations, these four strong brands keep you at the forefront of technology – today and tomorrow.

KAISER Hauptsitz / Head office
Schalksmühle, Deutschland
Schalksmühle, Germany



ATTEMA
Gorinchem, Niederlande
Gorinchem, Netherlands



HELIA
Erembodegem, Belgien
Erembodegem, Belgium



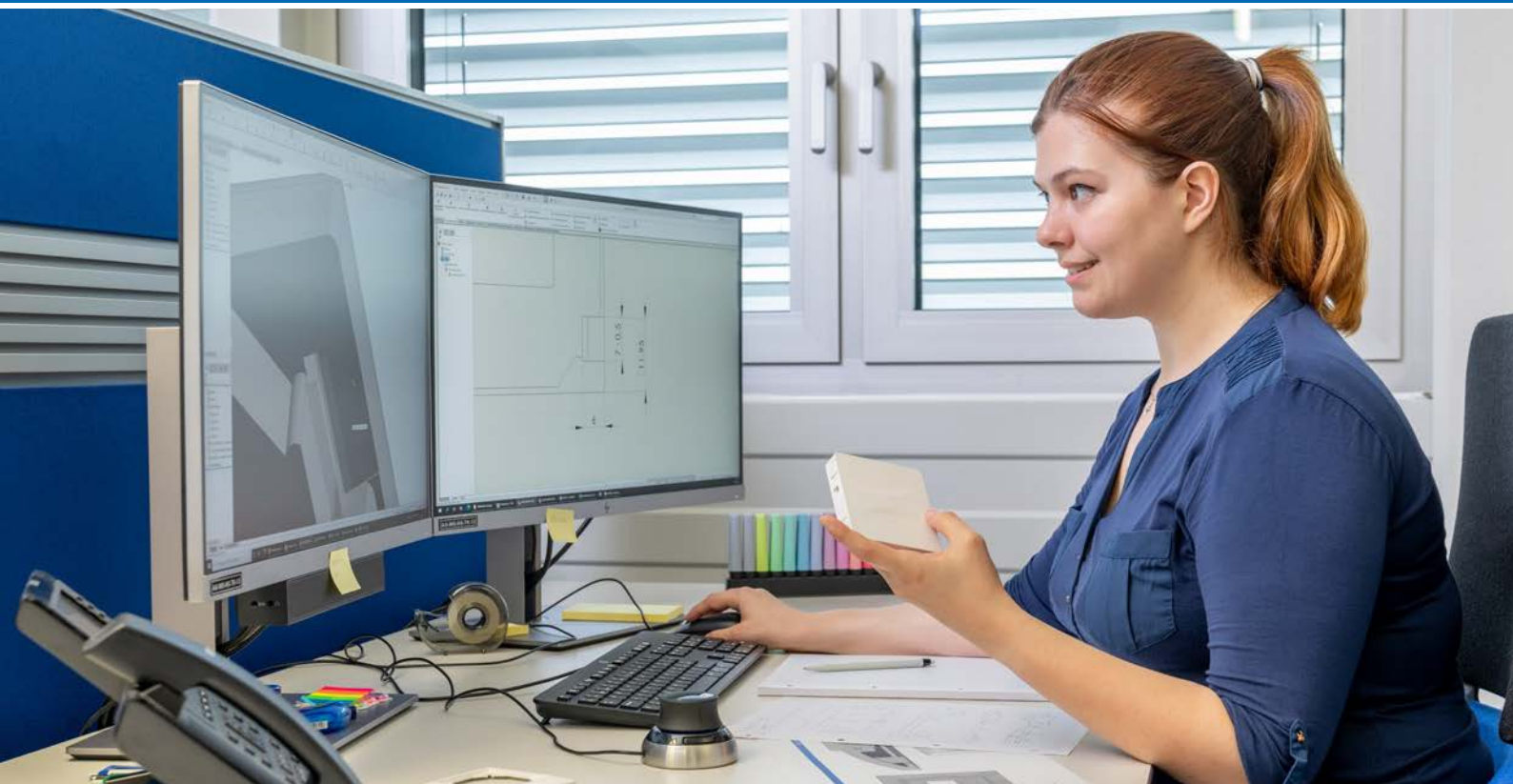

agro.ch



agro.ch

Immer auf dem neuesten Stand und alle weiterführenden Informationen zu Produkten, Systemlösungen und Kommunikationsmedien finden Sie unter **www.agro.ch**.

Mit unserer einzigartigen Produkt-Suchmaschine finden Sie die passende Kabelverschraubung durch Eingabe des Kabel-Durchmessers.

Always up to date – all further information relating to our products and system solutions can be found at **www.agro.ch**.

Our unique product finder tool can help you to select the right cable gland solution simply by entering the cable diameter etc.



CAD-Daten in allen gängigen Formaten

Von nahezu allen Kabelverschraubungen kann die 3D-Produktansicht eingeblendet werden. Hier bieten wir Ihnen den besonderen Service, die jeweiligen Daten in allen gängigen CAD-Formaten sich per E-Mail zusenden zu lassen.

Die 3D-Ansicht und die Bestellmöglichkeit für die CAD-Daten können Sie über den Navigationspunkt „BIM- / CAD-Daten“ in der Produkt-Einzelansicht im Navigationsmenü unter den Produktdaten aufrufen.

CAD-data in all current formats.

For almost all cable glands, a 3D view can be displayed. 3D CAD data may be requested and will be sent via email in all current formats.

You have the possibility to display a 3D view or to order CAD data when you choose a specific item and click on "BIM / CAD data" in the navigation bar below the product details.



Eplan



Buildup



BIM

EN 45545-2

HL 3



Kabelverschraubungen Progress® in Metall.

Zertifiziert für Schienenfahrzeuge
nach EN 45545 und NFPA 130.

AGRO Progress® Kabelverschraubungen aus Metall können mit Dichteinsätzen aus einem speziellen TPE bestückt werden. In dieser Ausführung sind sie zertifiziert nach EN 45545 sowie NFPA 130 und können bedenkenlos für alle Anwendungen und Anordnungen im Schienenfahrzeugbau eingesetzt werden.

Beste Resultate nach EN 45545-2

Die Dichteinsätze der Progress® Kabelverschraubungen sind im anspruchsvollsten **Hazard Level 3** zertifiziert. Die geforderten Werte für Hazard Level 3 wurden sowohl im Aussen- als auch im Innenbereich deutlich übertroffen. Auch die Werte für die NFPA (ASTME) waren ausgezeichnet.



Cable glands Progress® made of metal.

Certified for rolling stock, according
to EN 45545 and NFPA 130.

AGRO Progress® metal cable glands can be equipped with sealing inserts made of a special TPE. These versions are certified according to EN 45545 as well as NFPA 130 and can be used with confidence for any rolling stock application.

Best results in testing according to EN 45545-2

The sealing inserts of Progress® cable glands are certified to the most demanding **Hazard Level 3**. The stipulated values for Hazard Level 3 were easily achieved, for both internal and external areas. The results achieved in NFPA (ASTME) testing were also excellent.



Progress® multiLAYER.

Universelle Kabelverschraubung
mit maximalem Klemmbereich.

Mit der neuen **Progress® multiLAYER** muss pro Anschlussgewinde nur noch eine Kabelverschraubung bewirtschaftet werden. Der neue **multiLAYER Dichteinsatz** bietet einen enorm grossen Klemmbereich und verfügt über einen integrierten Staubschutz für die Kabelverschraubung. Die geschlitzte Ausführung erlaubt eine schnelle Montage bei vorkonfektionierten Kabeln. Die Kabelverschraubung nutzt die Progress® Kompressionstechnik und klemmt das Kabel schonend und ohne Einschnürung. Der neue Dichteinsatz kann problemlos mit anderen Komponenten des herausragenden Progress® Baukastens kombiniert werden.

Progress® multiLAYER.

Maximum installation flexibility
thanks to maximum clamping range.

With the new **Progress® multiLAYER** cable gland, only one type of cable gland is needed per entry thread. The new **multiLAYER sealing insert** offers an extremely wide clamping range and features integrated dust protection for the cable gland. The splittable version allows quick installation on preassembled cables. The cable gland uses Progress® compression technology and clamps cables gently and without causing necking. Furthermore, this innovative sealing insert can be easily combined with other components of the outstanding modular Progress® product range.



Progress® EMV powerCONNECT.

Direkte Anschluss-technik für hohe
Ableitströme auf kleinstem Raum.

Die Progress® EMV powerCONNECT mit der neuartigen fortschrittlichen Presshülse garantiert eine sichere 360° Schirmkontaktierung auf kleinstem Raum. Der direkte Übergang vom Geflecht auf das Unterteil der Kabelverschraubung gewährleistet einen erstaunlich niedrigen Übergangswiderstand.

Progress® EMC powerCONNECT.

Direct connection technology for high
leakage currents in a very compact unit.

Progress® EMC powerCONNECT, with its innovative, advanced compression sleeve, ensures reliable 360° shield contact in a very compact unit. The direct transfer from the shielding to the cable gland's lower part ensures extremely low transfer resistance.

Progress® EMV easyCONNECT.

Mit Klemmbacken für erhöhte Sicherheit Ex e II.

Gewährleistet volle Installationskontrolle und gleicht Toleranzen in den Schirmdicken für einen sicheren Schirmabgriff aus. Das Federsystem ermöglicht eine gute und sichere Schirmkontaktierung sowohl bei partiell abisolierten Abschirmkabeln als auch bei vollständig freigelegten Kabelschirmen.

Progress® EMC easyCONNECT.

With clamps for „increased safety“ (Ex e II)

Guarantee full control during installation and compensates for tolerances in shielding thicknesses to make a secure screened tap connection. The spring system provides for good, reliable shield contact in the case of partially stripped shielded cables and of fully exposed cable shields.



AGRO Multi Cable Entry MCE.

Für eine dichte und prozesssichere Durchführung.

AGRO MCE kommt überall dort zum Einsatz, wo eine grössere Anzahl Kabel in einer geforderten Packungsdichte hindurch zu führen ist. Gegenüber vielen einzelnen Kabelverschraubungen sparen die kompakten MCE Platz und Verwender profitieren von einer rationellen und gut zugänglichen Montagesituation – selbst unter beengten Platzverhältnissen.

AGRO Multi Cable Entry MCE.

For well-sealed, process-reliable cable entries.

AGRO MCE finds application wherever a number of cable entries must be located close together. Compared to the use of many individual cable glands, the compact MCE solution saves space and enables users to benefit from an efficient installation layout with easy accessibility – even where space is very limited.



EVolution EMC.

Die erste EMV-Kabelverschraubung mit gecrimpter und steckbarer EMV-Schirmkontaktlösung.

Verblüffend einfach und robust: Die steckbare EMV-Kontaktlösung macht die EVolution EMC enorm leistungsfähig. Durch die einzigartige Konstruktionsweise der Schirmkontaktlösung ist sie die erste EMV-Kabelverschraubung mit Servicefunktion.

EVolution EMC.

The first EMC cable gland with a crimped and “pluggable” EMC shield contact solution.

Amazingly simple and robust: The “pluggable” (easily disconnectable) EMC shield contact solution makes the EVolution EMC extremely powerful. Due to the unique design of this shield contact solution, it is the first EMC cable gland that is designed to facilitate maintenance and repair.



AGRO kundenspezifische Lösungen.

Wir machen sie möglich.

Als kompetenter Partner bieten wir nicht nur ein breites Standard-Sortiment, sondern entwickeln auch kundenspezifische Lösungen, passend für individuelle Anwendungsfälle.

Schon in der Entwicklungsphase beraten wir Sie bei der Umsetzung Ihrer Projekte. Dadurch ist es möglich, die hohen Anforderungen Ihrer Produkte an Funktionalität und Design unter wirtschaftlichen Gesichtspunkten gemeinsam zu gestalten.

- Viele Lösungen aus unserem Progress® Baukasten sind schnell und einfach realisierbar
- Individuelle Systemlösungen für spezielle Anforderungen
- Umfangreiche Beratung und Bemusterung bereits in der Entwicklungsphase

AGRO customised solutions.

We make it possible.

As your competent partner, we not only offer a wide range of standard products, but also develop customized solutions to accommodate your specific needs.

Already in the development phase, we will be pleased to provide advice on the implementation of your projects. This will enable us to jointly define the specific requirements of your products in terms of functionality and design while considering economic efficiency.

- Many solutions can be implemented quickly and easily using the modular components of our Progress® system
- Individual system solutions for special requirements
- Comprehensive advice and provision of samples as early as the development phase





Im Verkehrswesen kommt es vor allem auf den sicheren Halt der Zuleitung an. Die in der Bahntechnik verwendeten Progress®-Kabelverschraubungen lockern sich trotz hoher Rüttelbelastungen nicht. Daher ermöglichen sie eine einwandfreie Strom- und Signalübertragung im gesamten Schienenfahrzeug. Es sind zertifizierte Dichteinsätze für Schienenfahrzeuge nach EN 45545 und NFPA 130 verfügbar.

In the field of transportation, secure gripping of electrical cables is vital. The Progress® cable glands used in railway technology do not become loose, despite strong vibrations. This enables power and signals to be reliably transmitted throughout the train. Certified sealing inserts are available for railway applications, according to EN 45545 and NFPA 130.



Messing oder Kunststoff Syntec® Kabelverschraubungen sind die ideale Lösung für vielfältige **tägliche Aufgaben**. Die einzigartige patentierte Lamellentechnik klemmt das Kabel auf schonende Art und Weise und garantiert eine sichere Kabeleinführung mit hervorragender Zugentlastung.

Nickel-plated brass or synthetic Syntec® cable glands represent the optimal solution for a wide range of **daily tasks**. The patented, unique lamellar technology clamps the cable in a protective way and ensures a reliable cable entry with outstanding strain relief.



Durch Staub und Abgase entsteht ein beträchtliches Mass an chemischer Belastung in **Tunneln**. Diese erfordert den Einsatz von rostfreien und säurebeständigen Kabelverschraubungen aus Stahl A4 mit FPM Dichteinsatz. Kabeldurchmesser von 2.0 mm bis 52.0 mm können sicher eingeführt werden.

Dust and exhaust emissions cause high levels of chemical pollution in **tunnels**. This calls for the use of stainless and acid-resistant A4 steel cable glands with FPM sealing insert. These can be used to reliably accommodate cables of diameter 2.0 mm to 52.0 mm.



Kabelverschraubungen für den Einsatz im **Schiffsbau** müssen spezifische Anforderungen erfüllen. Ein DNV-Zertifikat bescheinigt die Erfüllung dieser Anforderungen. Alle metrischen AGRO Kabelverschraubungen sind DNV zertifiziert. Unabhängig von ihrem Gewinde sind zusätzlich alle AGRO Ex-Kabelverschraubungen für den Einsatz im Schiffsbau zugelassen.

For the **shipbuilding industry**, cable glands have to meet specific requirements. DNV certification confirms the fulfillment of such requirements. All metric AGRO cable glands are DNV-certified. All AGRO Ex cable glands are also approved for shipbuilding applications, irrespective of their entry thread.

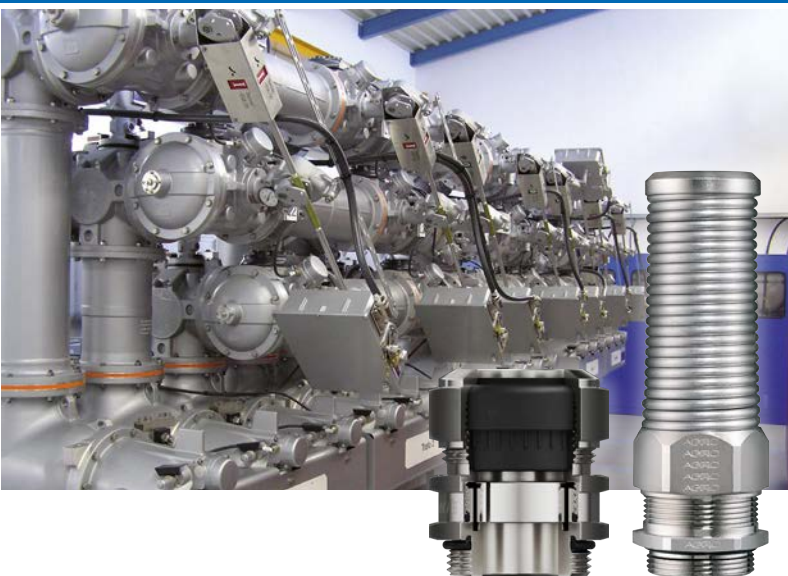

Elektronisch gesteuerte **Umspannstationen** funktionieren so lange reibungslos, wie keine Signale durch Störströme verfälscht werden. Der konzentrische Schirmabgriff der Progress® EMV Kabelverschraubungen führt Störströme auf Masse und garantiert kleinste Transferimpedanzen.

Electronically-controlled **substations** operate smoothly as long as the signals are not distorted by interference currents. The concentric shield grip of Progress® EMC cable glands discharges interference currents to earth and thus minimises transfer impedance.



In der **Lebensmittelindustrie** kommen keimtötende Substanzen zum Einsatz. Diese Substanzen garantieren auf der einen Seite die Hygiene und stellen auf der anderen Seite besondere Anforderungen an die eingesetzten Materialien der Produktionsmittel. Progress® aqua haben die KTW W270 Zulassung und können bedenkenlos in Trinkwasseranlagen eingesetzt werden.

In the **food industries**, anti-bacterial substances are used to ensure a high level of safety. These substances, however, also present a particular challenge for the materials used in the production facilities. Progress® aqua cable glands are KTW W270-certified for drinking water applications.



Raffinerien und Produktionsanlagen der chemischen Industrie mit explosionsgefährdeten Bereichen stellen besondere Anforderungen an die elektrische Installation. AGRO bietet zertifizierte Kabelverschraubungen für druckfeste Kapselung Ex d IIC, für erhöhte Sicherheit Ex e II und für Eigensicherheit Ex i II an.

Refineries and production facilities in the chemical industry with potentially explosive areas make specific demands on electrical installations. AGRO offers certified cable glands for "flameproof enclosures" (Ex d IIC), for "increased safety" (Ex e II) and for "intrinsic safety" (Ex i II).



Bei der Realisierung von **Windkraftanlagen** bietet die Progress®-Baureihe eine kabelschonende Zugentlastung mit hoher Verdrehsicherheit. Dabei spielt es keine Rolle, ob es sich um Rundkabel oder Flachleitungen handelt.

For the construction of **wind power stations**, the Progress® range offers cable-protecting strain relief with good protection against cable rotation – regardless of whether the cables are round or flat.



Professionelle Lösungen für die sichere Kabeleinführung

Progress® Kabelverschraubungen bieten ein umfangreiches Sortiment aus Kunststoff, Messing oder rostfreiem Stahl A2 / A4 und sind bewährte Helfer für die fachgerechte Kabeleinführung in Industrieanlagen. Die herausragende Kompressionstechnik sorgt für eine hohe Dichtigkeit und eine äusserst kabelschonende Zugentlastung.

Kabelverschraubungen Progress® aus Metall können mit Dichteinsätzen aus einem speziellem TPE bestückt werden. In dieser Ausführung sind sie zertifiziert nach EN 45545 sowie NFPA 130.

Progress® EMV-Kabelverschraubungen aus Messing oder Edelstahl sorgen für eine niederimpedante Verbindung zwischen Schirmgeflecht und Metallgehäuse bei einer gleichzeitig sicheren Kabeleinführung.

Progress® Ex-Kabelverschraubungen aus Kunststoff oder Messing sorgen auch in explosionsgefährdeten Bereichen für eine sichere Kabeleinführung.

Syntec® Kabelverschraubungen aus Kunststoff oder Messing sind die optimale Lösung für Ihre täglichen Installations-Aufgaben. Die überragend, einzigartige Lamellentechnik garantiert immer eine praxisgerechte Kabeleinführung, bei hervorragender Zugentlastung.

Professional solutions for a safe cable entry

Progress® cable glands made of synthetics, nickel-plated brass or stainless steel A2 / A4 are proven aids for professional cable entry in industrial plants. The excellent compression technology ensures tight seals and strain relief which is exceptionally easy on cables.

Progress® cable glands made of metal are certified for railway applications according to EN 45545 and NFPA 130.

Progress® EMC cable glands made of nickel-plated brass ensure a low-impedance connection between the braided shield and the metal housing while maintaining secure cable entry.

Progress® Ex cable glands made of synthetics or nickel-plated brass ensure secure cable entry even in potentially explosive environments.

Syntec® cable glands made of synthetics or nickel-plated brass are the optimal solution for your daily installation tasks. The outstanding, unique lamellar technology always guarantees cable entry with excellent strain relief.

	Progress® Messing Progress® nickel-plated brass	Progress® rostfreier Stahl A2 / A4 Progress® stainless steel A2 / A4	Spezielle Kabelverschraubungen Special cable glands	EMV Progress® Messing EMC Progress® nickel-plated brass	Ex Messing oder Kunststoff Ex nickel-plated brass or synthetic	Kombi-Schlauchverschraubungen Combination conduit glands nickel-plated brass	Progress® Kunststoff Progress® synthetic	Syntec® Messing und Kunststoff Syntec® synthetic and nickel-plated brass	Spezielle Kabelverschraubungen Special cable glands	Kunststoff synthetic
Kapitel Chapter	1/7/9	2	3	4	8	10	11	12	13	
Ausführung / Design										
Kompressionstechnik Compression technology	•	•	•	•	•	•	•	-	•	
Lamellentechnik Lamellar technology	-	-	-	-	-	-	-	•	-	
Gewinde / Thread										
Anschlussgewinde metrisch Entry thread metric	•	•	•	•	•	•	•	•	•	
Anschlussgewinde Pg Entry thread Pg	•	•	•	•	•	•	•	•	•	
Anschlussgewinde NPT Entry thread NPT	•	-	-	-	•	-	-	•	-	
Anschlussgewinde Gasrohr Entry thread gas-pipe	•	-	-	-	•	-	-	-	-	
Kurzes Anschlussgewinde Short entry thread	•	-	•	•	•	•	-	•	•	
Langes Anschlussgewinde Long entry thread	•	•	•	•	•	•	•	•	-	
Dichteinsatz / Sealing insert										
Für Rundkabel For round cables	•	•	•	•	•	•	•	•	•	
Für Flachkabel For flat cables	•	-	-	-	-	-	A	-	-	
Für mehrere Kabel For mutiple cables	•	A	-	-	•	A	•	-	-	
TPE/NBR-Dichteinsatz (bis 100°C) TPE/NBR sealing insert (up to 100°C)	•	•	•	•	•	•	•	•	•	
FPM-Dichteinsatz (bis 200°C) FPM sealing insert (up to 200°C)	•	•	-	•	-	-	-	-	-	
EPDM Dichteinsatz KTW W270 EPDM sealing insert KTW W270	-	•	-	-	-	-	-	-	-	
Spezial TPE für EN 45545 Special TPE for EN 45545	•	•	•	•	-	•	-	-	A	
Technische Besonderheiten / Technical features										
Knickschutz Anti-kink protection	•	-	-	•	-	-	-	•	-	
Biegeschutz Bending protection	•	-	•	-	•	-	-	-	-	
Externe Zugentlastung External strain relief	•	-	•	•	•	-	-	-	-	
Für Schlauchanschluss For conduit connection	•	-	-	-	-	•	-	-	-	
Material / Material										
Polyamid Polyamide	-	-	-	-	-	-	-	•	•	
Polyamid glasfaserverstärkt Polyamide – glass fibre reinforced	-	-	-	-	-	-	•	-	-	
Messing vernickelt Nickel-plated brass	•	-	•	•	•	•	-	•	-	
Messing vernickelt bleifrei Lead-free nickel-plated brass	•	-	•	•	-	A	-	A	-	
Rostfreier Stahl A2/A4 Stainless steel A2/A4	-	•	-	-	•	-	-	-	-	

A = auf Anfrage / upon request

AGRO Kabelverschraubungen Progress® Messing

AGRO Progress® cable glands nickel-plated brass

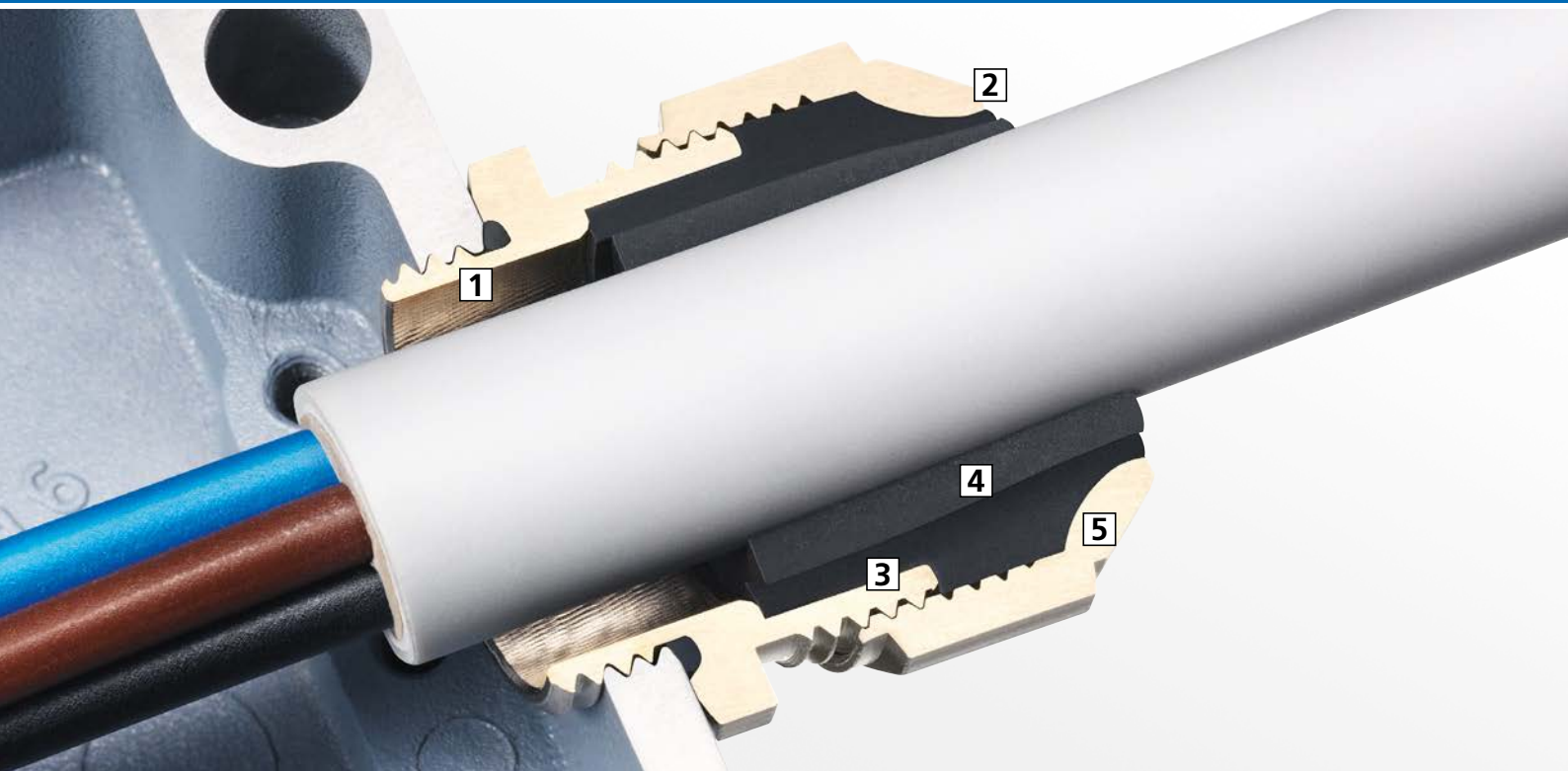

AGRO Kabelverschraubungen Progress® Messing vernickelt sind bewährte Helfer für die fachgerechte Kabeleinführung in Industrieanlagen. Durch die richtige Wahl mit dem passenden Dichteinsatz sind sie überall einsetzbar. Die herausragende Kompressionstechnik sorgt für eine hohe Dichtigkeit und eine äusserst kabelschonende Zugentlastung auch bei dynamischen Belastungen.

AGRO Progress® Kabelverschraubungen aus Metall mit Dichteinsätzen aus einem speziellen TPE sind zertifiziert nach EN 45545 sowie NFPA 130 und können bedenkenlos für alle Anwendungen und Anordnungen im Schienenfahrzeugbau eingesetzt werden.

1 Kurze, lange oder Spezial-Anschlussgewinde

Kabelverschraubungen Progress® mit kurzem oder langem Anschlussgewinde in metrischer, Pg-, Gasrohr oder NPT-Ausführung können bei vorhandenem Öffnungsgewinde oder mit Gegenmutter verwendet werden.

2 Sichtbare Sicherheit

Der kleine Wulst des Dichteinsatzes bestätigt das richtige Anzugsdrehmoment.

3 Hoher Verdrehschutz

Die im Unterteil integrierte Längsrandrierung sorgt über den Dichteinsatz für eine hohe Verdrehsicherheit.

4 Grosse Flexibilität

Zweiteilige Dichteinsätze können in Sekundenschnelle vor Ort auf den vorhandenen Kabeldurchmesser angepasst werden.

5 Garantierte Dichtigkeit

Auf den Dichteinsatz abgestimmte Innenkonturen sorgen für eine zielgerichtete Verformung des Dichteinsatzes und garantieren somit dessen perfekte Abdichtung. Die Schutzart IP 68 bis 10 bar sowie IP 69 ermöglichen eine breite Anwendung.

Cable glands Progress® nickel-plated brass are tried and tested aids for high-quality cable entries in industrial equipment. Correctly selected and with the right sealing insert, they can be used anywhere. The outstanding compression technology ensures an effective seal and excellent cable-protecting strain relief, also in the case of dynamic loading.

AGRO Progress® metal cable glands equipped with sealing inserts made of special TPE are certified according to EN 45545 and NFPA 130, and can be used with confidence for any rolling stock application.

1 Short, long or special entry thread

Progress® cable glands with short or long entry thread with metric, Pg, imperial or NPT designs can be used with existing hole threads or with a counter nut.

2 Visible reliability

A slight bulging of the sealing insert confirms the correct tightening torque.

3 Good anti-rotation protection

The longitudinal knurling (surface texture) applied to the cable gland's lower part provides a high degree of protection against rotation via the sealing insert.

4 Great flexibility

It only takes a few seconds to adapt the two-part sealing insert on site to the existing cable diameter.

5 Reliable leak-tightness

Inner contours matched to the sealing insert ensure a targeted deformation of the insert and thus ensure its leak-tightness in compliance with protection class IP 68 up to 10 bar and IP 69K for a wide range of applications.

Progress®: Der Baukasten Progress®: Modular assembly system

Der modulare Aufbau unserer Kernserie **Progress®** ist eine ihrer ganz grossen Stärken. Die Bauteile sind aufeinander abgestimmt und können frei kombiniert werden.
The modular design of our Progress® range is one of its great strengths. The components are designed with the others in mind, and can be freely combined with each other..

Standard Oberteile Standard upper parts

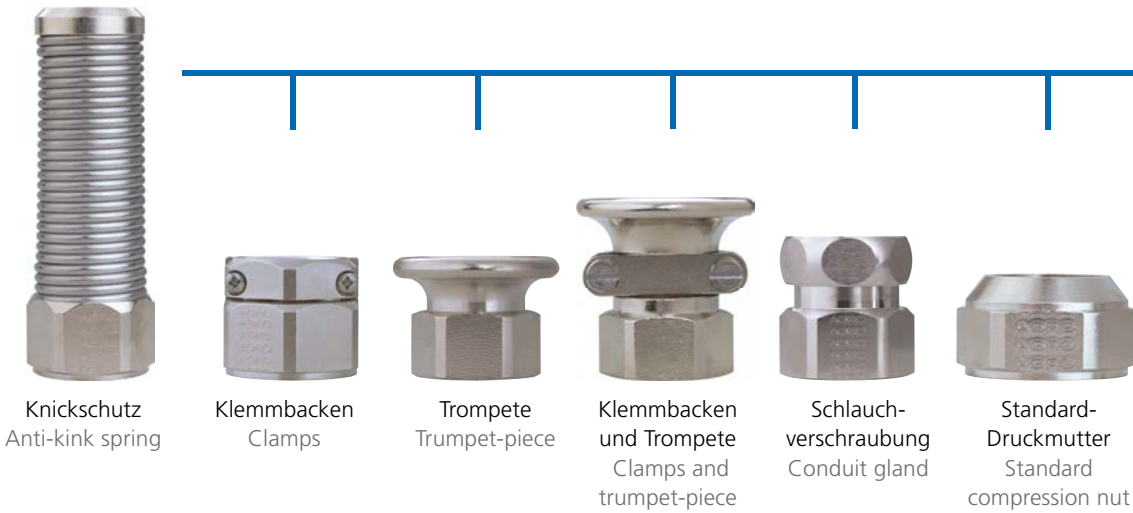

Standard Dichteinsätze Standard sealing inserts



Kurzer ein- oder zweiteiliger Dichteinsatz in NBR, TPE, Spezial TPE nach EN 45545 oder FPM (temperaturbeständig)
Short one- or two-piece sealing insert made of NBR, TPE, special TPE according to EN 45545 or FPM (heat resistant)

Langer durchgehend isolierender Dichteinsatz in NBR, TPE, Spezial TPE nach EN 45545 ein oder zweiteilig
Long one- or two-piece full-length insulating sealing insert made of NBR, TPE or special TPE according to 45545

Für die gängigsten Kabeldurchmesser sind Dichteinsätze für die Durchführung mehrerer Kabel verfügbar
For the most common cable diameters, sealing inserts are available for the entry of several cables at once

Standard Unterteile Standard lower parts



	Progress® Messing Progress® nickel-plated brass	Standard	Für hohe Temperaturen For high temperatures	Für mehrere Kabel For multiple cables	Mit Dichteinsatz Sealing insert with no hole	Für spezielle Kabel For special cables	Mit Knickschutzfeder With special entry thread	Mit Klemmbacken With anti-kink spring	Mit Trompete With trumpet-piece	Mit Trompete und Klemmbacken With trumpet-piece and clamps	
Ausführung / Design											
Kompressionstechnik Compression technology		•	•	•	•	•	•	•	•	•	
Gewinde / Thread											
Anschlussgewinde metrisch Entry thread metric		•	•	•	•	•	•	•	•	•	
Anschlussgewinde Pg Entry thread Pg		•	•	•	•	•	•	•	•	•	
Anschlussgewinde NPT Entry thread NPT		•	-	-	-	-	-	-	-	-	
Anschlussgewinde Gasrohr Entry thread Gas pipe		•	-	-	-	-	-	-	-	-	
Kurzes Anschlussgewinde (Standard) Short entry thread (standard)		•	•	•	•	•	•	•	•	•	
Langes Anschlussgewinde Long entry thread		•	•	•	•	•	-	•	•	•	
Sondergewinde (extra lang, Innengewinde) Special thread (extra long, internal thread)		•	-	-	-	-	•	-	-	-	
Dichteinsatz / Sealing insert											
Für Rundkabel For round cable		•	•	•	-	-	•	•	•	•	
Für Flachkabel For flat cable		•	-	-	-	•	-	-	-	-	
Für mehrere Kabel (Multi-Dichteinsatz) For multiple cables (Multi-sealing insert)		•	-	•	-	-	-	-	-	-	
Vollgummi-Dichteinsatz Full rubber sealing insert		•	•	-	•	-	-	-	-	-	
Einteiliger Dichteinsatz One-piece sealing insert		•	•	•	•	•	-	•	•	-	
Zweiteiliger Dichteinsatz Two-piece sealing insert		•	•	-	-	-	•	•	•	•	
multiLAYER Dichteinsatz multiLAYER sealing insert		•	-	-	-	-	A	A	A	A	
Spezial TPE nach EN45545 Special TPE acc. to EN 45545		•	-	•	•	•	•	•	•	•	
Technische Besonderheiten / Technical features											
Vibrationsschutz Vibration resistance		•	•	•	•	•	•	•	•	•	
Material / Material											
Messing vernickelt Nickel-plated brass		•	•	•	•	•	•	•	•	•	

A = Auf Anfrage / A = upon request



<p>Kabelverschraubungen Progress® Messing Cable glands Progress® nickel-plated brass</p>		<p>16 - 29</p>	<p>1</p>
<p>Kabelverschraubungen Progress® Messing für mehrere Kabel Cable glands Progress® nickel-plated brass for installation of multiple cables</p>		<p>30 - 33</p>	<p>2</p>
<p>Kabelverschraubungen Progress® Messing für hohe Temperaturen Cable glands Progress® nickel-plated brass for high-temperature applications</p>		<p>34 - 37</p>	<p>3</p>
<p>Kabelverschraubungen Progress® Messing mit Dichteinsatz ohne Bohrung Cable glands Progress® nickel-plated brass with sealing insert without a hole</p>		<p>38 - 39</p>	<p>4</p>
<p>Kabelverschraubungen Progress® Messing für Flachkabel Cable glands Progress® nickel-plated brass for flat cables</p>		<p>40 - 42</p>	<p>5</p>
<p>Kabelverschraubungen Progress® Messing mit speziellem Anschlussgewinde Cable glands Progress® nickel-plated brass with special entry thread</p>		<p>43 - 44</p>	<p>6</p>
<p>Kabelverschraubungen Progress® Messing mit Knickschutztülle EPDM Cable glands Progress® nickel-plated brass with antikink nozzle EPDM</p>		<p>45</p>	<p>7</p>
<p>Kabelverschraubungen Progress® Messing mit Knickschutzfeder Cable glands Progress® nickel-plated brass with anti-kink spring</p>		<p>46 - 47</p>	<p>8</p>
<p>Kabelverschraubungen Progress® Messing mit Klemmbacken Cable glands Progress® nickel-plated brass with clamps</p>		<p>48 - 52</p>	<p>9</p>
<p>Kabelverschraubungen Progress® Messing mit Trompete Cable glands Progress® nickel-plated brass with trumpet-piece</p>		<p>53 - 54</p>	<p>10</p>
<p>Kabelverschraubungen Progress® Messing mit Trompete und Klemmbacken Cable glands Progress® nickel-plated brass with trumpet-piece and clamps</p>		<p>55 - 56</p>	<p>11</p>

Kurzes Anschlussgewinde metrisch | Short entry thread metric

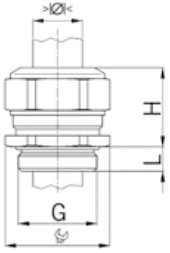

Material: Messing vernickelt
 Dichtung: TPE
 O-Ring: NBR
 Zugentlastung: Ausführung A nach EN 62444
 Schutzart: IP 68 (bis 10 bar) / IP 69
 NEMA Type rating: 4X
 Einsatztemperatur: -40 °C / +100 °C

Material: Nickel-plated brass
 Seal: TPE
 O-ring: NBR
 Strain relief: Version A acc. to EN 62444
 Protection class: IP 68 (up to 10 bar) / IP 69
 NEMA Type rating: 4X
 Operation temperature: -40 °C / +100 °C



Progress MS



Einteiliger Dichteinsatz
 durchgehend isolierend

One-piece sealing insert
 overall length insulated

G	>Ø< min mm	>Ø< max mm	Ø mm	H mm	L mm	i info	Art.-No.	
M6x1.0	2.0	2.5	8	12	5	1	1060.06.025	50
M6x1.0	2.5	3.0	8	12	5	1	1060.06.030	50
M8x1.25	2.5	3.0	11	14	5	1	1060.08.030	50
M8x1.25	3.0	4.0	11	14	5	1	1060.08.040	50
M10x1.5	3.0	4.0	13	15	5	1	1060.10.040	50
M10x1.5	4.0	6.0	13	15	5	1	1060.10.060	50
M12x1.5	3.5	5.0	15	17	5	-	1060.12.050	50
M12x1.5	5.0	6.5	15	17	5	-	1060.12.065	50
M12x1.5	6.5	7.5	15	17	5	-	1060.12.075	50
M16x1.5	4.5	6.0	18	20	5	-	1060.17.060	50
M16x1.5	6.0	8.0	18	20	5	-	1060.17.080	50
M16x1.5	8.0	10.5	18	22	5	-	1060.17.105	50
M20x1.5	6.0	8.0	24	21	6	-	1060.20.080	50
M20x1.5	8.0	11.0	24	21	6	-	1060.20.110	50
M20x1.5	11.0	14.5	24	23	6	-	1060.20.145	50
M25x1.5	9.5	12.5	30	25	7	-	1060.25.125	25
M25x1.5	12.5	16.0	30	25	7	-	1060.25.160	25
M25x1.5	16.0	19.0	30	28	7	-	1060.25.190	25
M32x1.5	17.0	21.0	36	28	8	-	1060.32.210	25
M32x1.5	21.0	25.5	36	28	8	-	1060.32.255	25
M40x1.5	24.0	28.5	46	31	8	-	1060.40.285	10
M40x1.5	28.5	33.0	46	31	8	-	1060.40.330	10
M50x1.5	33.0	37.0	55	34	9	-	1060.50.370	10
M50x1.5	37.0	42.0	55	34	9	-	1060.50.420	10
M63x1.5	40.0	46.0	70	37	10	-	1060.63.460	5
M63x1.5	46.0	52.0	70	37	10	-	1060.63.520	5
M75x1.5	50.0	56.0	80	38	11	-	1060.75.560	1
M75x1.5	56.0	63.0	80	38	11	-	1060.75.630	1

1 = Metrisches Regelgewinde (mit VDE Testreport)

1 = Metric coarse-pitch thread (with VDE test report)

Erhältlich mit Dichteinsatz gemäss EN 45545 / NFPA 130. Bei Anfragen oder Bestellung bitte ein F vor die Artikelnummer setzen.

Available with sealing inserts conformity with EN 45545 / NFPA 130. When placing an inquiry, prefix the article number by the capital F.



Progress MS



Zweiteiliger Dichteinsatz
 durchgehend isolierend

Two-piece sealing insert
 overall length insulated

G	>Ø< min mm	>Ø< max mm	>Ø< min mm	>Ø< max mm	Ø mm	H mm	L mm	Art.-No.	
M16x1.5	6.0	8.0	8.0	10.5	18	22	5	1060.17	50
M20x1.5	8.0	11.0	11.0	14.5	24	23	6	1060.20	50
M25x1.5	12.5	16.0	16.0	19.0	30	28	7	1060.25	25
M32x1.5	17.0	21.0	21.0	25.5	36	28	8	1060.32	25
M40x1.5	24.0	28.5	28.5	33.0	46	31	8	1060.40	10
M50x1.5	33.0	37.0	37.0	42.0	55	34	9	1060.50	10
M63x1.5	41.0	46.0	46.0	52.0	70	37	10	1060.63	5
M75x1.5	50.0	56.0	56.0	63.0	80	38	11	1060.75	1

Erhältlich mit Dichteinsatz gemäss EN 45545 / NFPA 130. Bei Anfragen oder Bestellung bitte ein F vor die Artikelnummer setzen.

Available with sealing inserts conformity with EN 45545 / NFPA 130. When placing an inquiry, prefix the article number by the capital F.

Kurzes Anschlussgewinde metrisch | Short entry thread metric

Material: Messing vernickelt
 Dichtung: TPE / NBR
 O-Ring: NBR
 Zugentlastung: Ausführung A nach EN 62444
 Schutzart: IP 68 (bis 10 bar) / IP 69
 NEMA Type rating: 4X
 Einsatztemperatur: -40 °C / +100 °C

Material: Nickel-plated brass
 Seal: TPE / NBR
 O-ring: NBR
 Strain relief: Version A acc. to EN 62444
 Protection class: IP 68 (up to 10 bar) / IP 69
 NEMA Type rating: 4X
 Operation temperature: -40 °C / +100 °C

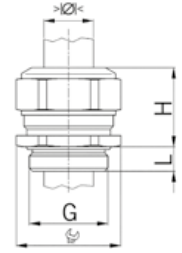

Einteiliger Dichteinsatz
 nicht durchgehend isolierend

One-piece sealing insert
 not overall length insulated

G	>Ø< min mm	>Ø< max mm	mm	H mm	L mm	i info	Art.-No.	
M6x1.0	2.0	2.5	8	12	5	1	1000.06.025	50
M6x1.0	2.5	3.0	8	12	5	1	1000.06.030	50
M6x1.0	3.0	3.5	8	12	5	1	1000.06.035	50
M8x1.25	2.5	3.5	11	14	5	1	1000.08.035	50
M8x1.25	3.5	5.0	11	14	5	1	1000.08.050	50
M10x1.5	3.0	4.0	13	15	5	1	1000.10.040	50
M10x1.5	4.0	6.0	13	15	5	1	1000.10.060	50
M12x1.5	3.5	5.0	15	17	5	-	1000.12.050	50
M12x1.5	5.0	6.5	15	17	5	-	1000.12.065	50
M12x1.5	6.5	8.0	15	17	5	-	1000.12.080	50
M16x1.5	3.5	4.5	18	20	5	-	1000.17.045	50
M16x1.5	4.5	6.0	18	20	5	-	1000.17.060	50
M16x1.5	6.0	8.0	18	20	5	-	1000.17.080	50
M16x1.5	8.0	10.5	18	22	5	-	1000.17.105	50
M20x1.5	6.0	8.0	24	21	6	-	1000.20.080	50
M20x1.5	8.0	11.0	24	21	6	-	1000.20.110	50
M20x1.5	11.0	15.0	24	23	6	-	1000.20.150	50
M25x1.5	9.5	12.5	30	25	7	-	1000.25.125	25
M25x1.5	12.5	16.0	30	27	7	-	1000.25.160	25
M25x1.5	16.0	20.5	30	28	7	-	1000.25.205	25
M32x1.5	14.0	17.0	36	28	8	-	1000.32.170	25
M32x1.5	17.0	21.0	36	28	8	-	1000.32.210	25
M32x1.5	21.0	25.5	36	28	8	-	1000.32.255	25
M40x1.5	20.0	24.0	46	31	8	-	1000.40.240	10
M40x1.5	24.0	28.5	46	31	8	-	1000.40.285	10
M40x1.5	28.5	33.0	46	31	8	-	1000.40.330	10
M50x1.5	29.0	33.0	55	34	9	-	1000.50.330	10
M50x1.5	33.0	37.0	55	34	9	-	1000.50.370	10
M50x1.5	37.0	42.0	55	34	9	-	1000.50.420	10
M63x1.5	35.0	40.0	70	37	10	-	1000.63.400	5
M63x1.5	40.0	46.0	70	37	10	-	1000.63.460	5
M63x1.5	46.0	52.0	70	37	10	-	1000.63.520	5
M75x1.5	45.0	50.0	80	38	11	-	1000.75.500	1
M75x1.5	50.0	56.0	80	38	11	-	1000.75.560	1
M75x1.5	56.0	63.0	80	38	11	-	1000.75.630	1
M85x2.0	63.0	70.0	95	41	18	-	1000.85.700	1
M95x2.0	68.0	75.0	110	51	20	-	1000.95.750	1
M95x2.0	73.0	80.0	110	51	20	-	1000.95.800	1
M100x3.0	78.0	85.0	115	51	22	-	1000.100.850	1
M105x3.0	83.0	90.0	120	52	22	-	1000.105.900	1
M115x3.0	88.0	95.0	125	52	22	-	1000.115.950	1



Progress MS



1 = Metrisches Regelgewinde (mit VDE Testreport)

1 = Metric coarse-pitch thread (with VDE test report)

Erhältlich mit Dichteinsatz gemäss EN 45545 / NFPA 130.
 Bei Anfragen oder Bestellung bitte ein F vor die Artikelnummer setzen.

Available with sealing inserts conformity with EN 45545 / NFPA 130. When placing an inquiry, prefix the article number by the capital F.

Kurzes Anschlussgewinde metrisch | Short entry thread metric

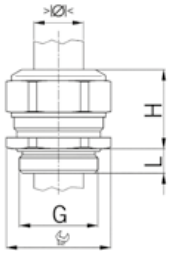

Material: Messing vernickelt
 Dichtung: TPE
 O-Ring: NBR
 Zugentlastung: Ausführung A nach EN 62444
 Schutzart: IP 68 (bis 10 bar) / IP 69
 NEMA Type rating: 4X
 Einsatztemperatur: -40 °C / +100 °C

Material: Nickel-plated brass
 Seal: TPE
 O-ring: NBR
 Strain relief: Version A acc. to EN 62444
 Protection class: IP 68 (up to 10 bar) / IP 69
 NEMA Type rating: 4X
 Operation temperature: -40 °C / +100 °C



Progress MS



Zweiteiliger Dichteinsatz
 nicht durchgehend isolierend

Two-piece sealing insert
 not overall length insulated

G	>math>\varnothing</math> min mm	>math>\varnothing</math> max mm	>math>\varnothing</math> min mm	>math>\varnothing</math> max mm	 mm	H mm	L mm	Art.-No.	
M16x1.5	6.0	8.0	8.0	10.5	18	22	5	1000.17	50
M20x1.5	8.0	11.0	11.0	15.0	24	23	6	1000.20	50
M25x1.5	12.5	16.0	16.0	20.5	30	28	7	1000.25	25
M32x1.5	17.0	21.0	21.0	25.5	36	28	8	1000.32	25
M40x1.5	24.0	28.5	28.5	33.0	46	31	8	1000.40	10
M50x1.5	33.0	37.0	37.0	42.0	55	34	9	1000.50	10
M63x1.5	40.0	46.0	46.0	52.0	70	37	10	1000.63	5
M75x1.5	50.0	56.0	56.0	63.0	80	38	11	1000.75	1

Erhältlich mit Dichteinsatz gemäss EN 45545 / NFPA 130.
 Bei Anfragen oder Bestellung bitte ein F vor die Artikelnummer setzen.

Available with sealing inserts conformity with EN 45545 / NFPA 130. When placing an inquiry, prefix the article number by the capital F.

Langes Anschlussgewinde metrisch | Long entry thread metric

Material: Messing vernickelt
 Dichtung: TPE
 O-Ring: NBR
 Zugentlastung: Ausführung A nach EN 62444
 Schutzart: IP 68 (bis 10 bar) / IP 69
 NEMA Type rating: 4X
 Einsatztemperatur: -40 °C / +100 °C

Material: Nickel-plated brass
 Seal: TPE
 O-ring: NBR
 Strain relief: Version A acc. to EN 62444
 Protection class: IP 68 (up to 10 bar) / IP 69
 NEMA Type rating: 4X
 Operation temperature: -40 °C / +100 °C

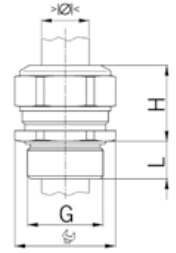

Einteiliger Dichteinsatz durchgehend isolierend

One-piece sealing insert overall length insulated

G	>Ø< min mm	>Ø< max mm	mm	H mm	L mm	i info	Art.-No.	
M6x1.0	2.0	2.5	8	12	8	1	1160.06.025	50
M6x1.0	2.5	3.0	8	12	8	1	1160.06.030	50
M8x1.25	2.5	3.0	11	14	10	1	1160.08.030	50
M8x1.25	3.0	4.0	11	14	10	1	1160.08.040	50
M10x1.5	3.0	4.0	13	15	10	1	1160.10.040	50
M10x1.5	4.0	6.0	13	15	10	1	1160.10.060	50
M12x1.5	3.5	5.0	15	17	10	-	1160.12.050	50
M12x1.5	5.0	6.5	15	17	10	-	1160.12.065	50
M12x1.5	6.5	7.5	15	17	10	-	1160.12.075	50
M16x1.5	8.0	10.5	18	22	10	-	1160.17.105	50
M20x1.5	11.0	14.5	24	23	10	-	1160.20.145	50
M25x1.5	16.0	19.0	30	28	11	-	1160.25.190	25
M32x1.5	21.0	25.5	36	28	13	-	1160.32.255	25
M40x1.5	28.5	33.0	46	34	13	-	1160.40.330	10
M50x1.5	37.0	42.0	55	34	14	-	1160.50.420	10
M63x1.5	46.0	52.0	70	37	14	-	1160.63.520	5
M75x1.5	56.0	63.0	80	38	15	-	1160.75.630	1



Progress MS



1 = Metrisches Regelgewinde (mit VDE Testreport)

1 = Metric coarse-pitch thread (with VDE test report)

Erhältlich mit Dichteinsatz gemäss EN 45545 / NFPA 130. Bei Anfragen oder Bestellung bitte ein F vor die Artikelnummer setzen.

Available with sealing inserts conformity with EN 45545 / NFPA 130. When placing an inquiry, prefix the article number by the capital F.

Zweiteiliger Dichteinsatz durchgehend isolierend

Two-piece sealing insert overall length insulated

G	>Ø< min mm	>Ø< max mm	>Ø< min mm	>Ø< max mm	mm	H mm	L mm	Art.-No.	
M16x1.5	6.0	8.0	8.0	10.5	18	22	10	1160.17	50
M20x1.5	8.0	11.0	11.0	14.5	24	23	10	1160.20	50
M25x1.5	12.5	16.0	16.0	19.0	30	28	11	1160.25	25
M32x1.5	17.0	21.0	21.0	25.5	36	28	13	1160.32	25
M40x1.5	24.0	28.5	28.5	33.0	46	31	13	1160.40	10
M50x1.5	33.0	37.0	37.0	42.0	55	34	14	1160.50	10
M63x1.5	41.0	46.0	46.0	52.0	70	37	14	1160.63	5
M75x1.5	50.0	56.0	56.0	63.0	80	38	15	1160.75	1



Progress MS



Erhältlich mit Dichteinsatz gemäss EN 45545 / NFPA 130. Bei Anfragen oder Bestellung bitte ein F vor die Artikelnummer setzen.

Available with sealing inserts conformity with EN 45545 / NFPA 130. When placing an inquiry, prefix the article number by the capital F.

1
2
3
4
5
6
7
8
9
10
11
12
13
14
15

Langes Anschlussgewinde metrisch | Long entry thread metric

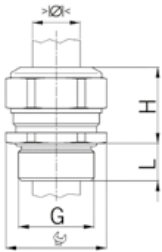

Material: Messing vernickelt
 Dichtung: TPE
 O-Ring: NBR
 Zugentlastung: Ausführung A nach EN 62444
 Schutzart: IP 68 (bis 10 bar) / IP 69
 NEMA Type rating: 4X
 Einsatztemperatur: -40 °C / +100 °C

Material: Nickel-plated brass
 Seal: TPE
 O-ring: NBR
 Strain relief: Version A acc. to EN 62444
 Protection class: IP 68 (up to 10 bar) / IP 69
 NEMA Type rating: 4X
 Operation temperature: -40 °C / +100 °C



Progress MS



Einteiliger Dichteinsatz
 nicht durchgehend isolierend

One-piece sealing insert
 not overall length insulated

G	>Ø< min mm	>Ø< max mm	mm	H mm	L mm	i info	Art.-No.	
M6x1.0	2.0	2.5	8	12	8	1	1100.06.025	50
M6x1.0	2.5	3.0	8	12	8	1	1100.06.030	50
M6x1.0	3.0	3.5	8	12	8	1	1100.06.035	50
M8x1.25	2.5	3.5	11	14	10	1	1100.08.035	50
M8x1.25	3.5	5.0	11	14	10	1	1100.08.050	50
M10x1.5	3.0	4.0	13	15	10	1	1100.10.040	50
M10x1.5	4.0	6.0	13	15	10	1	1100.10.060	50
M12x1.5	3.5	5.0	15	17	10	-	1100.12.050	50
M12x1.5	5.0	6.5	15	17	10	-	1100.12.065	50
M12x1.5	6.5	8.0	15	17	10	-	1100.12.080	50
M16x1.5	3.5	4.5	18	20	10	-	1100.17.045	50
M16x1.5	4.5	6.0	18	20	10	-	1100.17.060	50
M16x1.5	6.0	8.0	18	20	10	-	1100.17.080	50
M16x1.5	8.0	10.5	18	22	10	-	1100.17.105	50
M20x1.5	6.0	8.0	24	21	10	-	1100.20.080	50
M20x1.5	8.0	11.0	24	21	10	-	1100.20.110	50
M20x1.5	11.0	15.0	24	23	10	-	1100.20.150	50
M25x1.5	9.5	12.5	30	25	11	-	1100.25.125	25
M25x1.5	12.5	16.0	30	27	11	-	1100.25.160	25
M25x1.5	16.0	20.5	30	28	11	-	1100.25.205	25
M32x1.5	14.0	17.0	36	28	13	-	1100.32.170	25
M32x1.5	17.0	21.0	36	28	13	-	1100.32.210	25
M32x1.5	21.0	25.5	36	28	13	-	1100.32.255	25
M40x1.5	20.0	24.0	46	31	13	-	1100.40.240	10
M40x1.5	24.0	28.5	46	31	13	-	1100.40.285	10
M40x1.5	28.5	33.0	46	31	13	-	1100.40.330	10
M50x1.5	29.0	33.0	55	34	14	-	1100.50.330	10
M50x1.5	33.0	37.0	55	34	14	-	1100.50.370	10
M50x1.5	37.0	42.0	55	34	14	-	1100.50.420	10
M63x1.5	35.0	40.0	70	37	14	-	1100.63.400	5
M63x1.5	40.0	46.0	70	37	14	-	1100.63.460	5
M63x1.5	46.0	52.0	70	37	14	-	1100.63.520	5
M75x1.5	45.0	50.0	80	38	15	-	1100.75.500	1
M75x1.5	50.0	56.0	80	38	15	-	1100.75.560	1
M75x1.5	56.0	63.0	80	38	15	-	1100.75.630	1

1 = Metrisches Regelgewinde (mit VDE Testreport)

1 = Metric coarse-pitch thread (with VDE test report)

Erhältlich mit Dichteinsatz gemäss EN 45545 / NFPA 130.
 Bei Anfragen oder Bestellung bitte ein F vor die Artikelnummer setzen.

Available with sealing inserts conformity with EN 45545 / NFPA 130. When placing an inquiry, prefix the article number by the capital F.

Langes Anschlussgewinde metrisch | Long entry thread metric

Material: Messing vernickelt
 Dichtung: TPE
 O-Ring: NBR
 Zugentlastung: Ausführung A nach EN 62444
 Schutzart: IP 68 (bis 10 bar) / IP 69
 NEMA Type rating: 4X
 Einsatztemperatur: -40 °C / +100 °C

Material: Nickel-plated brass
 Seal: TPE
 O-ring: NBR
 Strain relief: Version A acc. to EN 62444
 Protection class: IP 68 (up to 10 bar) / IP 69
 NEMA Type rating: 4X
 Operation temperature: -40 °C / +100 °C

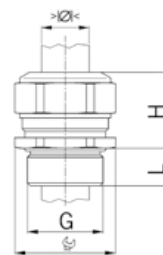

Zweiteiliger Dichteinsatz
 nicht durchgehend isolierend

Two-piece sealing insert
 not overall length insulated

G	>Ø<		>Ø<		mm	H mm	L mm	Art.-No.	
	min mm	max mm	min mm	max mm					
M16x1.5	6.0	8.0	8.0	10.5	18	22	10	1100.17	50
M20x1.5	8.0	11.0	11.0	15.0	24	23	10	1100.20	50
M25x1.5	12.5	16.0	16.0	20.5	30	28	11	1100.25	25
M32x1.5	17.0	21.0	21.0	25.5	36	28	13	1100.32	25
M40x1.5	24.0	28.5	28.5	33.0	46	31	13	1100.40	10
M50x1.5	33.0	37.0	37.0	42.0	55	34	14	1100.50	10
M63x1.5	40.0	46.0	46.0	52.0	70	37	14	1100.63	5
M75x1.5	50.0	56.0	56.0	63.0	80	38	15	1100.75	1

Erhältlich mit Dichteinsatz gemäss EN 45545 / NFPA 130.
 Bei Anfragen oder Bestellung bitte ein F vor die Artikelnummer setzen.

Available with sealing inserts conformity with EN 45545 / NFPA 130. When placing an inquiry, prefix the article number by the capital F.



Progress MS



Kurzes Anschlussgewinde Pg | Short entry thread Pg

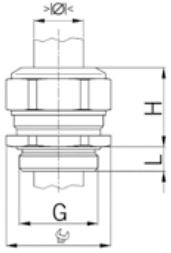

Material: Messing vernickelt
 Dichtung: TPE
 O-Ring: NBR
 Schutzart: IP 68 (bis 10 bar) / IP 69
 NEMA Type rating: 4X
 Einsatztemperatur: -40 °C / +100 °C

Material: Nickel-plated brass
 Seal: TPE
 O-ring: NBR
 Protection class: IP 68 (up to 10 bar) / IP 69
 NEMA Type rating: 4X
 Operation temperature: -40 °C / +100 °C



Progress MS



Einteiliger Dichteinsatz
 durchgehend isolierend

One-piece sealing insert
 overall length insulated

G	$\begin{matrix} > \text{Ø} < \\ \text{min mm} \end{matrix}$	$\begin{matrix} > \text{Ø} < \\ \text{max mm} \end{matrix}$	$\begin{matrix} \text{Ø} \\ \text{mm} \end{matrix}$	H	L	Art.-No.	
	min mm	max mm	mm	mm	mm		
Pg 7	3.5	5.0	15	17	6.0	1060.07.050	50
Pg 7	5.0	6.5	15	17	6.0	1060.07.065	50
Pg 7	6.5	7.5	15	17	6.0	1060.07.075	50
Pg 9	4.5	6.0	18	20	6.0	1060.09.060	50
Pg 9	6.0	8.0	18	20	6.0	1060.09.080	50
Pg 9	8.0	10.5	18	22	6.0	1060.09.105	50
Pg 11	4.0	5.5	21	21	6.0	1060.11.055	50
Pg 11	5.5	8.5	21	21	6.0	1060.11.085	50
Pg 11	8.5	12.0	21	21	6.0	1060.11.120	50
Pg 13	6.0	8.0	24	21	6.0	1060.13.080	50
Pg 13	8.0	11.0	24	21	6.0	1060.13.110	50
Pg 13	11.0	14.5	24	23	6.0	1060.13.145	50
Pg 16	6.0	8.0	24	23	6.0	1060.16.080	50
Pg 16	8.0	11.0	24	23	6.0	1060.16.110	50
Pg 16	11.0	14.5	24	23	6.0	1060.16.145	50
Pg 21	9.5	12.5	30	28	7.5	1060.21.125	25
Pg 21	12.5	16.0	30	28	7.5	1060.21.160	25
Pg 21	16.0	19.0	30	28	7.5	1060.21.190	25
Pg 29	19.0	23.0	38	28	8.0	1060.29.230	25
Pg 29	23.0	27.5	38	28	8.0	1060.29.275	25
Pg 36	26.0	30.5	50	32	8.0	1060.36.305	10
Pg 36	30.5	35.0	50	32	8.0	1060.36.350	10
Pg 42	33.0	37.0	55	34	10.0	1060.42.370	10
Pg 42	37.0	42.0	55	34	10.0	1060.42.420	10
Pg 48	37.0	43.0	65	37	11.0	1060.48.430	10
Pg 48	43.0	49.0	65	37	11.0	1060.48.490	10

Erhältlich mit Dichteinsatz gemäss EN 45545 / NFPA 130.
 Bei Anfragen oder Bestellung bitte ein F vor die Artikelnummer setzen.

Available with sealing inserts conformity with EN 45545 / NFPA 130. When placing an inquiry, prefix the article number by the capital F.



Progress MS



Zweiteiliger Dichteinsatz
 durchgehend isolierend

Two-piece sealing insert
 overall length insulated

G	$\begin{matrix} > \text{Ø} < \\ \text{min mm} \end{matrix}$	$\begin{matrix} > \text{Ø} < \\ \text{max mm} \end{matrix}$	$\begin{matrix} > \text{Ø} < \\ \text{min mm} \end{matrix}$	$\begin{matrix} > \text{Ø} < \\ \text{max mm} \end{matrix}$	$\begin{matrix} \text{Ø} \\ \text{mm} \end{matrix}$	H	L	Art.-No.	
	min mm	max mm	min mm	max mm	mm	mm	mm		
Pg 9	6.0	8.0	8.0	10.5	18	22	6.0	1060.09	50
Pg 11	5.5	8.5	8.5	12.0	21	21	6.0	1060.11	50
Pg 13	8.0	11.0	11.0	14.5	24	23	6.0	1060.13	50
Pg 16	8.0	11.0	11.0	14.5	24	23	6.0	1060.16	50
Pg 21	12.5	16.0	16.0	19.0	30	28	7.5	1060.21	25
Pg 29	19.0	23.0	23.0	27.5	38	28	8.0	1060.29	25
Pg 36	26.0	30.5	30.5	35.0	50	32	8.0	1060.36	10
Pg 42	33.0	37.0	37.0	42.0	55	34	10.0	1060.42	10
Pg 48	37.0	43.0	43.0	49.0	65	37	11.0	1060.48	10

Erhältlich mit Dichteinsatz gemäss EN 45545 / NFPA 130.
 Bei Anfragen oder Bestellung bitte ein F vor die Artikelnummer setzen.

Available with sealing inserts conformity with EN 45545 / NFPA 130. When placing an inquiry, prefix the article number by the capital F.

Kurzes Anschlussgewinde Pg | Short entry thread Pg

Material: Messing vernickelt
 Dichtung: TPE
 O-Ring: NBR
 Schutzart: IP 68 (bis 10 bar) / IP 69
 NEMA Type rating: 4X
 Einsatztemperatur: -40 °C / +100 °C

Material: Nickel-plated brass
 Seal: TPE
 O-ring: NBR
 Protection class: IP 68 (up to 10 bar) / IP 69
 NEMA Type rating: 4X
 Operation temperature: -40 °C / +100 °C

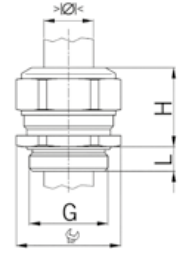

Einteiliger Dichteinsatz
 nicht durchgehend isolierend

One-piece sealing insert
 not overall length insulated

G	> Q <	> Q <	Q	H	L	Art.-No.	
	min mm	max mm	mm	mm	mm		
Pg 7	3.5	5.0	15	17	6.0	1000.07.050	50
Pg 7	5.0	6.5	15	17	6.0	1000.07.065	50
Pg 7	6.5	8.0	15	17	6.0	1000.07.080	50
Pg 9	3.5	4.5	18	20	6.0	1000.09.045	50
Pg 9	4.5	6.0	18	20	6.0	1000.09.060	50
Pg 9	6.0	8.0	18	20	6.0	1000.09.080	50
Pg 9	8.0	10.5	18	22	6.0	1000.09.105	50
Pg 11	4.0	5.5	21	21	6.0	1000.11.055	50
Pg 11	5.5	8.5	21	21	6.0	1000.11.085	50
Pg 11	8.5	12.0	21	21	6.0	1000.11.120	50
Pg 13	6.0	8.0	24	21	6.0	1000.13.080	50
Pg 13	8.0	11.0	24	21	6.0	1000.13.110	50
Pg 13	11.0	15.0	24	23	6.0	1000.13.150	50
Pg 16	6.0	8.0	24	23	6.0	1000.16.080	50
Pg 16	8.0	11.0	24	23	6.0	1000.16.110	50
Pg 16	11.0	15.0	24	23	6.0	1000.16.150	50
Pg 21	9.5	12.5	30	28	7.5	1000.21.125	25
Pg 21	12.5	16.0	30	28	7.5	1000.21.160	25
Pg 21	16.0	20.5	30	28	7.5	1000.21.205	25
Pg 29	16.0	19.0	38	28	8.0	1000.29.190	25
Pg 29	19.0	23.0	38	28	8.0	1000.29.230	25
Pg 29	23.0	27.5	38	28	8.0	1000.29.275	25
Pg 36	21.5	26.0	50	32	8.0	1000.36.260	10
Pg 36	26.0	30.5	50	32	8.0	1000.36.305	10
Pg 36	30.5	35.0	50	32	8.0	1000.36.350	10
Pg 42	29.0	33.0	55	34	10.0	1000.42.330	10
Pg 42	33.0	37.0	55	34	10.0	1000.42.370	10
Pg 42	37.0	42.0	55	34	10.0	1000.42.420	10
Pg 48	32.0	37.0	65	37	11.0	1000.48.370	5
Pg 48	37.0	43.0	65	37	11.0	1000.48.430	5
Pg 48	43.0	49.0	65	37	11.0	1000.48.490	5

Erhältlich mit Dichteinsatz gemäss EN 45545 / NFPA 130.
 Bei Anfragen oder Bestellung bitte ein F vor die Artikelnummer setzen.

Available with sealing inserts conformity with EN 45545 / NFPA 130. When placing an inquiry, prefix the article number by the capital F.



Progress MS



Kurzes Anschlussgewinde Pg | Short entry thread Pg

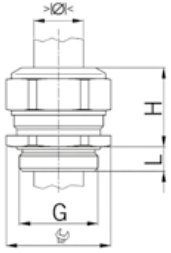

Material: Messing vernickelt
 Dichtung: TPE
 O-Ring: NBR
 Schutzart: IP 68 (bis 10 bar) / IP 69
 NEMA Type rating: 4X
 Einsatztemperatur: -40 °C / +100 °C

Material: Nickel-plated brass
 Seal: TPE
 O-ring: NBR
 Protection class: IP 68 (up to 10 bar) / IP 69
 NEMA Type rating: 4X
 Operation temperature: -40 °C / +100 °C



Progress MS



Zweiteiliger Dichteinsatz
 nicht durchgehend isolierend

Two-piece sealing insert
 not overall length insulated

G	\varnothing		\varnothing		$\frac{H}{h}$	H	L	Art.-No.	
	min mm	max mm	min mm	max mm					
Pg 9	6.0	8.0	8.0	10.5	18	22	6.0	1000.09	50
Pg 11	5.5	8.5	8.5	12.0	21	21	6.0	1000.11	50
Pg 13	8.0	11.0	11.0	15.0	24	23	6.0	1000.13	50
Pg 16	8.0	11.0	11.0	15.0	24	23	6.0	1000.16	50
Pg 21	12.5	16.0	16.0	20.5	30	28	7.5	1000.21	25
Pg 29	19.0	23.0	23.0	27.5	38	28	8.0	1000.29	25
Pg 36	26.0	30.5	30.5	35.0	50	32	8.0	1000.36	10
Pg 42	33.0	37.0	37.0	42.0	55	34	10.0	1000.42	10
Pg 48	37.0	43.0	43.0	49.0	65	37	11.0	1000.48	10

Erhältlich mit Dichteinsatz gemäss EN 45545 / NFPA 130.
 Bei Anfragen oder Bestellung bitte ein F vor die Artikelnummer setzen.

Available with sealing inserts conformity with EN 45545 / NFPA 130. When placing an inquiry, prefix the article number by the capital F.

Langes Anschlussgewinde Pg | Long entry thread Pg

Material: Messing vernickelt
 Dichtung: TPE
 O-Ring: NBR
 Schutzart: IP 68 (bis 10 bar) / IP 69
 NEMA Type rating: 4X
 Einsatztemperatur: -40 °C / +100 °C

Material: Nickel-plated brass
 Seal: TPE
 O-ring: NBR
 Protection class: IP 68 (up to 10 bar) / IP 69
 NEMA Type rating: 4X
 Operation temperature: -40 °C / +100 °C

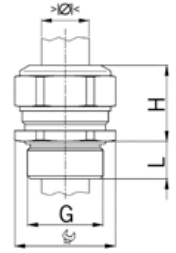

Einteiliger Dichteinsatz
 durchgehend isolierend

One-piece sealing insert
 overall length insulated

G	>10<	>10<	mm	H	L	Art.-No.	
	min mm	max mm	mm	mm	mm		
Pg 7	5.0	6.5	15	17	10	1160.07.065	50
Pg 7	6.5	7.5	15	17	10	1160.07.075	50
Pg 9	8.0	10.5	18	22	10	1160.09.105	50
Pg 11	8.5	12.0	21	21	10	1160.11.120	50
Pg 13	11.0	14.5	24	23	10	1160.13.145	50
Pg 16	11.0	14.5	24	23	10	1160.16.145	50
Pg 21	16.0	19.0	30	28	12	1160.21.190	25
Pg 29	23.0	27.5	38	28	12	1160.29.275	25
Pg 36	30.5	35.0	50	32	15	1160.36.350	10
Pg 42	37.0	42.0	55	32	15	1160.42.420	10
Pg 48	43.0	49.0	65	37	15	1160.48.490	10

Erhältlich mit Dichteinsatz gemäss EN 45545 / NFPA 130.
 Bei Anfragen oder Bestellung bitte ein F vor die Artikelnummer setzen.

Available with sealing inserts conformity with EN 45545 / NFPA 130. When placing an inquiry, prefix the article number by the capital F.



Progress MS



Zweiteiliger Dichteinsatz
 durchgehend isolierend

Two-piece sealing insert
 overall length insulated

G	>10<	>10<	>10<	>10<	mm	H	L	Art.-No.	
	min mm	max mm	min mm	max mm	mm	mm	mm		
Pg 9	6.0	8.0	8.0	10.5	18	22	10	1160.09	50
Pg 11	5.5	8.5	8.5	12.0	21	21	10	1160.11	50
Pg 13	8.0	11.0	11.0	14.5	24	23	10	1160.13	50
Pg 16	8.0	11.0	11.0	14.5	24	23	10	1160.16	50
Pg 21	12.5	16.0	16.0	19.0	30	28	12	1160.21	25
Pg 29	19.0	23.0	23.0	27.5	38	28	12	1160.29	25
Pg 36	26.0	30.5	30.5	35.0	50	32	15	1160.36	10
Pg 42	33.0	37.0	37.0	42.0	55	34	15	1160.42	10
Pg 48	37.0	43.0	43.0	49.0	65	37	15	1160.48	10

Erhältlich mit Dichteinsatz gemäss EN 45545 / NFPA 130.
 Bei Anfragen oder Bestellung bitte ein F vor die Artikelnummer setzen.

Available with sealing inserts conformity with EN 45545 / NFPA 130. When placing an inquiry, prefix the article number by the capital F.



Progress MS



Langes Anschlussgewinde Pg | Long entry thread Pg

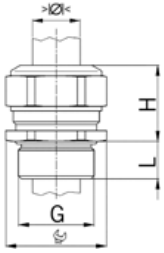

Material: Messing vernickelt
 Dichtung: TPE
 O-Ring: NBR
 Schutzart: IP 68 (bis 10 bar) / IP 69
 NEMA Type rating: 4X
 Einsatztemperatur: -40 °C / +100 °C

Material: Nickel-plated brass
 Seal: TPE
 O-ring: NBR
 Protection class: IP 68 (up to 10 bar) / IP 69
 NEMA Type rating: 4X
 Operation temperature: -40 °C / +100 °C



Progress MS



Einteiliger Dichteinsatz
 nicht durchgehend isolierend

One-piece sealing insert
 not overall length insulated

G	>D< min mm	>D< max mm	H mm	L mm	Art.-No.	
Pg 7	3.5	5.0	15	17	1100.07.050	50
Pg 7	5.0	6.5	15	17	1100.07.065	50
Pg 7	6.5	8.0	15	17	1100.07.080	50
Pg 9	3.5	4.5	18	20	1100.09.045	50
Pg 9	4.5	6.0	18	20	1100.09.060	50
Pg 9	6.0	8.0	18	20	1100.09.080	50
Pg 9	8.0	10.5	18	22	1100.09.105	50
Pg 11	4.0	5.5	21	21	1100.11.055	50
Pg 11	5.5	8.5	21	21	1100.11.085	50
Pg 11	8.5	12.0	21	21	1100.11.120	50
Pg 13	6.0	8.0	24	21	1100.13.080	50
Pg 13	8.0	11.0	24	21	1100.13.110	50
Pg 13	11.0	15.0	24	23	1100.13.150	50
Pg 16	6.0	8.0	24	23	1100.16.080	50
Pg 16	8.0	11.0	24	23	1100.16.110	50
Pg 16	11.0	15.0	24	23	1100.16.150	50
Pg 21	9.5	12.5	30	28	1100.21.125	25
Pg 21	12.5	16.0	30	28	1100.21.160	25
Pg 21	16.0	20.5	30	28	1100.21.205	25
Pg 29	16.0	19.0	38	28	1100.29.190	25
Pg 29	19.0	23.0	38	28	1100.29.230	25
Pg 29	23.0	27.5	38	28	1100.29.275	25
Pg 36	21.5	26.0	50	32	1100.36.260	10
Pg 36	26.0	30.5	50	32	1100.36.305	10
Pg 36	30.5	35.0	50	32	1100.36.350	10
Pg 42	29.0	33.0	55	34	1100.42.330	10
Pg 42	33.0	37.0	55	34	1100.42.370	10
Pg 42	37.0	42.0	55	34	1100.42.420	10
Pg 48	32.0	37.0	65	37	1100.48.370	10
Pg 48	37.0	43.0	65	37	1100.48.430	10
Pg 48	43.0	49.0	65	37	1100.48.490	10

Erhältlich mit Dichteinsatz gemäss EN 45545 / NFPA 130.
 Bei Anfragen oder Bestellung bitte ein F vor die Artikelnummer setzen.

Available with sealing inserts conformity with EN 45545 / NFPA 130. When placing an inquiry, prefix the article number by the capital F.

Langes Anschlussgewinde Pg | Long entry thread Pg

Material: Messing vernickelt
 Dichtung: TPE
 O-Ring: NBR
 Schutzart: IP 68 (bis 10 bar) / IP 69
 NEMA Type rating: 4X
 Einsatztemperatur: -40 °C / +100 °C

Material: Nickel-plated brass
 Seal: TPE
 O-ring: NBR
 Protection class: IP 68 (up to 10 bar) / IP 69
 NEMA Type rating: 4X
 Operation temperature: -40 °C / +100 °C

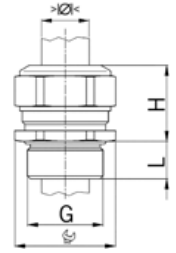

Zweiteiliger Dichteinsatz
 nicht durchgehend isolierend

Two-piece sealing insert
 not overall length insulated

G	Ø		Ø		H mm	L mm	Art.-No.	📦
	min mm	max mm	min mm	max mm				
Pg 9	6.0	8.0	8.0	10.5	18	22	1100.09	50
Pg 11	5.5	8.5	8.5	12.0	21	21	1100.11	50
Pg 13	8.0	11.0	11.0	15.0	24	23	1100.13	50
Pg 16	8.0	11.0	11.0	15.0	24	23	1100.16	50
Pg 21	12.5	16.0	16.0	20.5	30	28	1100.21	25
Pg 29	19.0	23.0	23.0	27.5	38	28	1100.29	25
Pg 36	26.0	30.5	30.5	35.0	50	32	1100.36	10
Pg 42	33.0	37.0	37.0	42.0	55	34	1100.42	10
Pg 48	37.0	43.0	43.0	49.0	65	37	1100.48	10

Erhältlich mit Dichteinsatz gemäss EN 45545 / NFPA 130.
 Bei Anfragen oder Bestellung bitte ein F vor die Artikelnummer setzen.

Available with sealing inserts conformity with EN 45545 / NFPA 130. When placing an inquiry, prefix the article number by the capital F.



Progress MS



Anschlussgewinde NPT | Entry thread NPT

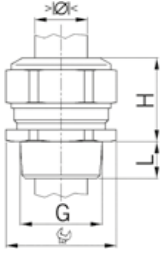

Material: Messing vernickelt
 Dichtung: TPE
 Schutzart: IP 68 (bis 10 bar) / IP 69
 Gewinde: IP 68, wenn Anschlussgewinde abgedichtet
 NEMA Type rating: 4X
 Einsatztemperatur: -40 °C / +100 °C

Material: Nickel-plated brass
 Seal: TPE
 Protection class: IP 68 (up to 10 bar) / IP 69
 Entry thread: IP 68, if the entry thread is sealed
 NEMA Type rating: 4X
 Operation temperature: -40 °C / +100 °C



Progress MS NPT



Einteiliger Dichteinsatz
 nicht durchgehend isolierend

One-piece sealing insert
 not overall length insulated

G	>Ø< min mm	>Ø< max mm	Ø mm	H mm	L mm	Art.-No.	
NPT 1/8"	3.0	4.0	13	15	8	1000.1/8NPT.040	50
NPT 1/8"	4.0	6.0	13	15	8	1000.1/8NPT.060	50
NPT 1/4"	3.5	5.0	15	17	12	1000.1/4NPT.050	50
NPT 1/4"	5.0	6.5	15	17	12	1000.1/4NPT.065	50
NPT 1/4"	6.5	8.0	15	17	12	1000.1/4NPT.080	50
NPT 3/8"	3.5	4.5	18	20	12	1000.3/8NPT.045	50
NPT 3/8"	4.5	6.0	18	20	12	1000.3/8NPT.060	50
NPT 3/8"	6.0	8.0	18	20	12	1000.3/8NPT.080	50
NPT 3/8"	8.0	10.5	18	22	12	1000.3/8NPT.105	50
NPT 1/2"	6.0	8.0	24	21	15	1000.1/2NPT.080	50
NPT 1/2"	8.0	11.0	24	21	15	1000.1/2NPT.110	50
NPT 1/2"	11.0	15.0	24	23	15	1000.1/2NPT.150	50
NPT 3/4"	9.5	12.5	30	28	15	1000.3/4NPT.125	25
NPT 3/4"	12.5	16.0	30	28	15	1000.3/4NPT.160	25
NPT 3/4"	16.0	20.5	30	28	15	1000.3/4NPT.205	25
NPT 1"	14.0	17.0	36	28	20	1000.1NPT.170	25
NPT 1"	17.0	21.0	36	28	20	1000.1NPT.210	25
NPT 1"	21.0	25.5	36	28	20	1000.1NPT.255	25
NPT 1 1/4"	20.0	24.0	46	31	20	1000.11/4NPT.240	10
NPT 1 1/4"	24.0	28.5	46	31	20	1000.11/4NPT.285	10
NPT 1 1/4"	28.5	33.0	46	31	20	1000.11/4NPT.330	10
NPT 1 1/2"	29.0	33.0	55	34	22	1000.11/2NPT.330	10
NPT 1 1/2"	33.0	37.0	55	34	22	1000.11/2NPT.370	10
NPT 1 1/2"	37.0	41.0	55	34	22	1000.11/2NPT.410	10
NPT 2"	35.0	40.0	70	37	22	1000.2NPT.400	5
NPT 2"	40.0	46.0	70	37	22	1000.2NPT.460	5
NPT 2"	46.0	52.0	70	37	22	1000.2NPT.520	5



Progress MS NPT



Zweiteiliger Dichteinsatz
 nicht durchgehend isolierend

Two-piece sealing insert
 not overall length insulated

G	>Ø< min mm	>Ø< max mm	>Ø< min mm	>Ø< max mm	Ø mm	H mm	L mm	Art.-No.	
NPT 3/8"	6.0	8.0	8.0	10.5	18	22	12	1000.3/8NPT	50
NPT 1/2"	8.0	11.0	11.0	15.0	24	23	15	1000.1/2NPT	50
NPT 3/4"	12.5	16.0	16.0	20.5	30	28	15	1000.3/4NPT	25
NPT 1"	17.0	21.0	21.0	25.5	36	28	20	1000.1NPT	25
NPT 1 1/4"	24.0	28.5	28.5	33.0	46	31	20	1000.11/4NPT	10
NPT 1 1/2"	33.0	37.0	37.0	41.0	55	34	22	1000.11/2NPT	10
NPT 2"	40.0	46.0	46.0	52.0	70	37	22	1000.2NPT	5

Anschlussgewinde Gasrohr | Gas-pipe entry thread

Material: Messing vernickelt
 Dichtung: TPE
 O-Ring: NBR
 Schutzart: IP 68
 Einsatztemperatur: -40 °C / +100 °C

Material: Nickel-plated brass
 Seal: TPE
 O-ring: NBR
 Protection class: IP 68
 Operation temperature: -40 °C / +100 °C

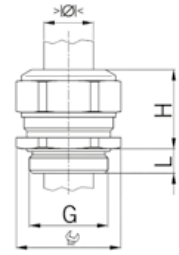

Zweiteiliger Dichteinsatz
 nicht durchgehend isolierend

Two-piece sealing insert
 not overall length insulated

G	>Ø< min mm	>Ø< max mm	>Ø< min mm	>Ø< max mm	Ø mm	H mm	L mm	i info	Art.-No.	
G 3/8"	5.5	8.5	8.5	12.0	21	21	6	-	1000.3/8G	50
G 1/2"	8.0	11.0	11.0	15.0	24	23	8	-	1000.1/2G	50
G 3/4"	12.5	16.0	16.0	20.5	30	28	10	-	1000.3/4G	25
G 1"	17.0	21.0	21.0	25.5	36	28	11	-	1000.1G	25
G 1 1/2"	25.0	30.5	30.5	35.0	55/50	32	12	-	1000.11/2G	10
G 2"	37.0	43.0	43.0	49.0	65	37	12	-	1000.2G	10
G 2 1/2"	-	-	45.0	50.0	80	38	18	1	1000.21/2G.500	1
G 2 1/2"	-	-	50.0	56.0	80	38	18	1	1000.21/2G.560	1
G 3"	-	-	56.0	63.0	80	38	18	1	1000.3G.630	1
G 3"	-	-	63.0	70.0	95	40	18	1	1000.3G.700	1

1 = Einteiliger Dichteinsatz

1 = One-piece sealing insert

Kabelverschraubungen Progress® Messing für mehrere Kabel

Cable glands Progress® nickel-plated brass for installation of multiple cables

Kurzes Anschlussgewinde metrisch | Short entry thread metric

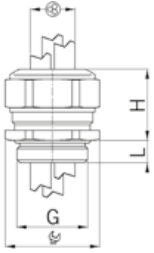

Material: Messing vernickelt
 Dichtung: TPE
 O-Ring: NBR
 Zugentlastung: Ausführung A nach EN 62444
 Schutzart: IP 68
 Einsatztemperatur: -40 °C / +100 °C

Material: Nickel-plated brass
 Seal: TPE
 O-ring: NBR
 Strain relief: Version A acc. to EN 62444
 Protection class: IP 68
 Operation temperature: -40 °C / +100 °C



Progress MS Multi



Einteiliger Dichteinsatz
 nicht durchgehend isolierend

One-piece sealing insert
 not overall length insulated

G	$\begin{matrix} > \text{Ø} < \\ \text{min mm} \end{matrix}$	$\begin{matrix} > \text{Ø} < \\ \text{max mm} \end{matrix}$	$\begin{matrix} \text{⊗} \\ \text{mm} \end{matrix}$	$\begin{matrix} \text{Ⓜ} \\ \text{mm} \end{matrix}$	H	L	Art.-No.	
M16x1.5	2.0	3.0	2	18	22	5	1310.17.2.030	50
M16x1.5	2.5	4.0	2	18	22	5	1310.17.2.040	50
M16x1.5	3.5	5.0	2	18	22	5	1310.17.2.050	50
M20x1.5	3.5	5.0	2	24	23	6	1310.20.2.050	50
M20x1.5	4.5	6.0	2	24	23	6	1310.20.2.060	50
M20x1.5	5.5	7.5	2	24	23	6	1310.20.2.075	50
M20x1.5	3.5	5.0	3	24	23	6	1310.20.3.050	50
M20x1.5	4.5	6.0	3	24	23	6	1310.20.3.060	50
M20x1.5	5.2	6.5	3	24	23	6	1310.20.3.065	50
M20x1.5	3.5	5.0	4	24	23	6	1310.20.4.050	50
M20x1.5	4.5	6.0	4	24	23	6	1310.20.4.060	50
M25x1.5	5.0	7.0	2	30	28	7	1310.25.2.070	25
M25x1.5	6.7	9.0	2	30	28	7	1310.25.2.090	25
M25x1.5	7.7	10.0	2	30	28	7	1310.25.2.100	25
M25x1.5	5.5	7.0	3	30	28	7	1310.25.3.070	25
M25x1.5	6.8	9.0	3	30	28	7	1310.25.3.090	25
M25x1.5	5.5	7.0	4	30	28	7	1310.25.4.070	25
M25x1.5	4.8	6.0	6	30	28	7	1310.25.6.060	25
M32x1.5	9.0	11.5	2	36	28	8	1310.32.2.115	25
M32x1.5	7.0	9.0	3	36	28	8	1310.32.3.090	25
M32x1.5	8.5	10.5	3	36	28	8	1310.32.3.105	25
M32x1.5	7.0	9.0	4	36	28	8	1310.32.4.090	25
M32x1.5	5.8	7.0	6	36	28	8	1310.32.6.070	25

Weitere Ausführungen und Anschlussgewinde auf Anfrage

Further versions and entry threads are available upon request.

Erhältlich mit Dichteinsatz gemäss EN 45545 / NFPA 130. Bei Anfragen oder Bestellung bitte ein F vor die Artikelnummer setzen.

Available with sealing inserts conformity with EN 45545 / NFPA 130. When placing an inquiry, prefix the article number by the capital F.



Einteiliger Dichteinsatz
 nicht durchgehend isolierend

One-piece sealing insert
 not overall length insulated

G	$\begin{matrix} > \text{Ø} < \\ \text{min mm} \end{matrix}$	$\begin{matrix} > \text{Ø} < \\ \text{max mm} \end{matrix}$	$\begin{matrix} \text{⊗} \\ \text{mm} \end{matrix}$	$\begin{matrix} \text{Ⓜ} \\ \text{mm} \end{matrix}$	H	L	i	Art.-No.	
M40x1.5	12.5	14.0	2	46	31	8	1	1310.40.2.140	10
M40x1.5	10.5	12.0	4	46	31	8	1	1310.40.4.120	10
M40x1.5	6.5	8.0	6	46	31	8	1	1310.40.6.080	10
M50x1.5	6.5	8.0	7	55	34	9	1	1310.50.7.080	10
M50x1.5	8.5	10.0	4	55	34	9	1	1310.50.4.100	10
M63x1.5	13.5	15.0	4	70	37	10	1	1310.63.4.150	5
M63x1.5	8.5	10.0	8	70	37	10	1	1310.63.8.100	5
M75x1.5	16.5	18.0	6	80	38	11	-	1310.75.6.180	1

Weitere Ausführungen und Anschlussgewinde auf Anfrage

Further versions and entry threads are available upon request.

1= NBR Dichtung

1= NBR Seal

Erhältlich mit Dichteinsatz gemäss EN 45545 / NFPA 130. Bei Anfragen oder Bestellung bitte ein F vor die Artikelnummer setzen.

Available with sealing inserts conformity with EN 45545 / NFPA 130. When placing an inquiry, prefix the article number by the capital F.

Kabelverschraubungen Progress® Messing für mehrere Kabel Cable glands Progress® nickel-plated brass for installation of multiple cables

Langes Anschlussgewinde metrisch | Long entry thread metric

Material: Messing vernickelt
Dichtung: TPE
O-Ring: NBR
Zugentlastung: Ausführung A nach EN 62444
Schutzart: IP 68
Einsatztemperatur: -40 °C / +100 °C

Material: Nickel-plated brass
Seal: TPE
O-ring: NBR
Strain relief: Version A acc. to EN 62444
Protection class: IP 68
Operation temperature: -40 °C / +100 °C

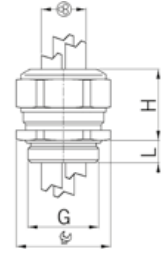

Einteiliger Dichteinsatz
nicht durchgehend isolierend

One-piece sealing insert
not overall length insulated

G	>Ø< min mm	>Ø< max mm	⊗ mm	⊗ mm	H mm	L mm	Art.-No.	
M16x1.5	2.0	3.0	2	18	22	10	1311.17.2.030	50
M16x1.5	2.5	4.0	2	18	22	10	1311.17.2.040	50
M16x1.5	3.5	5.0	2	18	22	10	1311.17.2.050	50
M20x1.5	3.5	5.0	2	24	23	10	1311.20.2.050	50
M20x1.5	4.5	6.0	2	24	23	10	1311.20.2.060	50
M20x1.5	5.5	7.5	2	24	23	10	1311.20.2.075	50
M20x1.5	3.5	5.0	3	24	23	10	1311.20.3.050	50
M20x1.5	4.5	6.0	3	24	23	10	1311.20.3.060	50
M20x1.5	5.2	6.5	3	24	23	10	1311.20.3.065	50
M20x1.5	3.5	5.0	4	24	23	10	1311.20.4.050	50
M20x1.5	4.5	6.0	4	24	23	10	1311.20.4.060	50
M25x1.5	5.0	7.0	2	30	28	11	1311.25.2.070	25
M25x1.5	6.7	9.0	2	30	28	11	1311.25.2.090	25
M25x1.5	7.7	10.0	2	30	28	11	1311.25.2.100	25
M25x1.5	5.5	7.0	3	30	28	11	1311.25.3.070	25
M25x1.5	6.8	9.0	3	30	28	11	1311.25.3.090	25
M25x1.5	5.5	7.0	4	30	28	11	1311.25.4.070	25
M25x1.5	4.8	6.0	6	30	28	11	1311.25.6.060	25
M32x1.5	9.0	11.5	2	36	28	13	1311.32.2.115	25
M32x1.5	7.0	9.0	3	36	28	13	1311.32.3.090	25
M32x1.5	8.5	10.5	3	36	28	13	1311.32.3.105	25
M32x1.5	7.0	9.0	4	36	28	13	1311.32.4.090	25
M32x1.5	5.8	7.0	6	36	28	13	1311.32.6.070	25

Weitere Ausführungen und Anschlussgewinde
auf Anfrage

Further versions and entry threads
are available upon request.

Erhältlich mit Dichteinsatz gemäss EN 45545 / NFPA 130.
Bei Anfragen oder Bestellung bitte ein F vor die Artikel-
nummer setzen.

Available with sealing inserts conformity with EN 45545 /
NFPA 130. When placing an inquiry, prefix the article
number by the capital F.



Progress MS Multi



Einteiliger Dichteinsatz
nicht durchgehend isolierend

One-piece sealing insert
not overall length insulated

G	>Ø< min mm	>Ø< max mm	⊗ mm	⊗ mm	H mm	L mm	i info	Art.-No.	
M40x1.5	12.5	14.0	2	46	31	13	1	1311.40.2.140	10
M40x1.5	10.5	12.0	4	46	31	13	1	1311.40.4.120	10
M40x1.5	6.5	8.0	6	46	31	13	1	1311.40.6.080	10
M50x1.5	8.5	10.0	4	55	34	14	1	1311.50.4.100	10
M50x1.5	6.5	8.0	7	55	34	14	1	1311.50.7.080	10
M63x1.5	13.5	15.0	4	70	37	14	1	1311.63.4.150	5
M63x1.5	8.5	10.0	8	70	37	14	1	1311.63.8.100	5
M75x1.5	16.5	18.0	6	80	38	15	-	1311.75.6.180	1

Weitere Ausführungen und Anschlussgewinde
auf Anfrage

Further versions and entry threads
are available upon request.

1= NBR Dichtung

1= NBR Seal

Erhältlich mit Dichteinsatz gemäss EN 45545 / NFPA 130.
Bei Anfragen oder Bestellung bitte ein F vor die Artikel-
nummer setzen.

Available with sealing inserts conformity with EN 45545 /
NFPA 130. When placing an inquiry, prefix the article
number by the capital F.



Kurzes Anschlussgewinde Pg | Short entry thread Pg

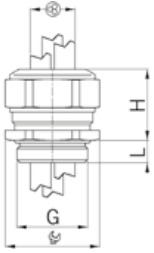

Material: Messing vernickelt
 Dichtung: TPE
 O-Ring: NBR
 Schutzart: IP 68
 Einsatztemperatur: -40 °C / +100 °C

Material: Nickel-plated brass
 Seal: TPE
 O-ring: NBR
 Protection class: IP 68
 Operation temperature: -40 °C / +100 °C



Einteiliger Dichteinsatz
 nicht durchgehend isolierend

One-piece sealing insert
 not overall length insulated

G	$\gt;\varnothing<$ min mm	$\gt;\varnothing<$ max mm			H mm	L mm	Art.-No.	
Pg 9	2.0	3.0	2	18	22	6.0	1310.09.2.030	50
Pg 9	2.5	4.0	2	18	22	6.0	1310.09.2.040	50
Pg 9	3.5	5.0	2	18	22	6.0	1310.09.2.050	50
Pg 11	3.5	5.0	2	21	21	6.0	1310.11.2.050	50
Pg 11	4.5	6.0	2	21	21	6.0	1310.11.2.060	50
Pg 11	5.5	7.5	2	24	23	6.0	1310.11.2.075	50
Pg 11	3.5	5.0	3	21	21	6.0	1310.11.3.050	50
Pg 13	3.5	5.0	2	24	23	6.0	1310.13.2.050	50
Pg 13	4.5	6.0	2	24	23	6.0	1310.13.2.060	50
Pg 13	5.5	7.5	2	24	23	6.0	1310.13.2.075	50
Pg 13	3.5	5.0	3	24	23	6.0	1310.13.3.050	50
Pg 13	4.5	6.0	3	24	23	6.0	1310.13.3.060	50
Pg 13	5.2	6.5	3	24	23	6.0	1310.13.3.065	50
Pg 13	3.5	5.0	4	24	23	6.0	1310.13.4.050	50
Pg 13	4.5	6.0	4	24	23	6.0	1310.13.4.060	50
Pg 16	3.5	5.0	2	24	23	6.0	1310.16.2.050	50
Pg 16	4.5	6.0	2	24	23	6.0	1310.16.2.060	50
Pg 16	5.5	7.5	2	24	23	6.0	1310.16.2.075	50
Pg 16	6.7	9.0	2	30	28	6.0	1310.16.2.090	25
Pg 16	3.5	5.0	3	24	23	6.0	1310.16.3.050	50
Pg 16	4.5	6.0	3	24	23	6.0	1310.16.3.060	50
Pg 16	5.0	7.0	3	30	28	6.0	1310.16.3.070	25
Pg 16	3.5	5.0	4	24	23	6.0	1310.16.4.050	50
Pg 16	4.5	6.0	4	24	23	6.0	1310.16.4.060	50
Pg 16	5.5	7.0	4	30	28	6.0	1310.16.4.070	25
Pg 21	5.0	7.0	2	30	28	7.5	1310.21.2.070	25
Pg 21	6.7	9.0	2	30	28	7.5	1310.21.2.090	25
Pg 21	7.7	10.0	2	30	28	7.5	1310.21.2.100	25
Pg 21	9.0	11.5	2	36	28	7.5	1310.21.2.115	25
Pg 21	5.5	7.0	3	30	28	7.5	1310.21.3.070	25
Pg 21	6.8	9.0	3	30	28	7.5	1310.21.3.090	25
Pg 21	8.5	10.5	3	36	28	7.5	1310.21.3.105	25
Pg 21	5.5	7.0	4	30	28	7.5	1310.21.4.070	25
Pg 21	7.0	9.0	4	36	28	7.5	1310.21.4.090	25
Pg 21	4.8	6.0	6	30	28	7.5	1310.21.6.060	25
Pg 21	5.8	7.0	6	36	28	7.5	1310.21.6.070	25
Pg 29	7.5	9.0	3	38	28	8.0	1310.29.3.090	25

Weitere Ausführungen und Anschlussgewinde auf Anfrage

Further versions and entry threads are available upon request.

Erhältlich mit Dichteinsatz gemäss EN 45545 / NFPA 130. Bei Anfragen oder Bestellung bitte ein F vor die Artikelnummer setzen.

Available with sealing inserts conformity with EN 45545 / NFPA 130. When placing an inquiry, prefix the article number by the capital F.

Kabelverschraubungen Progress® Messing für mehrere Kabel Cable glands Progress® nickel-plated brass for installation of multiple cables

Langes Anschlussgewinde Pg | Long entry thread Pg

Material: Messing vernickelt
Dichtung: TPE
O-Ring: NBR
Schutzart: IP 68
Einsatztemperatur: -40 °C / +100 °C

Material: Nickel-plated brass
Seal: TPE
O-ring: NBR
Protection class: IP 68
Operation temperature: -40 °C / +100 °C

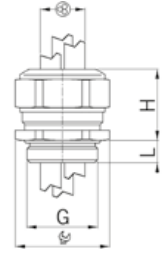

Einteiliger Dichteinsatz
nicht durchgehend isolierend

One-piece sealing insert
not overall length insulated

G	$\text{>}\varnothing\text{<}$ min mm	$\text{>}\varnothing\text{<}$ max mm			H mm	L mm	Art.-No.	
Pg 9	2.0	3.0	2	18	22	10	1311.09.2.030	50
Pg 9	2.5	4.0	2	18	22	10	1311.09.2.040	50
Pg 9	3.5	5.0	2	18	22	10	1311.09.2.050	50
Pg 11	3.5	5.0	2	21	21	10	1311.11.2.050	50
Pg 11	4.5	6.0	2	21	21	10	1311.11.2.060	50
Pg 11	5.5	7.5	2	24	23	10	1311.11.2.075	50
Pg 11	3.5	5.0	3	21	21	10	1311.11.3.050	50
Pg 13	3.5	5.0	2	24	23	10	1311.13.2.050	50
Pg 13	4.5	6.0	2	24	23	10	1311.13.2.060	50
Pg 13	5.5	7.5	2	24	23	10	1311.13.2.075	50
Pg 13	3.5	5.0	3	24	23	10	1311.13.3.050	50
Pg 13	4.5	6.0	3	24	23	10	1311.13.3.060	50
Pg 13	5.2	6.5	3	24	23	10	1311.13.3.065	50
Pg 13	3.5	5.0	4	24	23	10	1311.13.4.050	50
Pg 13	4.5	6.0	4	24	23	10	1311.13.4.060	50
Pg 16	3.5	5.0	2	24	23	10	1311.16.2.050	50
Pg 16	4.5	6.0	2	24	23	10	1311.16.2.060	50
Pg 16	5.5	7.5	2	24	23	10	1311.16.2.075	50
Pg 16	6.7	9.0	2	30	28	10	1311.16.2.090	25
Pg 16	3.5	5.0	3	24	23	10	1311.16.3.050	50
Pg 16	4.5	6.0	3	24	23	10	1311.16.3.060	50
Pg 16	5.0	7.0	3	30	28	10	1311.16.3.070	25
Pg 16	3.5	5.0	4	24	23	10	1311.16.4.050	50
Pg 16	4.5	6.0	4	24	23	10	1311.16.4.060	50
Pg 16	5.5	7.0	4	30	28	10	1311.16.4.070	25
Pg 21	5.0	7.0	2	30	28	12	1311.21.2.070	25
Pg 21	6.7	9.0	2	30	28	12	1311.21.2.090	25
Pg 21	7.7	10.0	2	30	28	12	1311.21.2.100	25
Pg 21	9.0	11.5	2	36	28	12	1311.21.2.115	25
Pg 21	5.5	7.0	3	30	28	12	1311.21.3.070	25
Pg 21	6.8	9.0	3	30	28	12	1311.21.3.090	25
Pg 21	8.5	10.5	3	36	28	12	1311.21.3.105	25
Pg 21	5.5	7.0	4	30	28	12	1311.21.4.070	25
Pg 21	7.0	9.0	4	36	28	12	1311.21.4.090	25
Pg 21	4.8	6.0	6	30	28	12	1311.21.6.060	25
Pg 21	5.8	7.0	6	36	28	12	1311.21.6.070	25
Pg 29	7.5	9.0	3	38	28	12	1311.29.3.090	25

Weitere Ausführungen und Anschlussgewinde
auf Anfrage

Further versions and entry threads
are available upon request.

Erhältlich mit Dichteinsatz gemäss EN 45545 / NFPA 130.
Bei Anfragen oder Bestellung bitte ein F vor die Artikel-
nummer setzen.

Available with sealing inserts conformity with EN 45545 /
NFPA 130. When placing an inquiry, prefix the article
number by the capital F.

Kabelverschraubungen Progress® Messing für hohe Temperaturen

Cable glands Progress® nickel-plated brass for high temperature applications

Kurzes Anschlussgewinde metrisch | Short entry thread metric

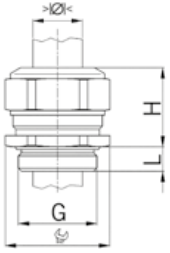

Material: Messing vernickelt
 Dichtung: FPM
 O-Ring: FPM
 Zugentlastung: Ausführung A nach EN 62444
 Schutzart: IP 68 (bis 10 bar) / IP 69
 Einsatztemperatur: -40 °C / +200 °C

Material: Nickel-plated brass
 Seal: FPM
 O-ring: FPM
 Strain relief: Version A acc. to EN 62444
 Protection class: IP 68 (up to 10 bar) / IP 69
 Operation temperature: -40 °C / +200 °C



Einteiliger Dichteinsatz
 nicht durchgehend isolierend

One-piece sealing insert
 not overall length insulated

G	>math>\varnothing</math> min mm	>math>\varnothing</math> max mm	>math>\varnothing</math> mm	H mm	L mm	i info	Art.-No.	
M6x1.0	2.0	2.5	8	12	5	1	1000.06.91.025	50
M6x1.0	2.5	3.0	8	12	5	1	1000.06.91.030	50
M6x1.0	3.0	3.5	8	12	5	1	1000.06.91.035	50
M8x1.25	2.5	3.5	11	14	5	1	1000.08.91.035	50
M8x1.25	3.5	5.0	11	14	5	1	1000.08.91.050	50
M10x1.5	3.0	4.0	13	15	5	1	1000.10.91.040	50
M10x1.5	4.0	6.0	13	15	5	1	1000.10.91.060	50
M12x1.5	3.5	5.0	15	17	5	-	1000.12.91.050	50
M12x1.5	5.0	6.5	15	17	5	-	1000.12.91.065	50
M12x1.5	6.5	8.0	15	17	5	-	1000.12.91.080	50
M16x1.5	8.0	10.5	18	22	5	-	1000.17.91.105	50
M20x1.5	11.0	15.0	24	23	6	-	1000.20.91.150	50
M25x1.5	16.0	20.5	30	28	7	-	1000.25.91.205	25
M32x1.5	21.0	25.5	36	28	8	-	1000.32.91.255	25
M40x1.5	28.5	33.0	46	31	8	-	1000.40.91.330	10
M50x1.5	37.0	42.0	55	34	9	-	1000.50.91.420	10
M63x1.5	46.0	52.0	70	37	10	-	1000.63.91.520	5

1 = Metrisches Regelgewinde (mit VDE Testreport)

1 = Metric coarse-pitch thread (with VDE test report)

Progress MS HT



Zweiteiliger Dichteinsatz
 nicht durchgehend isolierend

Two-piece sealing insert
 not overall length insulated

G	>math>\varnothing</math> min mm	>math>\varnothing</math> max mm	>math>\varnothing</math> min mm	>math>\varnothing</math> max mm	>math>\varnothing</math> mm	H mm	L mm	Art.-No.	
M16x1.5	6.0	8.0	8.0	10.5	18	22	5	1000.17.92	50
M20x1.5	8.0	11.0	11.0	15.0	24	23	6	1000.20.92	50
M25x1.5	12.5	16.0	16.0	20.5	30	28	7	1000.25.92	25
M32x1.5	17.0	21.0	21.0	25.5	36	28	8	1000.32.92	25
M40x1.5	24.0	28.5	28.5	33.0	46	31	8	1000.40.92	10
M50x1.5	33.0	37.0	37.0	42.0	55	34	9	1000.50.92	10
M63x1.5	40.0	46.0	46.0	52.0	70	37	10	1000.63.92	5

Progress MS HT



Kabelverschraubungen Progress® Messing für hohe Temperaturen Cable glands Progress® nickel-plated brass for high temperature applications

Langes Anschlussgewinde metrisch | Long entry thread metric

Material:	Messing vernickelt	Material:	Nickel-plated brass
Dichtung:	FPM	Seal:	FPM
O-Ring:	FPM	O-ring:	FPM
Zugentlastung:	Ausführung A nach EN 62444	Strain relief:	Version A acc. to EN 62444
Schutzart:	IP 68 (bis 10 bar) / IP 69	Protection class:	IP 68 (up to 10 bar) / IP 69
Einsatztemperatur:	-40 °C / +200 °C	Operation temperature:	-40 °C / +200 °C

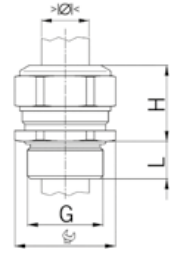

Einteiliger Dichteinsatz
nicht durchgehend isolierend

One-piece sealing insert
not overall length insulated

G	>Ø< min mm	>Ø< max mm	Ø mm	H mm	L mm	i info	Art.-No.	
M6x1.0	2.0	2.5	8	12	8	1	1100.06.91.025	50
M6x1.0	2.5	3.0	8	12	8	1	1100.06.91.030	50
M6x1.0	3.0	3.5	8	12	8	1	1100.06.91.035	50
M8x1.25	2.5	3.5	11	14	10	1	1100.08.91.035	50
M8x1.25	3.5	5.0	11	14	10	1	1100.08.91.050	50
M10x1.5	3.0	4.0	13	15	10	1	1100.10.91.040	50
M10x1.5	4.0	6.0	13	15	10	1	1100.10.91.060	50
M12x1.5	3.5	5.0	15	17	10	-	1100.12.91.050	50
M12x1.5	5.0	6.5	15	17	10	-	1100.12.91.065	50
M12x1.5	6.5	8.0	15	17	10	-	1100.12.91.080	50
M16x1.5	8.0	10.5	18	22	10	-	1100.17.91.105	50
M20x1.5	11.0	15.0	24	23	10	-	1100.20.91.150	50
M25x1.5	16.0	20.5	30	28	11	-	1100.25.91.205	25
M32x1.5	21.0	25.5	36	28	13	-	1100.32.91.255	25
M40x1.5	28.5	33.0	46	31	13	-	1100.40.91.330	10
M50x1.5	37.0	42.0	55	34	14	-	1100.50.91.420	10
M63x1.5	46.0	52.0	70	37	14	-	1100.63.91.520	5



Progress MS HT



1 = Metrisches Regelgewinde (mit VDE Testreport)

1 = Metric coarse-pitch thread (with VDE test report)

Zweiteiliger Dichteinsatz
nicht durchgehend isolierend

Two-piece sealing insert
not overall length insulated

G	>Ø< min mm	>Ø< max mm	>Ø< min mm	>Ø< max mm	Ø mm	H mm	L mm	Art.-No.	
M16x1.5	6.0	8.0	8.0	10.5	18	22	10	1100.17.92	50
M20x1.5	8.0	11.0	11.0	15.0	24	23	10	1100.20.92	50
M25x1.5	12.5	16.0	16.0	20.5	30	28	11	1100.25.92	25
M32x1.5	17.0	21.0	21.0	25.5	36	28	13	1100.32.92	25
M40x1.5	24.0	28.5	28.5	33.0	46	31	13	1100.40.92	10
M50x1.5	33.0	37.0	37.0	42.0	55	34	14	1100.50.92	10
M63x1.5	40.0	46.0	46.0	52.0	70	37	14	1100.63.92	5



Progress MS HT



Kabelverschraubungen Progress® Messing für hohe Temperaturen

Cable glands Progress® nickel-plated brass for high temperature applications

Kurzes Anschlussgewinde Pg | Short entry thread Pg

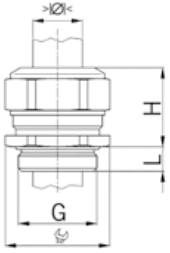

Material: Messing vernickelt
 Dichtung: FPM
 O-Ring: FPM
 Schutzart: IP 68 (bis 10 bar) / IP 69
 Einsatztemperatur: -40 °C / +200 °C

Material: Nickel-plated brass
 Seal: FPM
 O-ring: FPM
 Protection class: IP 68 (up to 10 bar) / IP 69
 Operation temperature: -40 °C / +200 °C



Einteiliger Dichteinsatz
 nicht durchgehend isolierend

One-piece sealing insert
 not overall length insulated

G	>math>\varnothing</math> min mm	>math>\varnothing</math> max mm	>math>\varnothing</math> mm	H mm	L mm	Art.-No.	
Pg 7	3.5	5.0	15	17	6	1000.07.91.050	50
Pg 7	5.0	6.5	15	17	6	1000.07.91.065	50
Pg 7	6.5	8.0	15	17	6	1000.07.91.080	50
Pg 9	8.0	10.5	18	22	6	1000.09.91.105	50
Pg 11	8.5	12.0	21	21	6	1000.11.91.120	50
Pg 13	11.0	15.0	24	23	6	1000.13.91.150	50
Pg 16	11.0	15.0	24	23	6	1000.16.91.150	50
Pg 21	16.0	20.5	30	28	7	1000.21.91.205	25
Pg 29	23.0	27.5	38	28	8	1000.29.91.275	25
Pg 36	30.5	35.0	50	32	8	1000.36.91.350	10
Pg 42	37.0	42.0	55	34	10	1000.42.91.420	10
Pg 48	43.0	49.0	65	37	11	1000.48.91.490	10



Zweiteiliger Dichteinsatz
 nicht durchgehend isolierend

Two-piece sealing insert
 not overall length insulated

G	>math>\varnothing</math> min mm	>math>\varnothing</math> max mm	>math>\varnothing</math> min mm	>math>\varnothing</math> max mm	H mm	L mm	Art.-No.		
Pg 9	6.0	8.0	8.0	10.5	18	22	6	1000.09.92	50
Pg 11	5.5	8.5	8.5	12.0	21	21	6	1000.11.92	50
Pg 13	8.0	11.0	11.0	15.0	24	23	6	1000.13.92	50
Pg 16	8.0	11.0	11.0	15.0	24	23	6	1000.16.92	50
Pg 21	12.5	16.0	16.0	20.5	30	28	7	1000.21.92	25
Pg 29	19.0	23.0	23.0	27.5	38	28	8	1000.29.92	25
Pg 36	26.0	30.5	30.5	35.0	50	32	8	1000.36.92	10
Pg 42	33.0	37.0	37.0	42.0	55	34	10	1000.42.92	10
Pg 48	37.0	43.0	43.0	49.0	65	37	11	1000.48.92	10

Kabelverschraubungen Progress® Messing für hohe Temperaturen Cable glands Progress® nickel-plated brass for high temperature applications

Langes Anschlussgewinde Pg | Long entry thread Pg

Material: Messing vernickelt
Dichtung: FPM
O-Ring: FPM
Schutzart: IP 68 (bis 10 bar) / IP 69
Einsatztemperatur: -40 °C / +200 °C

Material: Nickel-plated brass
Seal: FPM
O-ring: FPM
Protection class: IP 68 (up to 10 bar) / IP 69
Operation temperature: -40 °C / +200 °C

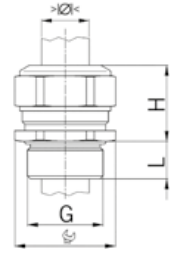

Einteiliger Dichteinsatz
nicht durchgehend isolierend

One-piece sealing insert
not overall length insulated

G	> Ø <	> Ø <	⊕	H	L	Art.-No.	
	min mm	max mm	mm	mm	mm		
Pg 7	3.5	5.0	15	17	10	1100.07.91.050	50
Pg 7	5.0	6.5	15	17	10	1100.07.91.065	50
Pg 7	6.5	8.0	15	17	10	1100.07.91.080	50
Pg 9	8.0	10.5	18	22	10	1100.09.91.105	50
Pg 11	8.5	12.0	21	21	10	1100.11.91.120	50
Pg 13	11.0	15.0	24	23	10	1100.13.91.150	50
Pg 16	11.0	15.0	24	23	10	1100.16.91.150	50
Pg 21	16.0	20.5	30	28	12	1100.21.91.205	25
Pg 29	23.0	27.5	38	28	12	1100.29.91.275	25
Pg 36	30.5	35.0	50	32	15	1100.36.91.350	10
Pg 42	37.0	42.0	55	34	15	1100.42.91.420	10
Pg 48	43.0	49.0	65	37	15	1100.48.91.490	10



Zweiteiliger Dichteinsatz
nicht durchgehend isolierend

Two-piece sealing insert
not overall length insulated

G	> Ø <	> Ø <	> Ø <	> Ø <	⊕	H	L	Art.-No.	
	min mm	max mm	min mm	max mm	mm	mm	mm		
Pg 9	6.0	8.0	8.0	10.5	18	22	10	1100.09.92	50
Pg 11	5.5	8.5	8.5	12.0	21	21	10	1100.11.92	50
Pg 13	8.0	11.0	11.0	15.0	24	23	10	1100.13.92	50
Pg 16	8.0	11.0	11.0	15.0	24	23	10	1100.16.92	50
Pg 21	12.5	16.0	16.0	20.5	30	28	12	1100.21.92	25
Pg 29	19.0	23.0	23.0	27.5	38	28	12	1100.29.92	25
Pg 36	26.0	30.5	30.5	35.0	50	32	15	1100.36.92	10
Pg 42	33.0	37.0	37.0	42.0	55	34	15	1100.42.92	10
Pg 48	37.0	43.0	43.0	49.0	65	37	15	1100.48.92	10



Kabelverschraubungen Progress® Messing mit Dichteinsatz ohne Bohrung

Cable glands Progress® nickel-plated brass with sealing insert without drilled hole

Kurzes Anschlussgewinde metrisch | Short entry thread metric

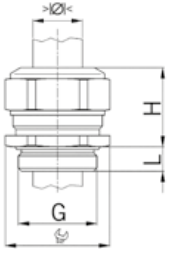

Material: Messing vernickelt
 Dichtung: NBR, ohne Bohrung
 O-Ring: NBR
 Schutzart: IP 68 (bis 10 bar) / IP 69
 Einsatztemperatur: -40 °C / +100 °C

Material: Nickel-plated brass
 Seal: NBR, without drilled hole
 O-ring: NBR
 Protection class: IP 68 (up to 10 bar) / IP 69
 Operation temperature: -40 °C / +100 °C



Einteiliger Dichteinsatz ohne Bohrung
 nicht durchgehend isolierend

One-piece solid sealing insert
 not overall length insulated

G	\varnothing max mm	\varnothing mm	H mm	L mm	i info	Art.-No.	
M6x1.0	3.5	8	12	5	1	1000.06.30	50
M8x1.25	5.0	11	14	5	1	1000.08.30	50
M10x1.5	6.0	13	15	5	1	1000.10.30	50
M12x1.5	8.0	15	17	5	-	1000.12.30	50
M16x1.5	10.5	18	22	5	-	1000.17.30	50
M20x1.5	15.0	24	23	6	-	1000.20.30	50
M25x1.5	20.5	30	28	7	-	1000.25.30	25
M32x1.5	25.5	36	28	8	-	1000.32.30	25
M40x1.5	33.0	46	31	8	-	1000.40.30	10
M50x1.5	42.0	55	34	9	-	1000.50.30	10
M63x1.5	52.0	70	37	10	-	1000.63.30	5

1 = Metrisches Regelgewinde

1 = Metric coarse-pitch thread

Erhältlich mit Dichteinsatz gemäss EN 45545 / NFPA 130.
 Bei Anfragen oder Bestellung bitte ein F vor die Artikelnummer setzen.

Available with sealing inserts conformity with EN 45545 / NFPA 130. When placing an inquiry, prefix the article number by the capital F.

Dichteinsätze ohne Bohrung lassen sich gut bearbeiten, wenn sie vorher auf mindestens -25°C gefroren wurden.

When frozen to at least -25°C, the solid sealing inserts are easy to drill.

Kurzes Anschlussgewinde Pg | Short entry thread Pg



Einteiliger Dichteinsatz ohne Bohrung
 nicht durchgehend isolierend

One-piece solid sealing insert
 not overall length insulated

G	\varnothing max mm	\varnothing mm	H mm	L mm	Art.-No.	
Pg 7	8.0	15	17	6.0	1000.07.30	50
Pg 9	10.5	18	22	6.0	1000.09.30	50
Pg 11	12.0	21	21	6.0	1000.11.30	50
Pg 11	15.0	24	23	6.0	1000.11.20.30	50
Pg 13	15.0	24	23	6.0	1000.13.30	50
Pg 16	15.0	24	23	6.0	1000.16.30	50
Pg 16	18.5	30	28	6.0	1000.16.25.30	25
Pg 21	20.5	30	28	7.5	1000.21.30	25
Pg 21	23.0	36	28	7.5	1000.21.32.30	25
Pg 29	27.5	38	28	8.0	1000.29.30	25
Pg 29	33.0	46	31	8.0	1000.29.40.30	25
Pg 36	35.0	50	32	8.0	1000.36.30	10
Pg 36	42.0	55	34	8.0	1000.36.50.30	10
Pg 42	42.0	55	34	10.0	1000.42.30	10
Pg 48	49.0	65	37	11.0	1000.48.30	10

Erhältlich mit Dichteinsatz gemäss EN 45545 / NFPA 130.
 Bei Anfragen oder Bestellung bitte ein F vor die Artikelnummer setzen.

Available with sealing inserts conformity with EN 45545 / NFPA 130. When placing an inquiry, prefix the article number by the capital F.

Dichteinsätze ohne Bohrung lassen sich gut bearbeiten, wenn sie vorher auf mindestens -25°C gefroren wurden.

When frozen to at least -25°C, the solid sealing inserts are easy to drill.

Kabelverschraubungen Progress® Messing mit Dichteinsatz ohne Bohrung

Cable glands Progress® nickel-plated brass with sealing insert without drilled hole

Kurzes Anschlussgewinde metrisch | Short entry thread metric

Material: Messing vernickelt
 Dichtung: FPM, ohne Bohrung
 O-Ring: FPM
 Schutzart: IP 68 (bis 10 bar) / IP 69
 Einsatztemperatur: -40 °C / +200 °C

Material: Nickel-plated brass
 Seal: FPM, without drilled hole
 O-ring: FPM
 Protection class: IP 68 (up to 10 bar) / IP 69
 Operation temperature: -40 °C / +200 °C

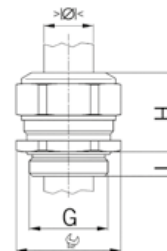

Für hohe Temperaturen
 Einteiliger Dichteinsatz ohne Bohrung
 nicht durchgehend isolierend

For high temperature applications
 One-piece solid sealing insert
 not overall length insulated

G	\varnothing max mm	\varnothing mm	H mm	L mm	i info	Art.-No.	
M6x1.0	3.5	8	12	5	1	1000.06.30.91	50
M8x1.25	5.0	11	14	5	1	1000.08.30.91	50
M10x1.5	6.0	13	15	5	1	1000.10.30.91	50
M12x1.5	8.0	15	17	5	-	1000.12.30.91	50
M16x1.5	10.5	18	22	5	-	1000.17.30.91	50
M20x1.5	15.0	24	23	6	-	1000.20.30.91	50
M25x1.5	20.5	30	28	7	-	1000.25.30.91	25
M32x1.5	25.5	36	28	8	-	1000.32.30.91	25
M40x1.5	33.0	46	31	8	-	1000.40.30.91	10
M50x1.5	42.0	55	34	9	-	1000.50.30.91	10
M63x1.5	52.0	70	37	10	-	1000.63.30.91	5

1 = Metrisches Regelgewinde

1 = Metric coarse-pitch thread

Dichteinsätze ohne Bohrung lassen sich gut bearbeiten,
 wenn sie vorher auf mindestens -25°C gefroren wurden.

When frozen to at least -25°C, the solid sealing inserts are
 easy to drill.



Kurzes Anschlussgewinde Pg | Short entry thread Pg

Für hohe Temperaturen
 Einteiliger Dichteinsatz ohne Bohrung
 nicht durchgehend isolierend

For high temperature applications
 One-piece solid sealing insert
 not overall length insulated

G	\varnothing max mm	\varnothing mm	H mm	L mm	Art.-No.	
Pg 7	8.0	15	17	6.0	1000.07.30.91	50
Pg 9	10.5	18	22	6.0	1000.09.30.91	50
Pg 11	12.0	21	21	6.0	1000.11.30.91	50
Pg 11	15.0	24	23	6.0	1000.11.20.30.91	50
Pg 13	15.0	24	23	6.0	1000.13.30.91	50
Pg 16	15.0	24	23	6.0	1000.16.30.91	50
Pg 16	18.5	30	28	6.0	1000.16.25.30.91	25
Pg 21	20.5	30	28	7.5	1000.21.30.91	25
Pg 21	23.0	36	28	7.5	1000.21.32.30.91	25
Pg 29	27.5	38	28	8.0	1000.29.30.91	25
Pg 29	33.0	46	31	8.0	1000.29.40.30.91	25
Pg 36	35.0	50	32	8.0	1000.36.30.91	10
Pg 36	42.0	55	34	8.0	1000.36.50.30.91	10
Pg 42	42.0	55	34	10.0	1000.42.30.91	10
Pg 48	49.0	65	37	11.0	1000.48.30.91	10

Dichteinsätze ohne Bohrung lassen sich gut bearbeiten,
 wenn sie vorher auf mindestens -25°C gefroren wurden.

When frozen to at least -25°C, the solid sealing inserts are
 easy to drill.



Kabelverschraubungen Progress® Messing für Flachkabel

Cable glands Progress® nickel-plated brass for flat cables

Kurzes Anschlussgewinde metrisch | Short entry thread metric

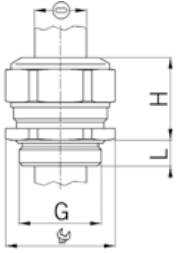

Material: Messing vernickelt
 Dichtung: TPE
 O-Ring: NBR
 Zugentlastung: Ausführung A nach EN 62444
 Schutzart: IP 68
 Einsatztemperatur: -40 °C / +100 °C

Material: Nickel-plated brass
 Seal: TPE
 O-ring: NBR
 Strain relief: Version A acc. to EN 62444
 Protection class: IP 68
 Operation temperature: -40 °C / +100 °C



Progress MS FK



Einteiliger Dichteinsatz
 nicht durchgehend isolierend

One-piece sealing insert
 not overall length insulated

G	min mm	max mm	lay mm	H mm	L mm	Art.-No.	
M16x1.5	7.3x2.5	9.0x4.2	18	22	5	1300.17.090.042	50
M20x1.5	10.5x2.5	13.0x5.0	24	23	6	1300.20.130.050	50
M20x1.5	12.5x2.5	15.0x5.0	24	23	6	1300.20.150.050	50
M25x1.5	16.0x4.0	19.0x7.0	30	28	7	1300.25.190.070	25
M32x1.5	19.0x3.0	22.0x6.0	36	28	8	1300.32.220.060	25
M32x1.5	19.0x5.0	22.0x8.0	36	28	8	1300.32.220.080	25
M40x1.5	23.0x4.0	26.0x7.0	46	31	8	1300.40.260.070	10
M40x1.5	23.5x6.0	26.5x9.0	46	31	8	1300.40.265.090	10
M40x1.5	25.0x3.0	28.0x6.0	46	31	8	1300.40.280.060	10
M40x1.5	27.0x7.0	30.0x10.0	46	31	8	1300.40.300.100	10
M40x1.5	29.0x6.0	32.0x9.0	46	31	8	1300.40.320.090	10
M40x1.5	30.0x3.5	33.0x6.5	46	31	8	1300.40.330.065	10
M50x1.5	31.0x8.5	34.0x11.5	55	34	9	1300.50.340.115	10
M50x1.5	34.0x4.0	37.0x7.0	55	34	9	1300.50.370.070	10
M50x1.5	36.5x2.5	40.0x6.0	55	34	9	1300.50.400.060	10
M50x1.5	36.5x10.0	40.0x13.5	55	34	9	1300.50.400.135	10
M50x1.5	38.5x10.5	42.0x14.0	55	34	9	1300.50.420.140	10
M63x1.5	42.0x10.0	46.0x14.0	70	37	10	1300.63.460.140	5
M63x1.5	42.5x2.0	46.5x6.0	70	37	10	1300.63.465.060	5

Erhältlich mit Dichteinsatz gemäss EN 45545 / NFPA 130.
 Bei Anfragen oder Bestellung bitte ein F vor die Artikelnummer setzen.

Available with sealing inserts conformity with EN 45545 / NFPA 130. When placing an inquiry, prefix the article number by the capital F.

Kabelverschraubungen Progress® Messing für Flachkabel Cable glands Progress® nickel-plated brass for flat cables

Langes Anschlussgewinde metrisch | Long entry thread metric

Material: Messing vernickelt
Dichtung: TPE
O-Ring: NBR
Zugentlastung: Ausführung A nach EN 62444
Schutzart: IP 68
Einsatztemperatur: -40 °C / +100 °C

Material: Nickel-plated brass
Seal: TPE
O-ring: NBR
Strain relief: Version A acc. to EN 62444
Protection class: IP 68
Operation temperature: -40 °C / +100 °C

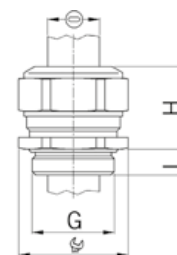

Progress MS FK



Einteiliger Dichteinsatz
nicht durchgehend isolierend

One-piece sealing insert
not overall length insulated

G	min mm	max mm	mm	H mm	L mm	Art.-No.	
M16x1.5	7.3x2.5	9.0x4.2	18	22	10	1301.17.090.042	50
M20x1.5	10.5x2.5	13.0x5.0	24	23	10	1301.20.130.050	50
M20x1.5	12.5x2.5	15.0x5.0	24	23	10	1301.20.150.050	50
M25x1.5	16.0x4.0	19.0x7.0	30	28	11	1301.25.190.070	25
M32x1.5	19.0x3.0	22.0x6.0	36	28	13	1301.32.220.060	25
M32x1.5	19.0x5.0	22.0x8.0	36	28	13	1301.32.220.080	25
M40x1.5	23.0x4.0	26.0x7.0	46	31	13	1301.40.260.070	10
M40x1.5	23.5x6.0	26.5x9.0	46	31	13	1301.40.265.090	10
M40x1.5	25.0x3.0	28.0x6.0	46	31	13	1301.40.280.060	10
M40x1.5	27.0x7.0	30.0x10.0	46	31	13	1301.40.300.100	10
M40x1.5	29.0x6.0	32.0x9.0	46	31	13	1301.40.320.090	10
M40x1.5	30.0x3.5	33.0x6.5	46	31	13	1301.40.330.065	10
M50x1.5	31.0x8.5	34.0x11.5	55	34	14	1301.50.340.115	10
M50x1.5	34.0x4.0	37.0x7.0	55	34	14	1301.50.370.070	10
M50x1.5	36.5x2.5	40.0x6.0	55	34	14	1301.50.400.060	10
M50x1.5	36.5x10.0	40.0x13.5	55	34	14	1301.50.400.135	10
M50x1.5	38.5x10.5	42.0x14.0	55	34	14	1301.50.420.140	10
M63x1.5	42.0x10.0	46.0x14.0	70	37	14	1301.63.460.140	5
M63x1.5	42.5x2.0	46.5x6.0	70	37	14	1301.63.465.060	5

Erhältlich mit Dichteinsatz gemäss EN 45545 / NFPA 130.
Bei Anfragen oder Bestellung bitte ein F vor die Artikelnummer setzen.

Available with sealing inserts conformity with EN 45545 / NFPA 130. When placing an inquiry, prefix the article number by the capital F.

Kabelverschraubungen Progress® Messing für Flachkabel

Cable glands Progress® nickel-plated brass for flat cables

Kurzes Anschlussgewinde Pg | Short entry thread Pg

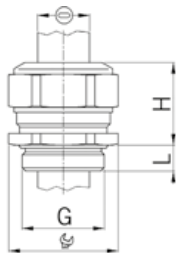

Material: Messing vernickelt
 Dichtung: TPE
 O-Ring: NBR
 Schutzart: IP 68
 Einsatztemperatur: -40 °C / +100 °C

Material: Nickel-plated brass
 Seal: TPE
 O-ring: NBR
 Protection class: IP 68
 Operation temperature: -40 °C / +100 °C



Einteiliger Dichteinsatz
 nicht durchgehend isolierend

One-piece sealing insert
 not overall length insulated

G	min mm	max mm	mm	H mm	L mm	Art.-No.	
Pg 9	7.3x2.5	9.0x4.2	18	22	6.0	1300.09.090.042	50
Pg 13	10.5x2.5	13.0x5.0	24	23	6.0	1300.13.130.050	50
Pg 13	12.5x2.5	15.0x5.0	24	23	6.0	1300.13.150.050	50
Pg 16	10.5x2.5	13.0x5.0	24	23	6.0	1300.16.130.050	50
Pg 16	12.5x2.5	15.0x5.0	24	23	6.0	1300.16.150.050	50
Pg 21	16.0x4.0	19.0x7.0	30	28	7.5	1300.21.190.070	25
Pg 21	19.0x3.0	22.0x6.0	36	28	7.5	1300.21.220.060	25
Pg 21	19.0x5.0	22.0x8.0	36	28	7.5	1300.21.220.080	25
Pg 29	23.0x4.0	26.0x7.0	46	31	8.0	1300.29.260.070	25
Pg 29	23.5x6.0	26.5x9.0	46	31	8.0	1300.29.265.090	25
Pg 29	25.0x3.0	28.0x6.0	46	31	8.0	1300.29.280.060	25
Pg 29	27.0x7.0	30.0x10.0	46	31	8.0	1300.29.300.100	25
Pg 29	29.0x6.0	32.0x9.0	46	31	8.0	1300.29.320.090	25
Pg 29	30.0x3.5	33.0x6.5	46	31	8.0	1300.29.330.065	25
Pg 42	31.0x8.5	34.0x11.5	55	34	10.0	1300.42.340.115	10
Pg 42	34.0x4.0	37.0x7.0	55	34	10.0	1300.42.370.070	10
Pg 42	36.5x2.5	40.0x6.0	55	34	10.0	1300.42.400.060	10
Pg 42	36.5x10.0	40.0x13.5	55	34	10.0	1300.42.400.135	10
Pg 42	38.5x10.5	42.0x14.0	55	34	10.0	1300.42.420.140	10
Pg 48	42.0x10.0	46.0x14.0	65	37	11.0	1300.48.460.140	10
Pg 48	42.5x2.0	46.5x6.0	65	37	11.0	1300.48.465.060	10

Langes Anschlussgewinde Pg | Long entry thread Pg



Einteiliger Dichteinsatz
 nicht durchgehend isolierend

One-piece sealing insert
 not overall length insulated

G	min mm	max mm	mm	H mm	L mm	Art.-No.	
Pg 9	7.3x2.5	9.0x4.2	18	22	10	1301.09.090.042	50
Pg 13	10.5x2.5	13.0x5.0	24	23	10	1301.13.130.050	50
Pg 13	12.5x2.5	15.0x5.0	24	23	10	1301.13.150.050	50
Pg 16	10.5x2.5	13.0x5.0	24	23	10	1301.16.130.050	50
Pg 16	12.5x2.5	15.0x5.0	24	23	10	1301.16.150.050	50
Pg 21	16.0x4.0	19.0x7.0	30	28	12	1301.21.190.070	25
Pg 21	19.0x3.0	22.0x6.0	36	28	12	1301.21.220.060	25
Pg 21	19.0x5.0	22.0x8.0	36	28	12	1301.21.220.080	25
Pg 29	23.0x4.0	26.0x7.0	46	31	12	1301.29.260.070	25
Pg 29	23.5x6.0	26.5x9.0	46	31	12	1301.29.265.090	25
Pg 29	25.0x3.0	28.0x6.0	46	31	12	1301.29.280.060	25
Pg 29	27.0x7.0	30.0x10.0	46	31	12	1301.29.300.100	25
Pg 29	29.0x6.0	32.0x9.0	46	31	12	1301.29.320.090	25
Pg 29	30.0x3.5	33.0x6.5	46	31	12	1301.29.330.065	25
Pg 42	31.0x8.5	34.0x11.5	55	34	15	1301.42.340.115	10
Pg 42	34.0x4.0	37.0x7.0	55	34	15	1301.42.370.070	10
Pg 42	36.5x2.5	40.0x6.0	55	34	15	1301.42.400.060	10
Pg 42	36.5x10.0	40.0x13.5	55	34	15	1301.42.400.135	10
Pg 42	38.5x10.5	42.0x14.0	55	34	15	1301.42.420.140	10
Pg 48	42.0x10.0	46.0x14.0	65	37	15	1301.48.460.140	10
Pg 48	42.5x2.0	46.5x6.0	65	37	15	1301.48.465.060	10

Kabelverschraubungen Progress® Messing mit speziellem Anschlussgewinde

Cable glands Progress® nickel-plated brass with special entry thread

Speziell langes Anschlussgewinde metrisch | Extra-long entry thread metric

Material:	Messing vernickelt	Material:	Nickel-plated brass
Dichtung:	TPE	Seal:	TPE
O-Ring:	NBR	O-ring:	NBR
Zugentlastung:	Ausführung A nach EN 62444	Strain relief:	Version A acc. to EN 62444
Schutzart:	IP 68 (bis 10 bar) / IP 69	Protection class:	IP 68 (up to 10 bar) / IP 69
Einsatztemperatur:	-40 °C / +100 °C	Operation temperature:	-40 °C / +100 °C

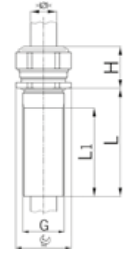

Zweiteiliger Dichteinsatz
nicht durchgehend isolierend

Two-piece sealing insert
not overall length insulated

G	> Ø <	> Ø <	> Ø <	> Ø <	⌀	H	L1	L	Art.-No.	
	min mm	max mm	min mm	max mm	mm	mm	mm	mm		
M16x1.5	6.0	8.0	8.0	10.5	24/18	22	40	50	1100.17.50	10
M16x1.5	6.0	8.0	8.0	10.5	24/18	22	60	100	1100.17.51	10
M20x1.5	8.0	11.0	11.0	15.0	30/24	23	40	50	1100.20.50	10
M20x1.5	8.0	11.0	11.0	15.0	30/24	23	60	100	1100.20.51	10
M25x1.5	12.5	16.0	16.0	20.5	36/30	28	40	50	1100.25.50	10
M25x1.5	12.5	16.0	16.0	20.5	36/30	28	60	100	1100.25.51	10
M32x1.5	17.0	21.0	21.0	25.5	46/36	28	40	50	1100.32.50	10
M32x1.5	17.0	21.0	21.0	25.5	46/36	28	60	100	1100.32.51	10
M40x1.5	24.0	28.5	28.5	33.0	55/46	31	40	50	1100.40.50	10



Progress MS L



Weitere Abmessungen auf Anfrage

Further dimensions upon request

Speziell langes Anschlussgewinde Pg | Specially long entry thread Pg

Material:	Messing vernickelt	Material:	Nickel-plated brass
Dichtung:	TPE	Seal:	TPE
O-Ring:	NBR	O-ring:	NBR
Schutzart:	IP 68 (bis 10 bar) / IP 69	Protection class:	IP 68 (up to 10 bar) / IP 69
Einsatztemperatur:	-40 °C / +100 °C	Operation temperature:	-40 °C / +100 °C

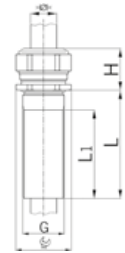

Zweiteiliger Dichteinsatz
nicht durchgehend isolierend

Two-piece sealing insert
not overall length insulated

G	> Ø <	> Ø <	> Ø <	> Ø <	⌀	H	L1	L	Art.-No.	
	min mm	max mm	min mm	max mm	mm	mm	mm	mm		
Pg 11	5.5	8.5	8.5	12.0	27/21	21	40	50	1100.11.50	10
Pg 13	8.0	11.0	11.0	15.0	30/24	23	40	50	1100.13.50	10
Pg 16	8.0	11.0	11.0	15.0	30/24	23	40	50	1100.16.50	10
Pg 21	12.5	16.0	16.0	20.5	38/30	28	40	50	1100.21.50	10
Pg 29	19.0	23.0	23.0	27.5	46/38	28	40	50	1100.29.50	10



Weitere Abmessungen auf Anfrage

Further dimensions upon request

Kabelverschraubungen Progress® Messing mit speziellem Anschlussgewinde

Cable glands Progress® nickel-plated brass with special entry thread

Mit Innengewinde metrisch | With inner thread metric

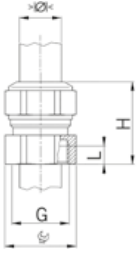

Material: Messing vernickelt
 Dichtung: TPE
 Zugentlastung: Ausführung A nach EN 62444
 Schutzart: IP 68, wenn Anschlussgewinde abgedichtet
 Einsatztemperatur: -40 °C / +100 °C

Material: Nickel-plated brass
 Seal: TPE
 Strain relief: Version A acc. to EN 62444
 Protection class: IP 68, if the entry thread is sealed
 Operation temperature: -40 °C / +100 °C



Zweiteiliger Dichteinsatz
 nicht durchgehend isolierend

Two-piece sealing insert
 not overall length insulated

G	>Ø< min mm	>Ø< max mm	>Ø< min mm	>Ø< max mm	H mm	L mm	Art.-No.	
M16x1.5	6.0	8.0	8.0	10.5	18	28	1400.17	25
M20x1.5	8.0	11.0	11.0	15.0	24	31	1400.20	25
M25x1.5	12.5	16.0	16.0	20.5	30	40	1400.25	25

Erhältlich mit Dichteinsatz gemäss EN 45545 / NFPA 130.
 Bei Anfragen oder Bestellung bitte ein F vor die Artikelnummer setzen.

Available with sealing inserts conformity with EN 45545 / NFPA 130. When placing an inquiry, prefix the article number by the capital F.

Mit Innengewinde Pg | With inner thread Pg

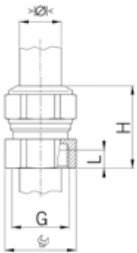

Material: Messing vernickelt
 Dichtung: TPE
 Schutzart: IP 68, wenn Anschlussgewinde abgedichtet
 Einsatztemperatur: -40 °C / +100 °C

Material: Nickel-plated brass
 Seal: TPE
 Protection class: IP 68, if the entry thread is sealed
 Operation temperature: -40 °C / +100 °C



Zweiteiliger Dichteinsatz
 nicht durchgehend isolierend

Two-piece sealing insert
 not overall length insulated

G	>Ø< min mm	>Ø< max mm	>Ø< min mm	>Ø< max mm	H mm	L mm	Art.-No.	
Pg 11	5.5	8.5	8.5	12.0	21	28	1400.11	25
Pg 16	8.0	11.0	11.0	15.0	24	31	1400.16	25
Pg 21	12.5	16.0	16.0	20.5	30	40	1400.21	25

Erhältlich mit Dichteinsatz gemäss EN 45545 / NFPA 130.
 Bei Anfragen oder Bestellung bitte ein F vor die Artikelnummer setzen.

Available with sealing inserts conformity with EN 45545 / NFPA 130. When placing an inquiry, prefix the article number by the capital F.

Kabelverschraubungen Progress® Messing mit Knickschutztülle EPDM Cable glands Progress® nickel-plated brass with antikink nozzle EPDM

Kurzes Anschlussgewinde metrisch | Short entry thread metric

Material: Messing vernickelt
Dichtung: NBR
O-Ring: NBR
Knickschutztülle: EPDM
Zugentlastung: Ausführung A nach EN 62444
Schutzart: IP 68 / IP 69
Einsatztemperatur: -40 °C / +100 °C

Material: Nickel-plated brass
Seal: NBR
O-ring: NBR
antikink nozzle: EPDM
Strain relief: Version A acc. to EN 62444
Protection class: IP 68 / IP 69
Operation temperature: -40 °C / +100 °C

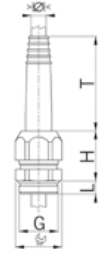

Einteiliger Dichteinsatz
nicht durchgehend isolierend

One-piece sealing insert
not overall length insulated

G	> Ø <	> Ø <	mm	H	T	L	i	Art.-No.	
	min mm	max mm	mm	mm	mm	mm	info		
M8x1.25	3.8	4.8	11	12	25	6	1	1008.52	50
M10x1.5	4.0	6.0	16	20	35	6	1	1010.52	50
M12x1.5	4.0	6.0	16	20	35	6	-	1012.52	50
M16x1.5	6.0	8.8	20	24	45	6	-	1017.52	50
M20x1.5	9.0	11.0	24	28	65	6	-	1020.51	25
M20x1.5	10.5	13.0	24	28	73	6	-	1020.52	25
M25x1.5	13.0	16.5	32	33	92	7	-	1025.52	10

1 = Metrisches Regelgewinde (mit VDE Testreport)

1 = Metric coarse-pitch thread (with VDE test report)



Kurzes Anschlussgewinde Pg | Short entry thread Pg

Material: Messing vernickelt
Dichtung: NBR
O-Ring: NBR
Knickschutztülle: EPDM
Schutzart: IP 68 / IP 69
Einsatztemperatur: -40 °C / +100 °C

Material: Nickel-plated brass
Seal: NBR
O-ring: NBR
antikink nozzle: EPDM
Protection class: IP 68 / IP 69
Operation temperature: -40 °C / +100 °C

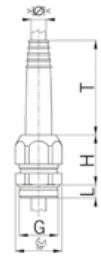

Einteiliger Dichteinsatz
nicht durchgehend isolierend

One-piece sealing insert
not overall length insulated

G	> Ø <	> Ø <	mm	H	T	L	Art.-No.	
	min mm	max mm	mm	mm	mm	mm		
Pg 7	4.0	6.0	16	20	35	6	1007.52	50
Pg 9	6.0	8.8	20	24	45	6	1009.52	50
Pg 11	6.0	8.8	20	24	45	6	1011.52	50
Pg 13	9.0	11.0	24	28	65	6	1013.51	25
Pg 13	10.5	13.0	24	28	73	6	1013.52	25
Pg 16	9.0	11.0	24	28	65	6	1016.51	25
Pg 16	10.5	13.0	24	28	73	6	1016.52	25
Pg 21	13.0	16.5	32	33	92	7.5	1021.51	10



Kabelverschraubungen Progress® Messing mit Knickschutzfeder

Cable glands Progress® nickel-plated brass with antikink spring

Kurzes Anschlussgewinde metrisch | Short entry thread metric

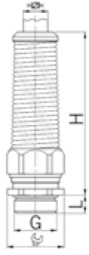

Material: Messing vernickelt
 Knickschutzfeder: Rostfreier Stahl A2
 Dichtung: TPE
 O-Ring: NBR
 Zugentlastung: Ausführung A nach EN 62444
 Schutzart: IP 68 (bis 10 bar) / IP 69
 Einsatztemperatur: -40 °C / +100 °C

Material: Nickel-plated brass
 Antikink spring: Stainless steel A2
 Seal: TPE
 O-ring: NBR
 Strain relief: Version A acc. to EN 62444
 Protection class: IP 68 (up to 10 bar) / IP 69
 Operation temperature: -40 °C / +100 °C



Progress MS FKN



Einteiliger Dichteinsatz
 durchgehend isolierend

One-piece sealing insert
 overall length insulated

G	>Ø< min mm	>Ø< max mm	mm	H mm	L mm	i info	Art.-No.	
M8x1.25	2.5	3.0	11	49	5	1	1060.08.52.030	10
M8x1.25	3.5	4.0	11	49	5	1	1060.08.52.040	10
M10x1.5	3.0	4.0	13	52	5	1	1060.10.52.040	10
M10x1.5	4.0	6.0	13	52	5	1	1060.10.52.060	10
M12x1.5	3.5	5.0	15	57	5	-	1060.12.52.050	10
M12x1.5	5.0	6.5	15	57	5	-	1060.12.52.065	10
M12x1.5	6.5	7.5	15	57	5	-	1060.12.52.075	10
M16x1.5	4.5	6.0	18	66	5	-	1060.17.52.060	10
M16x1.5	6.0	8.0	18	66	5	-	1060.17.52.080	10
M16x1.5	8.0	10.5	18	66	5	-	1060.17.52.105	10
M20x1.5	6.0	8.0	24	86	6	-	1060.20.52.080	10
M20x1.5	8.0	11.0	24	86	6	-	1060.20.52.110	10
M20x1.5	11.0	14.5	24	86	6	-	1060.20.52.145	10
M25x1.5	9.5	12.5	30	99	7	-	1060.25.52.125	10
M25x1.5	12.5	16.0	30	99	7	-	1060.25.52.160	10
M25x1.5	16.0	19.0	30	99	7	-	1060.25.52.190	10
M32x1.5	17.0	21.0	36	109	8	-	1060.32.52.210	5
M32x1.5	21.0	24.5	36	109	8	-	1060.32.52.245	5

1 = Metrisches Regelgewinde (mit VDE Testreport)
 Erhältlich mit Dichteinsatz gemäss EN 45545 / NFPA 130.
 Bei Anfragen oder Bestellung bitte ein F vor die Artikelnummer setzen.
 Auf Anfrage lieferbar:
 - Kurzes Anschlussgewinde mit kurzem ein- oder zweiteiligem Dichteinsatz.
 - Langes Anschlussgewinde mit kurzem oder durchgehend isolierendem ein- oder zweiteiligem Dichteinsatz.

1 = Metric coarse-pitch thread (with VDE test report)
 Available with sealing inserts conformity with EN 45545 / NFPA 130. When placing an inquiry, prefix the article number by the capital F.
 Available on request:
 - Short entry thread with short one-piece or two-piece sealing insert.
 - Long entry thread with short or full-length insulating one-piece or two-piece sealing insert.



Progress MS FKN



Zweiteiliger Dichteinsatz
 durchgehend isolierend

Two-piece sealing insert
 overall length insulated

G	>Ø< min mm	>Ø< max mm	>Ø< min mm	>Ø< max mm	mm	H mm	L mm	Art.-No.	
M16x1.5	6.0	8.0	8.0	10.5	18	66	5	1060.17.52	10
M20x1.5	8.0	11.0	11.0	14.5	24	86	6	1060.20.52	10
M25x1.5	12.5	16.0	16.0	19.0	30	99	7	1060.25.52	10
M32x1.5	17.0	20.0	20.0	24.5	36	109	8	1060.32.52	5

Erhältlich mit Dichteinsatz gemäss EN 45545 / NFPA 130.
 Bei Anfragen oder Bestellung bitte ein F vor die Artikelnummer setzen.
 Auf Anfrage lieferbar:
 - Kurzes Anschlussgewinde mit kurzem ein- oder zweiteiligem Dichteinsatz.
 - Langes Anschlussgewinde mit kurzem oder durchgehend isolierendem ein- oder zweiteiligem Dichteinsatz.

Available with sealing inserts conformity with EN 45545 / NFPA 130. When placing an inquiry, prefix the article number by the capital F.
 Available on request:
 - Short entry thread with short one-piece or two-piece sealing insert.
 - Long entry thread with short or full-length insulating one-piece or two-piece sealing insert.

Kabelverschraubungen Progress® Messing mit Knickschutzfeder Cable glands Progress® nickel-plated brass with antikink spring

Kurzes Anschlussgewinde Pg | Short entry thread Pg

Material: Messing vernickelt
Knickschutzfeder: Rostfreier Stahl A2
Dichtung: TPE
O-Ring: NBR
Schutzart: IP 68 (bis 10 bar) / IP 69
Einsatztemperatur: -40 °C / +100 °C

Material: Nickel-plated brass
Antikink spring: Stainless steel A2
Seal: TPE
O-ring: NBR
Protection class: IP 68 (up to 10 bar) / IP 69
Operation temperature: -40 °C / +100 °C

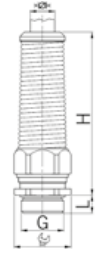

Einteiliger Dichteinsatz durchgehend isolierend

One-piece sealing insert overall length insulated

G	> < <	> < <	mm	H	L	Art.-No.	
	min mm	max mm	mm	mm	mm		
Pg 7	3.5	5.0	15	57	6	1060.07.52.050	10
Pg 7	5.0	6.5	15	57	6	1060.07.52.065	10
Pg 7	6.5	7.5	15	57	6	1060.07.52.075	10
Pg 9	4.5	6.0	18	66	6	1060.09.52.060	10
Pg 9	6.0	8.0	18	66	6	1060.09.52.080	10
Pg 9	8.0	10.5	18	66	6	1060.09.52.105	10
Pg 11	4.5	6.0	18/21	66	6	1060.11.52.060	10
Pg 11	6.0	8.0	18/21	66	6	1060.11.52.080	10
Pg 11	8.0	10.5	18/21	66	6	1060.11.52.105	10
Pg 13	6.0	8.0	24	86	6	1060.13.52.080	10
Pg 13	8.0	11.0	24	86	6	1060.13.52.110	10
Pg 13	11.0	14.5	24	86	6	1060.13.52.145	10
Pg 16	6.0	8.0	24	86	6	1060.16.52.080	10
Pg 16	8.0	11.0	24	86	6	1060.16.52.110	10
Pg 16	11.0	14.5	24	86	6	1060.16.52.145	10
Pg 21	9.5	12.5	30	99	7.5	1060.21.52.125	5
Pg 21	12.5	16.0	30	99	7.5	1060.21.52.160	5
Pg 21	16.0	19.0	30	99	7.5	1060.21.52.190	5

Erhältlich mit Dichteinsatz gemäss EN 45545 / NFPA 130. Bei Anfragen oder Bestellung bitte ein F vor die Artikelnummer setzen.

Available with sealing inserts conformity with EN 45545 / NFPA 130. When placing an inquiry, prefix the article number by the capital F.

Auf Anfrage lieferbar:

Available on request:

- Kurzes Anschlussgewinde mit kurzem ein- oder zweiteiligem Dichteinsatz.

- Short entry thread with short one-piece or two-piece sealing insert.

- Langes Anschlussgewinde mit kurzem oder durchgehend isolierendem ein- oder zweiteiligem Dichteinsatz.

- Long entry thread with short or full-length insulating one-piece or two-piece sealing insert.

Zweiteiliger Dichteinsatz durchgehend isolierend

Two-piece sealing insert overall length insulated

G	> < <	> < <	> < <	> < <	mm	H	L	Art.-No.	
	min mm	max mm	min mm	max mm	mm	mm	mm		
Pg 9	6.0	8.0	8.0	10.5	18	66	6	1060.09.52	10
Pg 11	6.0	8.0	8.0	10.5	18/21	66	6	1060.11.52	10
Pg 13	8.0	11.0	11.0	14.5	24	86	6	1060.13.52	10
Pg 16	8.0	11.0	11.0	14.5	24	86	6	1060.16.52	10
Pg 21	12.5	16.0	16.0	19.0	30	99	7.5	1060.21.52	5

Erhältlich mit Dichteinsatz gemäss EN 45545 / NFPA 130. Bei Anfragen oder Bestellung bitte ein F vor die Artikelnummer setzen.

Available with sealing inserts conformity with EN 45545 / NFPA 130. When placing an inquiry, prefix the article number by the capital F.

Auf Anfrage lieferbar:

Available on request:

- Kurzes Anschlussgewinde mit kurzem ein- oder zweiteiligem Dichteinsatz.

- Short entry thread with short one-piece or two-piece sealing insert.

- Langes Anschlussgewinde mit kurzem oder durchgehend isolierendem ein- oder zweiteiligem Dichteinsatz.

- Long entry thread with short or full-length insulating one-piece or two-piece sealing insert.



Kabelverschraubungen Progress® Messing mit Klemmbacken

Cable glands Progress® nickel-plated brass with clamps

Kurzes Anschlussgewinde metrisch | Short entry thread metric

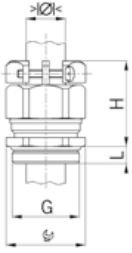

Material: Messing vernickelt
 Klemmschrauben: Rostfreier Stahl A2
 Dichtung: TPE
 O-Ring: NBR
 Zugentlastung: Ausführung B nach EN 62444
 Schutzart: IP 68 (bis 10 bar) / IP 69
 Einsatztemperatur: -40 °C / +100 °C

Material: Nickel-plated brass
 Screws: Stainless steel A2
 Seal: TPE
 O-ring: NBR
 Strain relief: Version B acc. to EN 62444
 Protection class: IP 68 (up to 10 bar) / IP 69
 Operation temperature: -40 °C / +100 °C



Einteiliger Dichteinsatz
 nicht durchgehend isolierend

One-piece sealing insert
 not overall length insulated

G	$\begin{matrix} > \ominus < \\ \text{min mm} & \text{max mm} \end{matrix}$	$\begin{matrix} > \ominus < \\ \text{min mm} & \text{max mm} \end{matrix}$	$\begin{matrix} \text{mm} \\ \text{mm} \end{matrix}$	$\begin{matrix} \text{mm} \\ \text{mm} \end{matrix}$	$\begin{matrix} \text{mm} \\ \text{mm} \end{matrix}$	i	Art.-No.	
M10x1.5	3.0	4.0	13/16	24	5	1	1800.10.03.040	50
M10x1.5	4.0	6.0	13/16	24	5	1	1800.10.03.060	50
M12x1.5	5.0	6.5	15/16	26	5	-	1800.12.03.065	50
M12x1.5	6.5	8.0	15/16	26	5	-	1800.12.03.080	50

1 = Metrisches Regelgewinde (mit VDE Testreport)

1 = Metric coarse-pitch thread (with VDE test report)

Erhältlich mit Dichteinsatz gemäss EN 45545 / NFPA 130. Bei Anfragen oder Bestellung bitte ein F vor die Artikelnummer setzen.

Available with sealing inserts conformity with EN 45545 / NFPA 130. When placing an inquiry, prefix the article number by the capital F.

Progress MS KB



Zweiteiliger Dichteinsatz
 nicht durchgehend isolierend

Two-piece sealing insert
 not overall length insulated

G	$\begin{matrix} > \ominus < \\ \text{min mm} & \text{max mm} \end{matrix}$	$\begin{matrix} > \ominus < \\ \text{min mm} & \text{max mm} \end{matrix}$	$\begin{matrix} > \ominus < \\ \text{min mm} & \text{max mm} \end{matrix}$	$\begin{matrix} > \ominus < \\ \text{min mm} & \text{max mm} \end{matrix}$	$\begin{matrix} \text{mm} \\ \text{mm} \end{matrix}$	H	L	Art.-No.	
M16x1.5	6.0	8.0	8.0	10.5	18/19	30	5	1800.17.03.105	50
M20x1.5	8.0	11.0	11.0	15.0	24	31	6	1800.20.03.150	50
M25x1.5	12.5	16.0	16.0	20.5	30	35	7	1800.25.03.205	25
M32x1.5	17.0	21.0	21.0	25.5	36	40	8	1800.32.03.255	25
M40x1.5	24.0	28.5	28.5	33.0	46	44	8	1800.40.03.330	10
M50x1.5	33.0	37.0	37.0	42.0	55	49	9	1800.50.03.410	10
M63x1.5	40.0	46.0	46.0	52.0	70	55	10	1800.63.03.520	5
M75x1.5	50.0	56.0	56.0	63.0	80	56	11	1800.75.03.630	1

Erhältlich mit Dichteinsatz gemäss EN 45545 / NFPA 130. Bei Anfragen oder Bestellung bitte ein F vor die Artikelnummer setzen.

Available with sealing inserts conformity with EN 45545 / NFPA 130. When placing an inquiry, prefix the article number by the capital F.

Progress MS KB



Kabelverschraubungen Progress® Messing mit Klemmbacken

Cable glands Progress® nickel-plated brass with clamps

Langes Anschlussgewinde metrisch | Long entry thread metric

Material:	Messing vernickelt	Material:	Nickel-plated brass
Klemmschrauben:	Rostfreier Stahl A2	Screws:	Stainless steel A2
Dichtung:	TPE	Seal:	TPE
O-Ring:	NBR	O-ring:	NBR
Zugentlastung:	Ausführung B nach EN 62444	Strain relief:	Version B acc. to EN 62444
Schutzart:	IP 68 (bis 10 bar) / IP 69	Protection class:	IP 68 (up to 10 bar) / IP 69
Einsatztemperatur:	-40 °C / +100 °C	Operation temperature:	-40 °C / +100 °C

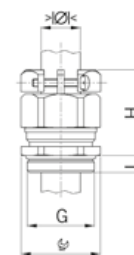

Einteiliger Dichteinsatz
nicht durchgehend isolierend

One-piece sealing insert
not overall length insulated

G	> Ø <	> Ø <	mm	H	L	i	Art.-No.	
	min mm	max mm	mm	mm	mm	info		
M10x1.5	3.0	4.0	13/16	24	10	1	1800.10.13.040	50
M10x1.5	4.0	6.0	13/16	24	10	1	1800.10.13.060	50
M12x1.5	5.0	6.5	15/16	26	10	-	1800.12.13.065	50
M12x1.5	6.5	8.0	15/16	26	10	-	1800.12.13.080	50

1 = Metrisches Regelgewinde (mit VDE Testreport)

1 = Metric coarse-pitch thread (with VDE test report)

Erhältlich mit Dichteinsatz gemäss EN 45545 / NFPA 130.
Bei Anfragen oder Bestellung bitte ein F vor die Artikelnummer setzen.

Available with sealing inserts conformity with EN 45545 / NFPA 130. When placing an inquiry, prefix the article number by the capital F.



Progress MS KB



Zweiteiliger Dichteinsatz
nicht durchgehend isolierend

Two-piece sealing insert
not overall length insulated

G	> Ø <	> Ø <	> Ø <	> Ø <	mm	H	L	Art.-No.	
	min mm	max mm	min mm	max mm	mm	mm	mm		
M16x1.5	6.0	8.0	8.0	10.5	18/19	30	10	1800.17.13.105	50
M20x1.5	8.0	11.0	11.0	15.0	24	31	10	1800.20.13.150	50
M25x1.5	12.5	16.0	16.0	20.5	30	35	11	1800.25.13.205	25
M32x1.5	17.0	21.0	21.0	25.5	36	40	13	1800.32.13.255	25
M40x1.5	24.0	28.5	28.5	33.0	46	44	13	1800.40.13.330	10
M50x1.5	33.0	37.0	37.0	42.0	55	49	14	1800.50.13.410	10
M63x1.5	40.0	46.0	46.0	52.0	70	55	14	1800.63.13.520	5
M75x1.5	50.0	56.0	56.0	63.0	80	56	15	1800.75.13.630	1

Erhältlich mit Dichteinsatz gemäss EN 45545 / NFPA 130.
Bei Anfragen oder Bestellung bitte ein F vor die Artikelnummer setzen.

Available with sealing inserts conformity with EN 45545 / NFPA 130. When placing an inquiry, prefix the article number by the capital F.



Progress MS KB



Kabelverschraubungen Progress® Messing mit Klemmbacken

Cable glands Progress® nickel-plated brass with clamps

Kurzes Anschlussgewinde Pg | Short entry thread Pg

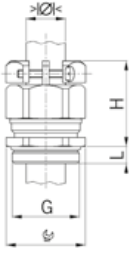

Material: Messing vernickelt
 Klemmschrauben: Rostfreier Stahl A2
 Dichtung: TPE
 O-Ring: NBR
 Schutzart: IP 68 (bis 10 bar) / IP 69
 Einsatztemperatur: -40 °C / +100 °C

Material: Nickel-plated brass
 Screws: Stainless steel A2
 Seal: TPE
 O-ring: NBR
 Protection class: IP 68 (up to 10 bar) / IP 69
 Operation temperature: -40 °C / +100 °C



Einteiliger Dichteinsatz
 nicht durchgehend isolierend

One-piece sealing insert
 not overall length insulated

G $\begin{matrix} >|O|< >|O|< \\ \text{min mm} & \text{max mm} \end{matrix}$ $\begin{matrix} \text{mm} \\ \text{mm} \end{matrix}$ **H** **L**
mm mm

Art.-No.



Pg 7	5.0	6.5	15/16	26	6	1800.07.03.065	50
Pg 7	6.5	8.0	15/16	26	6	1800.07.03.080	50

1800.07.03.065	50
1800.07.03.080	50

Erhältlich mit Dichteinsatz gemäss EN 45545 / NFPA 130.
 Bei Anfragen oder Bestellung bitte ein F vor die Artikelnummer setzen.

Available with sealing inserts conformity with EN 45545 / NFPA 130. When placing an inquiry, prefix the article number by the capital F.



Zweiteiliger Dichteinsatz
 nicht durchgehend isolierend

Two-piece sealing insert
 not overall length insulated

G $\begin{matrix} >|O|< >|O|< >|O|< >|O|< \\ \text{min mm} & \text{max mm} & \text{min mm} & \text{max mm} \end{matrix}$ $\begin{matrix} \text{mm} \\ \text{mm} \end{matrix}$ **H** **L**
mm mm mm mm

Art.-No.



Pg 9	6.0	8.0	8.0	10.5	18/19	30	6	1800.09.03.105	50
Pg 11	5.5	8.5	8.5	12.0	21	31	6	1800.11.03.120	50
Pg 13	8.0	11.0	11.0	15.0	24	31	6	1800.13.03.150	50
Pg 16	8.0	11.0	11.0	15.0	24	31	6	1800.16.03.150	50
Pg 21	12.5	16.0	16.0	20.5	30	35	7	1800.21.03.205	25
Pg 29	19.0	23.0	23.0	27.5	38	40	8	1800.29.03.275	25
Pg 36	26.0	30.5	30.5	35.0	50	47	8	1800.36.03.350	10
Pg 42	33.0	37.0	37.0	42.0	55	49	10	1800.42.03.410	10
Pg 48	37.0	43.0	43.0	49.0	65	51	11	1800.48.03.490	5

1800.09.03.105	50
1800.11.03.120	50
1800.13.03.150	50
1800.16.03.150	50
1800.21.03.205	25
1800.29.03.275	25
1800.36.03.350	10
1800.42.03.410	10
1800.48.03.490	5

Erhältlich mit Dichteinsatz gemäss EN 45545 / NFPA 130.
 Bei Anfragen oder Bestellung bitte ein F vor die Artikelnummer setzen.

Available with sealing inserts conformity with EN 45545 / NFPA 130. When placing an inquiry, prefix the article number by the capital F.

Kabelverschraubungen Progress® Messing mit Klemmbacken

Cable glands Progress® nickel-plated brass with clamps

Langes Anschlussgewinde Pg | Long entry thread Pg

Material: Messing vernickelt
 Klemmschrauben: Rostfreier Stahl A2
 Dichtung: TPE
 O-Ring: NBR
 Schutzart: IP 68 (bis 10 bar) / IP 69
 Einsatztemperatur: -40 °C / +100 °C

Material: Nickel-plated brass
 Screws: Stainless steel A2
 Seal: TPE
 O-ring: NBR
 Protection class: IP 68 (up to 10 bar) / IP 69
 Operation temperature: -40 °C / +100 °C

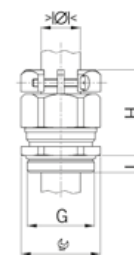

Einteiliger Dichteinsatz
 nicht durchgehend isolierend

One-piece sealing insert
 not overall length insulated

G $\begin{matrix} > \text{Ø} < \\ \text{min mm} & \text{max mm} \end{matrix}$ $\begin{matrix} > \text{Ø} < \\ \text{min mm} & \text{max mm} \end{matrix}$ $\begin{matrix} > \text{Ø} < \\ \text{min mm} & \text{max mm} \end{matrix}$ $\begin{matrix} > \text{Ø} < \\ \text{min mm} & \text{max mm} \end{matrix}$ $\begin{matrix} \text{Ø} \\ \text{mm} \end{matrix}$ **H** **L**
 mm mm

Pg 7 5.0 6.5 15/16 26 10

Pg 7 6.5 8.0 15/16 26 10

Art.-No.



1800.07.13.065

50

1800.07.13.080

50

Erhältlich mit Dichteinsatz gemäss EN 45545 / NFPA 130.
 Bei Anfragen oder Bestellung bitte ein F vor die Artikelnummer setzen.

Available with sealing inserts conformity with EN 45545 / NFPA 130. When placing an inquiry, prefix the article number by the capital F.



Zweiteiliger Dichteinsatz
 nicht durchgehend isolierend

Two-piece sealing insert
 not overall length insulated

G $\begin{matrix} > \text{Ø} < \\ \text{min mm} & \text{max mm} \end{matrix}$ $\begin{matrix} > \text{Ø} < \\ \text{min mm} & \text{max mm} \end{matrix}$ $\begin{matrix} > \text{Ø} < \\ \text{min mm} & \text{max mm} \end{matrix}$ $\begin{matrix} > \text{Ø} < \\ \text{min mm} & \text{max mm} \end{matrix}$ $\begin{matrix} \text{Ø} \\ \text{mm} \end{matrix}$ **H** **L**
 mm mm

Pg 9 6.0 8.0 8.0 10.5 18/19 30 10

Pg 11 5.5 8.5 8.5 12.0 21 31 10

Pg 13 8.0 11.0 11.0 15.0 24 31 10

Pg 16 8.0 11.0 11.0 15.0 24 31 10

Pg 21 12.5 16.0 16.0 20.5 30 35 12

Pg 29 19.0 23.0 23.0 27.5 38 40 12

Pg 36 26.0 30.5 30.5 35.0 50 47 15

Pg 42 33.0 37.0 37.0 42.0 55 49 15

Pg 48 37.0 43.0 43.0 49.0 65 51 15

Art.-No.



1800.09.13.105

50

1800.11.13.120

50

1800.13.13.150

50

1800.16.13.150

50

1800.21.13.205

25

1800.29.13.275

25

1800.36.13.350

10

1800.42.13.410

10

1800.48.13.490

5

Erhältlich mit Dichteinsatz gemäss EN 45545 / NFPA 130.
 Bei Anfragen oder Bestellung bitte ein F vor die Artikelnummer setzen.

Available with sealing inserts conformity with EN 45545 / NFPA 130. When placing an inquiry, prefix the article number by the capital F.



Klembacken-Stutzen Messing

Clamp jaw nozzle brass

Anschlussgewinde metrisch | Entry thread metric

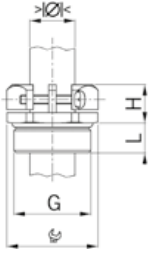

Material: Messing vernickelt
 Klemmschrauben: Rostfreier Stahl A2
 Zugentlastung: Ausführung B nach EN 62444
 Schutzart: IP 20
 Einsatztemperatur: -50 °C / +300 °C

Material: Nickel-plated brass
 Screws: Stainless steel A2
 Strain relief: Version B acc. to EN 62444
 Protection class: IP 20
 Operation temperature: -50 °C / +300 °C



Mechanische Zugentlastung B

Mechanical strain relief B

G	>Ø< min mm	>Ø< max mm	mm	H mm	L mm	Art.-No.	
M12x1.5	5.0	8.0	16	10	10	1812.02	50
M16x1.5	6.0	10.5	19	11	10	1817.02	50
M20x1.5	8.0	15.0	24	12	10	1820.02	50
M25x1.5	12.5	20.5	30	13	11	1825.02	25
M32x1.5	17.0	25.5	36	15	13	1832.02	25
M40x1.5	24.0	33.0	46	17	13	1840.02	10

Anschlussgewinde Pg | Entry thread Pg

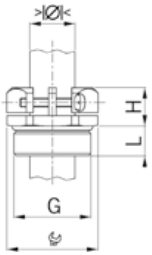

Material: Messing vernickelt
 Klemmschrauben: Rostfreier Stahl A2
 Schutzart: IP 20
 Einsatztemperatur: -50 °C / +300 °C

Material: Nickel-plated brass
 Screws: Stainless steel A2
 Protection class: IP 20
 Operation temperature: -50 °C / +300 °C



Mechanische Zugentlastung B

Mechanical strain relief B

G	>Ø< min mm	>Ø< max mm	mm	H mm	L mm	Art.-No.	
Pg 7	4.0	8.0	17	10	6	1807.02	50
Pg 9	6.0	10.0	20	11	6	1809.02	50
Pg 11	6.0	12.0	22	11	6	1811.02	50
Pg 13	7.0	15.0	24	11	7	1813.02	50
Pg 16	9.0	17.0	27	12	7	1816.02	50
Pg 21	12.0	22.0	35	14	8	1821.02	25
Pg 29	18.0	30.0	42	15	8	1829.02	25
Pg 36	24.0	36.0	55	18	10	1836.02	10

Kabelverschraubungen Progress® Messing mit Trompete

Cable glands Progress® nickel-plated brass with trumpet

Kurzes Anschlussgewinde metrisch | Short entry thread metric

Material: Messing vernickelt
 Dichtung: TPE
 O-Ring: NBR
 Zugentlastung: Ausführung A nach EN 62444
 Schutzart: IP 68 (bis 10 bar) / IP 69
 Einsatztemperatur: -40 °C / +100 °C

Material: Nickel-plated brass
 Seal: TPE
 O-ring: NBR
 Strain relief: Version A acc. to EN 62444
 Protection class: IP 68 (up to 10 bar) / IP 69
 Operation temperature: -40 °C / +100 °C

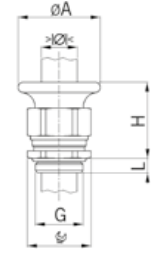

Zweiteiliger Dichteinsatz
 nicht durchgehend isolierend

Two-piece sealing insert
 not overall length insulated

G	Ø		Ø		mm	ØA	H	L	Art.-No.	mm
	min mm	max mm	min mm	max mm						
M16x1.5	6.0	8.0	8.0	10.5	18	28	31	5	1800.10.17	50
M20x1.5	8.0	11.0	11.0	15.0	24	34	32	6	1800.10.20	50
M25x1.5	12.5	16.0	16.0	20.5	30	44	38	7	1800.10.25	25
M32x1.5	17.0	21.0	21.0	25.5	36	50	44	8	1800.10.32	25
M40x1.5	24.0	28.5	28.5	33.0	46	57	46	8	1800.10.40	10

Erhältlich mit Dichteinsatz gemäss EN 45545 / NFPA 130.
 Bei Anfragen oder Bestellung bitte ein F vor die Artikelnummer setzen.

Available with sealing inserts conformity with EN 45545 / NFPA 130. When placing an inquiry, prefix the article number by the capital F.



Progress MS T



Langes Anschlussgewinde metrisch | Long entry thread metric

Zweiteiliger Dichteinsatz
 nicht durchgehend isolierend

Two-piece sealing insert
 not overall length insulated

G	Ø		Ø		mm	ØA	H	L	Art.-No.	mm
	min mm	max mm	min mm	max mm						
M16x1.5	6.0	8.0	8.0	10.5	18	28	31	10	1800.11.17	50
M20x1.5	8.0	11.0	11.0	15.0	24	34	32	10	1800.11.20	50
M25x1.5	12.5	16.0	16.0	20.5	30	44	38	11	1800.11.25	25
M32x1.5	17.0	21.0	21.0	25.5	36	50	44	13	1800.11.32	25
M40x1.5	24.0	28.5	28.5	33.0	46	57	46	13	1800.11.40	10

Erhältlich mit Dichteinsatz gemäss EN 45545 / NFPA 130.
 Bei Anfragen oder Bestellung bitte ein F vor die Artikelnummer setzen.

Available with sealing inserts conformity with EN 45545 / NFPA 130. When placing an inquiry, prefix the article number by the capital F.



Progress MS T



Kabelverschraubungen Progress® Messing mit Trompete

Cable glands Progress® nickel-plated brass with trumpet

Kurzes Anschlussgewinde Pg | Short entry thread Pg

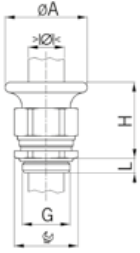

Material: Messing vernickelt
 Dichtung: TPE
 O-Ring: NBR
 Schutzart: IP 68 (bis 10 bar) / IP 69
 Einsatztemperatur: -40 °C / +100 °C

Material: Nickel-plated brass
 Seal: TPE
 O-ring: NBR
 Protection class: IP 68 (up to 10 bar) / IP 69
 Operation temperature: -40 °C / +100 °C



Zweiteiliger Dichteinsatz
 nicht durchgehend isolierend

Two-piece sealing insert
 not overall length insulated

G	\varnothing		\varnothing		\varnothing	$\varnothing A$	H	L	Art.-No.	
	min mm	max mm	min mm	max mm						
Pg 9	6.0	8.0	8.0	10.5	18	28	31	6	1800.10.09	50
Pg 11	5.5	8.5	8.5	12.0	21	30	31	6	1800.10.11	50
Pg 13	8.0	11.0	11.0	15.0	24	34	32	6	1800.10.13	50
Pg 16	8.0	11.0	11.0	15.0	24	34	32	6	1800.10.16	50
Pg 21	12.5	16.0	16.0	20.5	30	44	38	7.5	1800.10.21	25
Pg 29	19.0	23.0	23.0	27.5	38	50	44	8	1800.10.29	10

Erhältlich mit Dichteinsatz gemäss EN 45545 / NFPA 130.
 Bei Anfragen oder Bestellung bitte ein F vor die Artikelnummer setzen.

Available with sealing inserts conformity with EN 45545 / NFPA 130. When placing an inquiry, prefix the article number by the capital F.

Langes Anschlussgewinde Pg | Long entry thread Pg



Zweiteiliger Dichteinsatz
 nicht durchgehend isolierend

Two-piece sealing insert
 not overall length insulated

G	\varnothing		\varnothing		\varnothing	$\varnothing A$	H	L	Art.-No.	
	min mm	max mm	min mm	max mm						
Pg 9	6.0	8.0	8.0	10.5	18	28	31	10	1800.11.09	50
Pg 11	5.5	8.5	8.5	12.0	21	30	31	10	1800.11.11	50
Pg 13	8.0	11.0	11.0	15.0	24	34	32	10	1800.11.13	50
Pg 16	8.0	11.0	11.0	15.0	24	34	32	10	1800.11.16	50
Pg 21	12.5	16.0	16.0	20.5	30	44	38	12	1800.11.21	25
Pg 29	19.0	23.0	23.0	27.5	38	50	44	12	1800.11.29	10

Erhältlich mit Dichteinsatz gemäss EN 45545 / NFPA 130.
 Bei Anfragen oder Bestellung bitte ein F vor die Artikelnummer setzen.

Available with sealing inserts conformity with EN 45545 / NFPA 130. When placing an inquiry, prefix the article number by the capital F.

Kabelverschraubungen Progress® Messing mit Trompete und Klemmbacken

Cable glands Progress® nickel-plated brass with trumpet and clamps

Kurzes Anschlussgewinde metrisch | Short entry thread metric

Material: Messing vernickelt
 Klemmschrauben: Rostfreier Stahl A2
 Dichtung: TPE
 O-Ring: NBR
 Zugentlastung: Ausführung B nach EN 62444
 Schutzart: IP 68 (bis 10 bar) / IP 69
 Einsatztemperatur: -40 °C / +100 °C

Material: Nickel-plated brass
 Screws: Stainless steel A2
 Seal: TPE
 O-ring: NBR
 Strain relief: Version B acc. to EN 62444
 Protection class: IP 68 (up to 10 bar) / IP 69
 Operation temperature: -40 °C / +100 °C

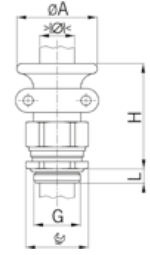

Zweiteiliger Dichteinsatz
 nicht durchgehend isolierend

Two-piece sealing insert
 not overall length insulated

G	>Ø< min mm	>Ø< max mm	>Ø< min mm	>Ø< max mm	mm	ØA mm	H mm	L mm	Art.-No.	
M16x1.5	6.0	8.0	8.0	10.5	18	28	43	5	1801.10.17	50
M20x1.5	8.0	11.0	11.0	15.0	24	34	46	6	1801.10.20	50
M25x1.5	12.5	16.0	16.0	20.5	30	44	52	7	1801.10.25	25
M32x1.5	17.0	21.0	21.0	25.5	36	50	59	8	1801.10.32	10
M40x1.5	24.0	28.5	28.5	33.0	46	57	59	8	1801.10.40	5

Erhältlich mit Dichteinsatz gemäss EN 45545 / NFPA 130.
 Bei Anfragen oder Bestellung bitte ein F vor die Artikelnummer setzen.

Available with sealing inserts conformity with EN 45545 / NFPA 130. When placing an inquiry, prefix the article number by the capital F.



Progress MS T+KB



Langes Anschlussgewinde metrisch | Long entry thread metric

Zweiteiliger Dichteinsatz
 nicht durchgehend isolierend

Two-piece sealing insert
 not overall length insulated

G	>Ø< min mm	>Ø< max mm	>Ø< min mm	>Ø< max mm	mm	ØA mm	H mm	L mm	Art.-No.	
M16x1.5	6.0	8.0	8.0	10.5	18	28	43	10	1801.11.17	50
M20x1.5	8.0	11.0	11.0	15.0	24	34	46	10	1801.11.20	50
M25x1.5	12.5	16.0	16.0	20.5	30	44	52	11	1801.11.25	25
M32x1.5	17.0	21.0	21.0	25.5	36	50	59	13	1801.11.32	10
M40x1.5	24.0	28.5	28.5	33.0	46	57	59	13	1801.11.40	5

Erhältlich mit Dichteinsatz gemäss EN 45545 / NFPA 130.
 Bei Anfragen oder Bestellung bitte ein F vor die Artikelnummer setzen.

Available with sealing inserts conformity with EN 45545 / NFPA 130. When placing an inquiry, prefix the article number by the capital F.



Progress MS T+KB



Kabelverschraubungen Progress® Messing mit Trompete und Klemmbacken

Cable glands Progress® nickel-plated brass with trumpet and clamps

Kurzes Anschlussgewinde Pg | Short entry thread Pg

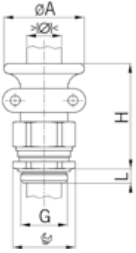

Material: Messing vernickelt
 Klemmschrauben: Rostfreier Stahl A2
 Dichtung: TPE
 O-Ring: NBR
 Schutzart: IP 68 (bis 10 bar) / IP 69
 Einsatztemperatur: -40 °C / +100 °C

Material: Nickel-plated brass
 Screws: Stainless steel A2
 Seal: TPE
 O-ring: NBR
 Protection class: IP 68 (up to 10 bar) / IP 69
 Operation temperature: -40 °C / +100 °C



Zweiteiliger Dichteinsatz
 nicht durchgehend isolierend

Two-piece sealing insert
 not overall length insulated

G	>Ø<		>Ø<		mm	ØA	H	L	Art.-No.	
	min mm	max mm	min mm	max mm						
Pg 9	6.0	8.0	8.0	10.5	18	28	43	6	1801.10.09	50
Pg 11	5.5	8.5	8.5	12.0	21	30	43	6	1801.10.11	50
Pg 13	8.0	11.0	11.0	15.0	24	34	46	6	1801.10.13	50
Pg 16	8.0	11.0	11.0	15.0	24	34	46	6	1801.10.16	50
Pg 21	12.5	16.0	16.0	20.5	30	44	52	7.5	1801.10.21	25
Pg 29	19.0	23.0	23.0	27.5	38	50	59	8	1801.10.29	10

Erhältlich mit Dichteinsatz gemäss EN 45545 / NFPA 130.
 Bei Anfragen oder Bestellung bitte ein F vor die Artikelnummer setzen.

Available with sealing inserts conformity with EN 45545 / NFPA 130. When placing an inquiry, prefix the article number by the capital F.

Langes Anschlussgewinde Pg | Long entry thread Pg



Zweiteiliger Dichteinsatz
 nicht durchgehend isolierend





Two-piece sealing insert
 not overall length insulated

G	>Ø<		>Ø<		mm	ØA	H	L	Art.-No.	
	min mm	max mm	min mm	max mm						
Pg 9	6.0	8.0	8.0	10.5	18	28	43	10	1801.11.09	50
Pg 11	5.5	8.5	8.5	12.0	21	30	43	10	1801.11.11	50
Pg 13	8.0	11.0	11.0	15.0	24	34	46	10	1801.11.13	50
Pg 16	8.0	11.0	11.0	15.0	24	34	46	10	1801.11.16	50
Pg 21	12.5	16.0	16.0	20.5	30	44	52	12	1801.11.21	25
Pg 29	19.0	23.0	23.0	27.5	38	50	59	12	1801.11.29	10

Erhältlich mit Dichteinsatz gemäss EN 45545 / NFPA 130.
 Bei Anfragen oder Bestellung bitte ein F vor die Artikelnummer setzen.

Available with sealing inserts conformity with EN 45545 / NFPA 130. When placing an inquiry, prefix the article number by the capital F.



Kabelverschraubungen Progress® rostfreier Stahl A2 Cable glands Progress® stainless steel A2		60 - 61
Kabelverschraubungen Progress® rostfreier Stahl A2 für hohe Temperaturen Cable glands Progress® stainless steel A2 for high temperature applications		62 - 63
Kabelverschraubungen Progress® rostfreier und säurebeständiger Stahl A4 für hohe Temperaturen Cable glands Progress® stainless and acid-resistant steel A4 for high temperature applications		64 - 65
Kabelverschraubungen Progress® aqua rostfreier Stahl A2 für Trinkwasser Cable glands Progress® aqua stainless steel A2 for drinking water		66

1

2

3

4

5

6

7

8

9

10

11

12

13

14

15

Kabelverschraubungen Progress® aus rostfreiem Stahl

Progress® cable glands of stainless steel

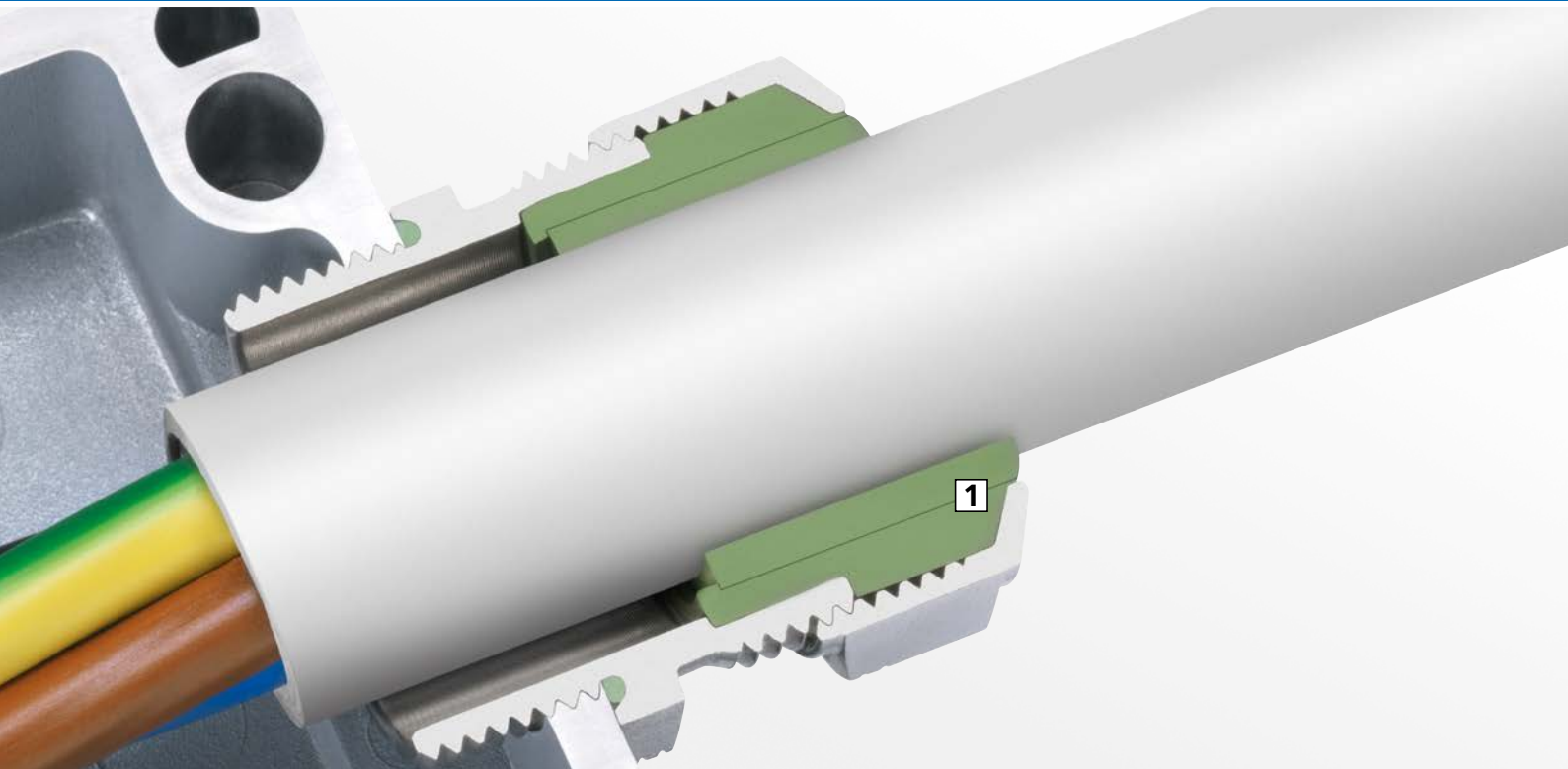

AGRO Kabelverschraubungen Progress® aus rostfreiem Stahl weisen eine hohe Korrosionsbeständigkeit und Langlebigkeit auf. Sie sind prädestiniert für den erschwerten Einsatz in der Lebensmittel sowie chemischen Industrie oder auch an Orten mit besonderen Umweltbedingungen wie z.B. in Tunneln oder auf hoher See. Rostfreie Stähle werden durch die zugeordnete Werkstoffnummer eindeutig spezifiziert. AGRO verwendet für die Kabelverschraubungen den rostfreien Stahl A2 mit der Werkstoffnummer 1.4305 (AISI 303) und für den rostfreien und säurebeständigen Stahl A4 den Werkstoff 1.4435 (AISI 316L).

1 Garantierte Dichtigkeit

Auf den Dichteinsatz abgestimmte Innenkonturen sorgen für eine zielgerichtete Verformung des Dichteinsatzes und garantieren somit dessen perfekte Abdichtung. Die Schutzart IP 68 bis 10 bar sowie IP 69 ermöglichen eine breite Anwendung.

AGRO's Progress® cable glands of stainless steel are highly corrosion-resistant and extremely durable. They are ideal for challenging applications in the food or chemical industries, or for demanding environmental conditions such as in tunnels or offshore locations.

Stainless steels are clearly specified by the allocated material number. For cable glands, AGRO uses stainless steel of type A2 with the material number 1.4305 (AISI 303), or of type A4 (acid-resistant) with the material number 1.4435 (AISI 316L).

1 Absolutely reliable sealing performance

Inner contours precisely matching the sealing insert ensure appropriate deformation of the sealing insert and thus excellent sealing performance. Protection classes IP 68 (up to 10 bar) and IP 69 make it suitable for a wide range of applications.

Kennzeichnung Stahltyp

Identification markings for steel type



1 Rille kennzeichnet **Stahl A2**.
Dichteinsatz in TPE (schwarz)

1 groove identifies **A2 steel**.
Here: Sealing insert of type TPE (black).



1 Rille kennzeichnet **Stahl A2**.
Dichteinsatz in FPM (grün) für hohe Temperaturen

1 groove identifies **A2 steel**.
Here: Sealing insert of type FPM (green) for high-temperature applications.

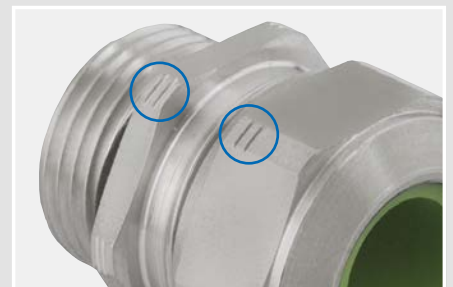

2 Rillen kennzeichnen **Stahl A4**.
Dichteinsatz in FPM für hohe Temperaturen und Säurebeständigkeit (grün)

2 grooves identify **A4 steel**.
Here: Sealing insert of type FPM (green) for high temperatures and resistance to acids.

	Progress® Serie Progress® series	Rostfreier Stahl A2 Stainless steel (A2)	Rostfreier Stahl A2 hohe Temperaturen Stainless steel (A2) high temperatures	Rostfreier & säure- beständiger Stahl A4 hohe Temperaturen Stainless and acid- resistant steel (A4), high temperatures	Progress® aqua rostfreier Stahl A2 für Trinkwasser Progress® aqua stainless steel (A2) for drinking water
Ausführung / Type					
Kompressionstechnik Compression technology		•	•	•	•
Gewinde / Thread					
Anschlussgewinde metrisch Metric entry thread		•	•	•	•
Anschlussgewinde Pg PG entry thread		•	•	•	-
Langes Anschlussgewinde Long entry thread		•	•	•	•
Kurzes Anschlussgewinde (Standard) Short entry thread (standard)		A	A	A	A
Dichteinsatz / Sealing insert					
Für Rundkabel For round cables		•	•	•	•
Für mehrere Kabel (Multi-Dichteinsatz) For multiple cables (Multi sealing insert)		A	A	A	A
Dichteinsatz ohne Bohrung Sealing insert without hole		A	A	A	-
Einteiliger Dichteinsatz One-piece sealing insert		•	•	•	•
Zweiteiliger Dichteinsatz Two-piece sealing insert		•	•	•	-
Dichteinsatz für EN 45545 Sealing insert for EN 45545		•	-	A	-
Dichteinsatz EPDM (SVGW zertifiziert) EPDM sealing insert (SVGW-certified)		-	-	-	•
Technische Besonderheiten / Technical characteristics					
Hohe Säurebeständigkeit Highly acid-resistant		-	-	•	-
Material / Material					
Rostfreier Stahl A2 Stainless steel of type A2		•	•	-	•
Rostfreier Stahl A4 Stainless steel of type A4		-	-	•	-

A = Auf Anfrage / A = upon request

Langes Anschlussgewinde metrisch | Long entry thread metric

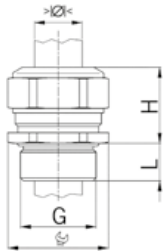

Material: Rostfreier CrNi-Stahl A2 (DIN EN 1.4305 / AISI 303)
 Kennzeichnung: 1 Rille
 Dichtung: TPE
 O-Ring: NBR
 Zugentlastung: Ausführung A nach EN 62444
 Schutzart: IP 68 (bis 10 bar) / IP 69
 Einsatztemperatur: -40 °C / +100 °C

Material: CrNi stainless steel A2 (DIN EN 1.4305 / AISI 303)
 Identification: 1 groove
 Seal: TPE
 O-ring: NBR
 Strain relief: Version A acc. to EN 62444
 Protection class: IP 68 (up to 10 bar) / IP 69
 Operation temperature: -40 °C / +100 °C



Einteiliger Dichteinsatz
nicht durchgehend isolierend

One-piece sealing insert
not overall length insulated

G	>Ø< min mm	>Ø< max mm	Ø mm	H mm	L mm	i info	Art.-No.	
M8x1.25	2.5	3.5	11	14	10	1	1100.08.94.035	50
M8x1.25	3.5	5.0	11	14	10	1	1100.08.94.050	50
M10x1.5	3.0	4.0	13	15	10	1	1100.10.94.040	50
M10x1.5	4.0	6.0	13	15	10	1	1100.10.94.060	50
M12x1.5	3.5	5.0	17	17	10	-	1100.12.94.050	50
M12x1.5	5.0	6.5	17	17	10	-	1100.12.94.065	50
M12x1.5	6.5	8.0	17	17	10	-	1100.12.94.080	50
M16x1.5	8.0	10.5	19	20	10	-	1100.17.94.105	50
M20x1.5	11.0	15.0	24	21	10	-	1100.20.94.150	50
M25x1.5	16.0	20.5	30	25	11	-	1100.25.94.205	25
M32x1.5	21.0	25.5	36	28	13	-	1100.32.94.255	25
M40x1.5	28.5	33.0	46	31	13	-	1100.40.94.330	10
M50x1.5	37.0	42.0	55	34	14	-	1100.50.94.420	10
M63x1.5	46.0	52.0	70	37	14	-	1100.63.94.520	5

1 = Metrisches Regelgewinde (mit VDE Testreport)

1 = Metric coarse-pitch thread (with VDE test report)

Erhältlich mit Dichteinsatz gemäss EN 45545 / NFPA 130.
Bei Anfragen oder Bestellung bitte ein F vor die Artikelnummer setzen.

Available with sealing inserts conformity with EN 45545 / NFPA 130. When placing an inquiry, prefix the article number by the capital F.



Zweiteiliger Dichteinsatz
nicht durchgehend isolierend

Two-piece sealing insert
not overall length insulated

G	>Ø< min mm	>Ø< max mm	>Ø< min mm	>Ø< max mm	Ø mm	H mm	L mm	Art.-No.	
M16x1.5	6.0	8.0	8.0	10.5	19	20	10	1100.17.94	50
M20x1.5	8.0	11.0	11.0	15.0	24	21	10	1100.20.94	50
M25x1.5	12.5	16.0	16.0	20.5	30	25	11	1100.25.94	25
M32x1.5	17.0	21.0	21.0	25.5	36	28	13	1100.32.94	25
M40x1.5	24.0	28.5	28.5	33.0	46	31	13	1100.40.94	10
M50x1.5	33.0	37.0	37.0	42.0	55	34	14	1100.50.94	10
M63x1.5	40.0	46.0	46.0	52.0	70	37	14	1100.63.94	5

Erhältlich mit Dichteinsatz gemäss EN 45545 / NFPA 130.
Bei Anfragen oder Bestellung bitte ein F vor die Artikelnummer setzen.

Available with sealing inserts conformity with EN 45545 / NFPA 130. When placing an inquiry, prefix the article number by the capital F.

Progress S2



Progress S2



Langes Anschlussgewinde Pg | Long entry thread Pg

Material: Rostfreier CrNi-Stahl A2 (DIN EN 1.4305 / AISI 303)
 Kennzeichnung: 1 Rille
 Dichtung: TPE
 O-Ring: NBR
 Schutzart: IP 68 (bis 10 bar) / IP 69
 Einsatztemperatur: -40 °C / +100 °C

Material: CrNi stainless steel A2 (DIN EN 1.4305 / AISI 303)
 Identification: 1 groove
 Seal: TPE
 O-ring: NBR
 Protection class: IP 68 (up to 10 bar) / IP 69
 Operation temperature: -40 °C / +100 °C

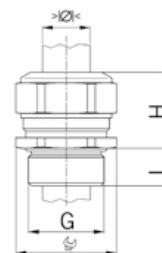

Einteiliger Dichteinsatz
 nicht durchgehend isolierend

One-piece sealing insert
 not overall length insulated

G	$\begin{matrix} >10< \\ \text{min mm} \end{matrix}$	$\begin{matrix} >10< \\ \text{max mm} \end{matrix}$	$\begin{matrix} >10< \\ \text{mm} \end{matrix}$	H	L	Art.-No.	
Pg 7	3.5	5.0	17	17	10	1100.07.94.050	50
Pg 7	5.0	6.5	17	17	10	1100.07.94.065	50
Pg 7	6.5	8.0	17	17	10	1100.07.94.080	50
Pg 9	8.0	10.5	19	20	10	1100.09.94.105	50
Pg 11	8.5	12.0	22	21	10	1100.11.94.120	50
Pg 13	11.0	15.0	24	21	10	1100.13.94.150	50
Pg 16	11.0	15.0	24	21	10	1100.16.94.150	50
Pg 21	16.0	20.5	30	25	12	1100.21.94.205	25
Pg 29	23.0	27.5	41	28	12	1100.29.94.275	25
Pg 36	30.5	35.0	50	32	15	1100.36.94.350	10
Pg 42	37.0	42.0	55	34	15	1100.42.94.420	10
Pg 48	43.0	49.0	65	37	15	1100.48.94.490	10

Erhältlich mit Dichteinsatz gemäss EN 45545 / NFPA 130. Bei Anfragen oder Bestellung bitte ein F vor die Artikelnummer setzen.

Available with sealing inserts conformity with EN 45545 / NFPA 130. When placing an inquiry, prefix the article number by the capital F.



Zweiteiliger Dichteinsatz
 nicht durchgehend isolierend

Two-piece sealing insert
 not overall length insulated

G	$\begin{matrix} >10< \\ \text{min mm} \end{matrix}$	$\begin{matrix} >10< \\ \text{max mm} \end{matrix}$	$\begin{matrix} >10< \\ \text{min mm} \end{matrix}$	$\begin{matrix} >10< \\ \text{max mm} \end{matrix}$	$\begin{matrix} >10< \\ \text{mm} \end{matrix}$	H	L	Art.-No.	
Pg 9	6.0	8.0	8.0	10.5	19	20	10	1100.09.94	50
Pg 11	5.5	8.5	8.5	12.0	21	21	10	1100.11.94	50
Pg 13	8.0	11.0	11.0	15.0	24	21	10	1100.13.94	50
Pg 16	8.0	11.0	11.0	15.0	24	21	10	1100.16.94	50
Pg 21	12.5	16.0	16.0	20.5	30	25	12	1100.21.94	25
Pg 29	19.0	23.0	23.0	27.5	41	28	12	1100.29.94	25
Pg 36	26.0	30.5	30.5	35.0	50	32	15	1100.36.94	10
Pg 42	33.0	37.0	37.0	42.0	55	34	15	1100.42.94	10
Pg 48	37.0	43.0	43.0	49.0	65	37	15	1100.48.94	10

Erhältlich mit Dichteinsatz gemäss EN 45545 / NFPA 130. Bei Anfragen oder Bestellung bitte ein F vor die Artikelnummer setzen.

Available with sealing inserts conformity with EN 45545 / NFPA 130. When placing an inquiry, prefix the article number by the capital F.



Kabelverschraubungen Progress® rostfreier Stahl A2 für hohe Temperaturen

Cable glands Progress® stainless steel A2 for high temperature applications

Langes Anschlussgewinde metrisch | Long entry thread metric

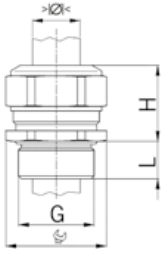

Material: Rostfreier CrNi-Stahl A2 (DIN EN 1.4305 / AISI 303)
 Kennzeichnung: 1 Rille
 Dichtung: FPM
 O-Ring: FPM
 Zugentlastung: Ausführung A nach EN 62444
 Schutzart: IP 68 (bis 10 bar) / IP 69
 Einsatztemperatur: -40 °C / +200 °C

Material: CrNi stainless steel A2 (DIN EN 1.4305 / AISI 303)
 Identification: 1 groove
 Seal: FPM
 O-ring: FPM
 Strain relief: Version A acc. to EN 62444
 Protection class: IP 68 (up to 10 bar) / IP 69
 Operation temperature: -40 °C / +200 °C



Progress S2 HT



Einteiliger Dichteinsatz
nicht durchgehend isolierend

One-piece sealing insert
not overall length insulated

G	>Ø< min mm	>Ø< max mm	Ø mm	H mm	L mm	i info	Art.-No.	
M8x1.25	2.5	3.5	11	14	10	1	1100.08.96.035	50
M8x1.25	3.5	5.0	11	14	10	1	1100.08.96.050	50
M10x1.5	3.0	4.0	13	15	10	1	1100.10.96.040	50
M10x1.5	4.0	6.0	13	15	10	1	1100.10.96.060	50
M12x1.5	3.5	5.0	17	17	10	-	1100.12.96.050	50
M12x1.5	5.0	6.5	17	17	10	-	1100.12.96.065	50
M12x1.5	6.5	8.0	17	17	10	-	1100.12.96.080	50
M16x1.5	8.0	10.5	19	20	10	-	1100.17.96.105	50
M20x1.5	11.0	15.0	24	21	10	-	1100.20.96.150	50
M25x1.5	16.0	20.5	30	25	11	-	1100.25.96.205	25
M32x1.5	21.0	25.5	36	28	13	-	1100.32.96.255	25
M40x1.5	28.5	33.0	46	31	13	-	1100.40.96.330	10
M50x1.5	37.0	42.0	55	34	14	-	1100.50.96.420	10
M63x1.5	46.0	52.0	70	37	14	-	1100.63.96.520	5

1 = Metrisches Regelgewinde (mit VDE Testreport)

1 = Metric coarse-pitch thread (with VDE test report)



Progress S2 HT



Zweiteiliger Dichteinsatz
nicht durchgehend isolierend

Two-piece sealing insert
not overall length insulated

G	>Ø< min mm	>Ø< max mm	>Ø< min mm	>Ø< max mm	Ø mm	H mm	L mm	Art.-No.	
M16x1.5	6.0	8.0	8.0	10.5	19	20	10	1100.17.96	50
M20x1.5	8.0	11.0	11.0	15.0	24	21	10	1100.20.96	50
M25x1.5	12.5	16.0	16.0	20.5	30	25	11	1100.25.96	25
M32x1.5	17.0	21.0	21.0	25.5	36	28	13	1100.32.96	25
M40x1.5	24.0	28.5	28.5	33.0	46	31	13	1100.40.96	10
M50x1.5	33.0	37.0	37.0	42.0	55	34	14	1100.50.96	10
M63x1.5	40.0	46.0	46.0	52.0	70	37	14	1100.63.96	5

Kabelverschraubungen Progress® rostfreier Stahl A2 für hohe Temperaturen

Cable glands Progress® stainless steel A2 for high temperature applications

Langes Anschlussgewinde Pg | Long entry thread Pg

Material: Rostfreier CrNi-Stahl A2 (DIN EN 1.4305 / AISI 303)
 Kennzeichnung: 1 Rille
 Dichtung: FPM
 O-Ring: FPM
 Schutzart: IP 68 (bis 10 bar) / IP 69
 Einsatztemperatur: -40 °C / +200 °C

Material: CrNi stainless steel A2 (DIN EN 1.4305 / AISI 303)
 Identification: 1 groove
 Seal: FPM
 O-ring: FPM
 Protection class: IP 68 (up to 10 bar) / IP 69
 Operation temperature: -40 °C / +200 °C

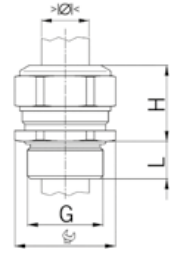

Einteiliger Dichteinsatz
 nicht durchgehend isolierend

One-piece sealing insert
 not overall length insulated

G	> Ø <	> Ø <	⊕	H	L	Art.-No.	
	min mm	max mm	mm	mm	mm		
Pg 7	3.5	5.0	17	17	10	1100.07.96.050	50
Pg 7	5.0	6.5	17	17	10	1100.07.96.065	50
Pg 7	6.5	8.0	17	17	10	1100.07.96.080	50
Pg 9	8.0	10.5	19	20	10	1100.09.96.105	50
Pg 11	8.5	12.0	22	21	10	1100.11.96.120	50
Pg 13	11.0	15.0	24	21	10	1100.13.96.150	50
Pg 16	11.0	15.0	24	21	10	1100.16.96.150	50
Pg 21	16.0	20.5	30	25	12	1100.21.96.205	25
Pg 29	23.0	27.5	41	28	12	1100.29.96.275	25
Pg 36	30.5	35.0	50	32	15	1100.36.96.350	10
Pg 42	37.0	42.0	55	34	15	1100.42.96.420	10
Pg 48	43.0	49.0	65	37	15	1100.48.96.490	10



Zweiteiliger Dichteinsatz
 nicht durchgehend isolierend

Two-piece sealing insert
 not overall length insulated

G	> Ø <	> Ø <	> Ø <	> Ø <	⊕	H	L	Art.-No.	
	min mm	max mm	min mm	max mm	mm	mm	mm		
Pg 9	6.0	8.0	8.0	10.5	19	20	10	1100.09.96	50
Pg 11	5.5	8.5	8.5	12.0	22	21	10	1100.11.96	50
Pg 13	8.0	11.0	11.0	15.0	24	21	10	1100.13.96	50
Pg 16	8.0	11.0	11.0	15.0	24	21	10	1100.16.96	50
Pg 21	12.5	16.0	16.0	20.5	30	25	12	1100.21.96	25
Pg 29	19.0	23.0	23.0	27.5	41	28	12	1100.29.96	25
Pg 36	26.0	30.5	30.5	35.0	50	32	15	1100.36.96	10
Pg 42	33.0	37.0	37.0	42.0	55	34	15	1100.42.96	10
Pg 48	37.0	43.0	43.0	49.0	65	37	15	1100.48.96	10



Langes Anschlussgewinde metrisch | Long entry thread metric

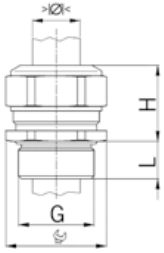

Material: Rostfreier und säurebeständiger CrNiMo-Stahl A4 (DIN EN 1.4435 / AISI 316L)
 Kennzeichnung: 2 Rillen
 Dichtung: FPM
 O-Ring: FPM
 Zugentlastung: Ausführung A nach EN 62444
 Schutzart: IP 68 (bis 10 bar) / IP 69
 Einsatztemperatur: -40 °C / +200 °C

Material: Stainless steel and acid resistant steel A4 CrNiMo (DIN EN 1.4435 / AISI 316L)
 Identification: 2 grooves
 Seal: FPM
 O-ring: FPM
 Strain relief: Version A acc. to EN 62444
 Protection class: IP 68 (up to 10 bar) / IP 69
 Operation temperature: -40 °C / +200 °C



Progress S4 HT



Einteiliger Dichteinsatz
 nicht durchgehend isolierend

One-piece sealing insert
 not overall length insulated

G	>Ø< min mm	>Ø< max mm	Ø mm	H mm	L mm	i info	Art.-No.	
M8x1.25	2.5	3.5	11	14	10	1	1100.08.98.035	50
M8x1.25	3.5	5.0	11	14	10	1	1100.08.98.050	50
M10x1.5	3.0	4.0	13	15	10	1	1100.10.98.040	50
M10x1.5	4.0	6.0	13	15	10	1	1100.10.98.060	50
M12x1.5	3.5	5.0	17	17	10	-	1100.12.98.050	50
M12x1.5	5.0	6.5	17	17	10	-	1100.12.98.065	50
M12x1.5	6.5	8.0	17	17	10	-	1100.12.98.080	50
M16x1.5	8.0	10.5	19	20	10	-	1100.17.98.105	50
M20x1.5	11.0	15.0	24	21	10	-	1100.20.98.150	50
M25x1.5	16.0	20.5	30	25	11	-	1100.25.98.205	25
M32x1.5	21.0	25.5	36	28	13	-	1100.32.98.255	25
M40x1.5	28.5	33.0	46	31	13	-	1100.40.98.330	10
M50x1.5	37.0	42.0	55	34	14	-	1100.50.98.420	10
M63x1.5	46.0	52.0	70	37	14	-	1100.63.98.520	5

1 = Metrisches Regelgewinde (mit VDE Testreport)

1 = Metric coarse-pitch thread (with VDE test report)



Progress S4 HT



Zweiteiliger Dichteinsatz
 nicht durchgehend isolierend

Two-piece sealing insert
 not overall length insulated

G	>Ø< min mm	>Ø< max mm	>Ø< min mm	>Ø< max mm	Ø mm	H mm	L mm	Art.-No.	
M16x1.5	6.0	8.0	8.0	10.5	19	20	10	1100.17.98	50
M20x1.5	8.0	11.0	11.0	15.0	24	21	10	1100.20.98	50
M25x1.5	12.5	16.0	16.0	20.5	30	25	11	1100.25.98	25
M32x1.5	17.0	21.0	21.0	25.5	36	28	13	1100.32.98	25
M40x1.5	24.0	28.5	28.5	33.0	46	31	13	1100.40.98	10
M50x1.5	33.0	37.0	37.0	42.0	55	34	14	1100.50.98	10
M63x1.5	40.0	46.0	46.0	52.0	70	37	14	1100.63.98	5

Langes Anschlussgewinde Pg | Long entry thread Pg

Material: Rostfreier und säurebeständiger CrNiMo-Stahl A4 (DIN EN 1.4435 / AISI 316L)
Kennzeichnung: 2 Rillen
Dichtung: FPM
O-Ring: FPM
Schutzart: IP 68 (bis 10 bar) / IP 69
Einsatztemperatur: -40 °C / +200 °C

Material: Stainless steel and acid resistant steel A4 CrNiMo (DIN EN 1.4435 / AISI 316L)
Identification: 2 grooves
Seal: FPM
O-ring: FPM
Protection class: IP 68 (up to 10 bar) / IP 69
Operation temperature: -40 °C / +200 °C

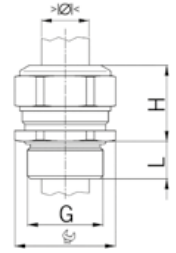

Einteiliger Dichteinsatz
nicht durchgehend isolierend

One-piece sealing insert
not overall length insulated

G	>Ø< min mm	>Ø< max mm	Ø mm	H mm	L mm	Art.-No.	
Pg 7	3.5	5.0	17	17	10	1100.07.98.050	50
Pg 7	5.0	6.5	17	17	10	1100.07.98.065	50
Pg 7	6.5	8.0	17	17	10	1100.07.98.080	50
Pg 9	8.0	10.5	19	20	10	1100.09.98.105	50
Pg 11	8.5	12.0	22	21	10	1100.11.98.120	50
Pg 13	11.0	15.0	24	21	10	1100.13.98.150	50
Pg 16	11.0	15.0	24	21	10	1100.16.98.150	50
Pg 21	16.0	20.5	30	25	12	1100.21.98.205	25
Pg 29	23.0	27.5	41	28	12	1100.29.98.275	25
Pg 36	30.5	35.0	50	32	15	1100.36.98.350	10
Pg 42	37.0	42.0	55	34	15	1100.42.98.420	10
Pg 48	43.0	49.0	65	37	15	1100.48.98.490	10



Zweiteiliger Dichteinsatz
nicht durchgehend isolierend

Two-piece sealing insert
not overall length insulated

G	>Ø< min mm	>Ø< max mm	>Ø< min mm	>Ø< max mm	Ø mm	H mm	L mm	Art.-No.	
Pg 9	6.0	8.0	8.0	10.5	19	20	10	1100.09.98	50
Pg 11	5.5	8.5	8.5	12.0	22	21	10	1100.11.98	50
Pg 13	8.0	11.0	11.0	15.0	24	21	10	1100.13.98	50
Pg 16	8.0	11.0	11.0	15.0	24	21	10	1100.16.98	50
Pg 21	12.5	16.0	16.0	20.5	30	25	12	1100.21.98	25
Pg 29	19.0	23.0	23.0	27.5	41	28	12	1100.29.98	25
Pg 36	26.0	30.5	30.5	35.0	50	32	15	1100.36.98	10
Pg 42	33.0	37.0	37.0	42.0	55	34	15	1100.42.98	10
Pg 48	37.0	43.0	43.0	49.0	65	37	15	1100.48.98	10



Kabelverschraubungen Progress® aqua rostfreier Stahl A2 für Trinkwasser

Cable glands Progress® aqua stainless steel A2 for drinking water

Langes Anschlussgewinde metrisch | Long entry thread metric

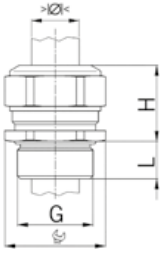

Material: Rostfreier CrNi-Stahl A2 (DIN EN 1.4305 / AISI 303)
 Kennzeichnung: Progress aqua
 Dichtung: EPDM
 O-Ring: EPDM
 Schutzart: IP 68 (bis 5 bar)
 Zertifikat: SVGW (1603-H6481)
 Materialprüfung: KTW W270
 Einsatztemperatur: -40 °C / +80 °C

Material: CrNi stainless steel A2 (DIN EN 1.4305 / AISI 303)
 Identification: Progress aqua
 Seal: EPDM
 O-ring: EPDM
 Protection class: IP 68 (up to 5 bar)
 Certificate: SVGW (1603-H6481)
 Material testing: KTW W270
 Operation temperature: -40 °C / +80 °C



Progress aqua



Einteiliger Dichteinsatz
 nicht durchgehend isolierend

One-piece sealing insert
 not overall length insulated

G	>Ø< min mm	>Ø< max mm	mm	H mm	L mm	Art.-No.	
M12x1.5	3.5	5.0	17	17	10	W1100.12.95.050	50
M12x1.5	5.0	6.5	17	17	10	W1100.12.95.065	50
M12x1.5	6.5	8.0	17	17	10	W1100.12.95.080	50
M16x1.5	8.0	10.5	19	20	10	W1100.17.95.105	50
M20x1.5	11.0	15.0	24	21	10	W1100.20.95.150	50
M25x1.5	16.0	20.5	30	25	11	W1100.25.95.205	25
M32x1.5	21.0	25.5	36	28	13	W1100.32.95.255	25
M40x1.5	28.5	33.0	46	31	13	W1100.40.95.330	10

Weitere Ausführungen und Anschlussgewinde
 auf Anfrage

Further versions and entry threads
 are available upon request.



<p>Kabelverschraubungen Progress® multiLAYER Messing Cable glands Progress® multiLAYER nickel-plated brass</p>		<p>69 - 71</p>	<p>1</p>
<p>Kabelverschraubungen Progress® ultraFLAT Cable glands Progress® ultraFLAT nickel-plated brass</p>		<p>72 - 73</p>	<p>2</p>
<p>Kabelverschraubungen Progress® Messing Winkel 90° Cable glands Progress® nickel-plated brass elbow 90°</p>		<p>74 - 76</p>	<p>4</p>
<p>Winkel 90° und 45° Messing mit Innen- und Aussengewinde Elbow 90° nickel-plated brass with internal and external thread</p>		<p>77 - 78</p>	<p>5</p>
<p>Flanschwinkel 90° Zinkdruckguss Flanged elbow 90° zinc diecasting</p>		<p>79</p>	<p>6</p>
<p>Universal Kabeleinführungen für Flach- und Rundkabel Universal cable entry for flat and round cables</p>		<p>80</p>	<p>7</p>
<p>Stopfbuchsen Messing nach DIN 46320-C4-MS Cable glands nickel-plated brass according to DIN 46320-C4-MS</p>		<p>81 - 82</p>	<p>9</p>
<p>Stopfbuchsen Messing mit Klemmbacken Cable glands nickel-plated brass with clamps</p>		<p>83</p>	<p>10</p>
<p>Stopfbuchsen Messing mit Trompete und Klemmbacken Cable glands nickel-plated brass with trumpet and clamps</p>		<p>84</p>	<p>11</p>
<p>Stopfbuchsen Messing mit Schutztülle und Klemmbacken Cable glands nickel-plated brass with antikink nozzle and clamps</p>		<p>85</p>	<p>12</p>

Spezielle Kabelverschraubungen und -einführungen aus Messing Special cable glands and cable entries nickel-plated brass



Die **Progress® ultraFLAT** ist eine Kabelverschraubung für vier Anwendungsgebiete – den Reinraum, die Lebensmittelindustrie, den Antivandalismus und das Design. Die ultraflache Konstruktion der Kabelverschraubung Progress® ultraFLAT verhindert eine Manipulation von aussen. Sie bietet keine Angriffsfläche für eine Beeinträchtigung von Hand oder auch mit Werkzeugen. Ausserdem überzeugt die Kabelverschraubung durch ihre schlichte und überaus ansprechende Formgebung für den Einsatz in Design-Applikationen.

Die Kabelverschraubung Progress® ultraFLAT bietet wenig Oberfläche, an der sich Verschmutzungen ablagern können. Die gute Reinigbarkeit spricht ebenfalls für den Einsatz in Reinräumen oder der Lebensmittelindustrie. Ausführungen in Edelstahl und Dichteinsätze für Hochtemperatur-Anwendungen oder mit FDA Konformität sprechen für diese Wahl.

Sind bei der Kabelinstallation enge Raumverhältnisse gegeben, kann der Anwender auf die Vorteile von **Winkeln und Flanschwinkeln** bauen. Hier werden Leitungen um die Ecke geführt und je nach der verwendeten Kabelverschraubung zu 100% vor der Knickstelle zugentlastet. Zur Auswahl stehen neben 90°-Winkeln auch 45°-Winkel für eine leichte Biegung des Kabels.

Progress® ultraFLAT is a cable gland for four application areas: Clean rooms, the food industry, anti-vandalism applications and where a stylish appearance is desired. The ultra-flat design of the **Progress® ultraFLAT** cable gland prevents tampering from the outside. It doesn't provide a surface for gripping by hand or with a tool. And thanks to its simple and very attractive design, the cable gland is also ideal for use where appearance matters.

The Progress® ultraFLAT cable gland has little surface area for dirt to collect. The good cleanability also makes it suitable use in clean rooms or the food industry. Stainless steel versions of this cable gland offer further benefits, as does the use of sealing inserts for high-temperature applications or complying with FDA requirements.

If space is at a premium the user can take advantage of the benefits of **elbow fittings – flanged and unflanged** – for cable installations. The cables are run around the bend and, depending upon the type of cable gland used, completely relieved of any strain before the kinking point. As well as 90° elbows, 45° elbows are also available for smaller cable bends.



Die Herstellung von Kabelbäumen wird vermehrt ausgelagert und externe Kabelkonfektionäre bewerkstelligen die Verkabelung von Antriebssystemen und Umformer. Da oftmals unterschiedliche Kabel verwendet werden, ist eine grössere Flexibilität im täglichen Handwerk gefragt. Mit der neuen **Progress® multiLAYER** muss pro Anschlussgewinde nur noch eine Kabelverschraubung bewirtschaftet werden.

Der neue **multiLAYER Dichteinsatz** bietet einen enorm grossen Klemmbereich und verfügt über einen integrierten Staubschutz für die Kabelverschraubung. Die geschlitzte Ausführung erlaubt eine schnelle Montage bei vorkonfektionierten Kabeln. Der Dichteinsatz nutzt die Progress® Kompressionstechnik und klemmt das Kabel schonend und ohne Einschnürung. Der neue Dichteinsatz kann problemlos mit anderen Komponenten des herausragenden Progress® Baukastens kombiniert werden.

The production of cable harnesses is increasingly outsourced, with external cable assemblers carrying out the cabling of drive systems and converters. Since cables of different types are often used, a high degree of flexibility is required in day-to-day work. With **Progress® multiLAYER**, only one type of cable gland is required per entry thread.

The new **multiLAYER sealing insert** offers great flexibility with respect to cable diameter, and features integrated dust protection for the cable gland. The splittable version allows quick installation on pre-assembled cables. Thanks to the Progress® compression technology, it clamps cables gently and without causing necking. Furthermore, this new sealing insert can be easily combined with other components of the outstanding modular Progress® product range.



Kabelverschraubungen Progress® multiLAYER Messing

Cable glands Progress® multiLAYER nickel-plated brass

Kurzes Anschlussgewinde metrisch | Short entry thread metric

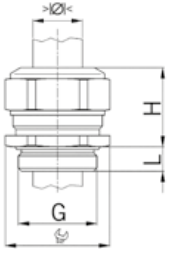

Material: Messing vernickelt
 Dichtung: Spezial AGRO TPE hellgrau
 O-Ring: NBR
 Zugentlastung: Ausführung A nach EN 62444
 Schutzart: IP 68 (bis 10 bar) / IP 69
 Einsatztemperatur: -50 °C / +105 °C

Material: Nickel-plated brass
 Seal: Special AGRO TPE light grey
 O-ring: NBR
 Strain relief: Version A acc. to EN 62444
 Protection class: IP 68 (up to 10 bar) / IP 69
 Operation temperature: -50 °C / +105 °C



Mehrteiliger Dichteinsatz
 nicht durchgehend isolierend

Multi-piece sealing insert
 not overall length insulated

G	\varnothing min mm	\varnothing max mm	\varnothing mm	H mm	L mm	Art.-No.	
M20x1.5	4.0	15.0	24	23	6	F1000.4.20	50
M25x1.5	6.0	20.5	30	28	7	F1000.4.25	25
M32x1.5	10.0	25.5	36	28	8	F1000.4.32	25



Langes Anschlussgewinde metrisch | Long entry thread metric



Mehrteiliger Dichteinsatz
 nicht durchgehend isolierend

Multi-piece sealing insert
 not overall length insulated

G	\varnothing min mm	\varnothing max mm	\varnothing mm	H mm	L mm	Art.-No.	
M20x1.5	4.0	15.0	24	23	10	F1100.4.20	50
M25x1.5	6.0	20.5	30	28	11	F1100.4.25	25
M32x1.5	10.0	25.5	36	28	13	F1100.4.32	25



Kabelverschraubungen Progress® multiLAYER Kunststoff GFK

Synthetic cable glands Progress® multiLAYER GFK

Anschlussgewinde metrisch | Entry thread metric

Material:	Polyamid glasfaserverstärkt	Material:	Polyamide glass fiber reinforced
Eigenschaften:	halogenfrei	Properties:	halogen-free
Dichtung:	TPE	Seal:	TPE
Zugentlastung:	Ausführung A nach EN 62444	Strain relief:	Version A acc. to EN 62444
Schutzart:	IP 68	Protection class:	IP 68
Einsatztemperatur:	-20 °C / +100 °C	Operation temperature:	-20 °C / +100 °C

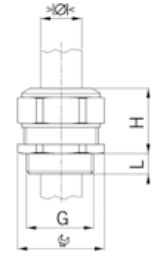

Mehrteiliger Dichteinsatz
Hellgrau RAL 7035

Multi-piece sealing insert
Light grey RAL 7035

G	> Ø <	> Ø <	mm	H	L	Art.-No.	
	min mm	max mm	mm	mm	mm		
M20x1.5	4.0	15.0	27	28	13	1571.4.20	50
M25x1.5	6.0	20.5	34	33	13	1571.4.25	25
M32x1.5	10.0	25.5	41	35	15	1571.4.32	25



Mehrteiliger Dichteinsatz
Schwarz RAL 9005

Multi-piece sealing insert
Black RAL 9005

G	> Ø <	> Ø <	mm	H	L	Art.-No.	
	min mm	max mm	mm	mm	mm		
M20x1.5	4.0	15.0	27	28	13	1540.4.20	50
M25x1.5	6.0	20.5	34	33	13	1540.4.25	25
M32x1.5	10.0	25.5	41	35	15	1540.4.32	25



Mehrteiliger Dichteinsatz
Weiss RAL 9010

Multi-piece sealing insert
White RAL 9010

G	> Ø <	> Ø <	mm	H	L	Art.-No.	
	min mm	max mm	mm	mm	mm		
M20x1.5	4.0	15.0	27	28	13	1520.4.20	50
M25x1.5	6.0	20.5	34	33	13	1520.4.25	25



Kabelverschraubungen Progress® ultraFLAT Messing

Cable glands Progress® ultraFLAT nickel-plated brass

Anschlussgewinde metrisch | Entry thread metric

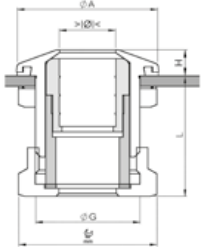

Frontring:	Messing halbglanz vernickelt	Front part:	semi-bright nickel-plated brass
Druckmutter:	Messing vernickelt	Push-down nut:	Nickel-plated brass
Dichtung:	TPE	Seal:	TPE
Dichtscheibe:	FPM	Sealing washer:	FPM
Zugentlastung:	Ausführung A nach EN 62444	Strain relief:	Version A acc. to EN 62444
Wandstärke:	max. 5 mm	Wall thickness:	max. 5 mm
Schutzart:	IP 68 (bis 10 bar) / IP 69	Protection class:	IP 68 (up to 10 bar) / IP 69
Einsatztemperatur:	-40 °C / +100 °C	Operation temperature:	-40 °C / +100 °C



Einteiliger Dichteinsatz
nicht durchgehend isolierend

One-piece sealing insert
not overall length insulated

G	>ØK< min mm	>ØK< max mm	Ømm	ØA mm	H mm	L mm	Art.-No.	
M16x1.5	5.0	6.5	19	22	4.0	21	1040.17.40.065	25
M16x1.5	6.5	8.0	19	22	4.0	21	1040.17.40.080	25
M20x1.5	6.0	8.0	24	27	4.5	23	1040.20.40.080	25
M20x1.5	8.0	10.5	24	27	4.5	23	1040.20.40.105	25
M25x1.5	8.0	11.0	30	32	5.5	25	1040.25.40.110	20
M25x1.5	11.0	15.0	30	32	5.5	25	1040.25.40.150	20
M32x1.5	12.5	16.0	36	39	6.0	28	1040.32.40.160	10
M32x1.5	16.0	20.5	36	39	6.0	28	1040.32.40.205	10

Auf Anfrage lieferbar:

Rostfreier und säurebeständiger Stahl A4

Available on request:

Stainless steel and acid resistant A4

Kabelverschraubungen Progress® ultraFLAT rostfreier Stahl A2

Cable glands Progress® ultraFLAT stainless steel A2

Anschlussgewinde metrisch | Entry thread metric

Frontring:	Rostfreier CrNi-Stahl A2 (DIN EN 1.4305 / AISI 303)	Front part:	CrNi stainless steel A2 (DIN EN 1.4305 / AISI 303)
Druckmutter:	Messing vernickelt	Push-down nut:	Nickel-plated brass
Dichtung:	FKM	Seal:	FKM
Dichtscheibe:	FKM	Sealing washer:	FKM
Zugentlastung:	Ausführung A nach EN 62444	Strain relief:	Version A acc. to EN 62444
Wandstärke:	max. 5 mm	Wall thickness:	max. 5 mm
Schutzart:	IP 68 (bis 10 bar) / IP 69	Protection class:	IP 68 (up to 10 bar) / IP 69
Einsatztemperatur:	-40 °C / +200 °C	Operation temperature:	-40 °C / +200 °C

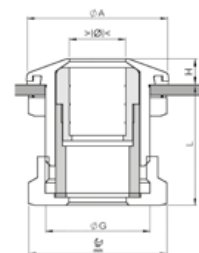

Einteiliger Dichteinsatz
nicht durchgehend isolierend

One-piece sealing insert
not overall length insulated

G	>10< min mm	>10< max mm	mm	ØA mm	H mm	L mm	i info	Art.-No.	
M16x1.5	5.0	6.5	19	22	4.0	21	1	1040.17.96.30.065	25
M16x1.5	6.5	8.0	19	22	4.0	21	1	1040.17.96.30.080	25
M20x1.5	6.0	8.0	24	27	4.5	23	1	1040.20.96.30.080	25
M20x1.5	8.0	10.5	24	27	4.5	23	1	1040.20.96.30.105	25
M25x1.5	8.0	11.0	30	32	5.5	25	1	1040.25.96.30.110	20
M25x1.5	11.0	15.0	30	32	5.5	25	1	1040.25.96.30.150	20
M32x1.5	12.5	16.0	36	39	6.0	28	1	1040.32.96.30.160	10
M32x1.5	16.0	20.5	36	39	6.0	28	1	1040.32.96.30.205	10

1 = Lieferbar auf Anfrage
FDA konforme Dichtungen

1 = Available on request
FDA-cleared sealings



Anschlussgewinde metrisch | Entry thread metric

Frontring:	Rostfreier CrNi-Stahl A2 (DIN EN 1.4305 / AISI 303)	Front part:	CrNi stainless steel A2 (DIN EN 1.4305 / AISI 303)
Druckmutter:	Messing vernickelt	Push-down nut:	Nickel-plated brass
Dichtung:	FPM	Seal:	FPM
Dichtscheibe:	FPM	Sealing washer:	FPM
Zugentlastung:	Ausführung A nach EN 62444	Strain relief:	Version A acc. to EN 62444
Wandstärke:	max. 5 mm	Wall thickness:	max. 5 mm
Schutzart:	IP 68 (bis 10 bar) / IP 69	Protection class:	IP 68 (up to 10 bar) / IP 69
Einsatztemperatur:	-40 °C / +200 °C	Operation temperature:	-40 °C / +200 °C

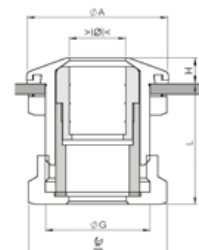

Einteiliger Dichteinsatz
nicht durchgehend isolierend

One-piece sealing insert
not overall length insulated

G	>10< min mm	>10< max mm	mm	ØA mm	H mm	L mm	i info	Art.-No.	
M16x1.5	5.0	6.5	19	22	4.0	21	-	1040.17.96.70.065	25
M16x1.5	6.5	8.0	19	22	4.0	21	-	1040.17.96.70.080	25
M20x1.5	6.0	8.0	24	27	4.5	23	1	1040.20.96.70.080	25
M20x1.5	8.0	10.5	24	27	4.5	23	-	1040.20.96.70.105	25
M25x1.5	8.0	11.0	30	32	5.5	25	1	1040.25.96.70.110	20
M25x1.5	11.0	15.0	30	32	5.5	25	-	1040.25.96.70.150	20
M32x1.5	12.5	16.0	36	39	6.0	28	1	1040.32.96.70.160	10
M32x1.5	16.0	20.5	36	39	6.0	28	-	1040.32.96.70.205	10

1 = Lieferbar auf Anfrage

1 = Available on request



Kabelverschraubungen Progress® Messing Winkel 90°

Cable glands Progress® nickel-plated brass elbow 90°

Kurzes Anschlussgewinde metrisch | Short entry thread metric

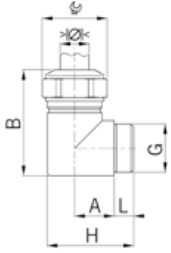

Material: Messing vernickelt
 Dichtung: TPE
 Zugentlastung: Ausführung A nach EN 62444
 Schutzart: IP 68
 Gewinde: IP 68, wenn Anschlussgewinde abgedichtet
 Einsatztemperatur: -40 °C / +100 °C

Material: Nickel-plated brass
 Seal: TPE
 Strain relief: Version A acc. to EN 62444
 Protection class: IP 68
 Entry thread: IP 68, if the entry thread is sealed
 Operation temperature: -40 °C / +100 °C



Progress MS W90



Zweiteiliger Dichteinsatz
nicht durchgehend isolierend

Two-piece sealing insert
not overall length insulated

G	>Ø< min mm	>Ø< max mm	>Ø< min mm	>Ø< max mm	mm	H mm	L mm	A mm	B mm	i info	Art.-No.	
M12x1.5	-	-	5.0	6.5	15	27	8	11	32	1	5200.12	50
M16x1.5	6.0	8.0	8.0	10.5	18	30	8	13	36	-	5200.17	50
M20x1.5	8.0	11.0	11.0	15.0	24	35	8	16	44	-	5200.20	50
M25x1.5	12.5	16.0	16.0	20.5	30	44	10	20	52	-	5200.25	25
M32x1.5	17.0	21.0	21.0	25.5	36	50	10	23	60	-	5200.32	25
M40x1.5	24.0	28.5	28.5	33.0	46	60	10	28	72	-	5200.40	10

1 = Einteiliger Dichteinsatz

1 = One-piece sealing insert

Erhältlich mit Dichteinsatz gemäss EN 45545 / NFPA 130.
Bei Anfragen oder Bestellung bitte ein F vor die Artikelnummer setzen.

Available with sealing inserts conformity with EN 45545 / NFPA 130. When placing an inquiry, prefix the article number by the capital F.

Langes Anschlussgewinde metrisch | Long entry thread metric



Progress MS W90



Zweiteiliger Dichteinsatz
nicht durchgehend isolierend

Two-piece sealing insert
not overall length insulated

G	>Ø< min mm	>Ø< max mm	>Ø< min mm	>Ø< max mm	mm	H mm	L mm	A mm	B mm	i info	Art.-No.	
M12x1.5	-	-	5.0	6.5	15	30	12	11	32	1	5210.12	50
M16x1.5	6.0	8.0	8.0	10.5	18	34	12	13	36	-	5210.17	50
M20x1.5	8.0	11.0	11.0	15.0	24	39	12	16	44	-	5210.20	50
M25x1.5	12.5	16.0	16.0	20.5	30	48	14	20	52	-	5210.25	25
M32x1.5	17.0	21.0	21.0	25.5	36	56	16	23	60	-	5210.32	25
M40x1.5	24.0	28.5	28.5	33.0	46	66	16	28	72	-	5210.40	10

1 = Einteiliger Dichteinsatz

1 = One-piece sealing insert

Erhältlich mit Dichteinsatz gemäss EN 45545 / NFPA 130.
Bei Anfragen oder Bestellung bitte ein F vor die Artikelnummer setzen.

Available with sealing inserts conformity with EN 45545 / NFPA 130. When placing an inquiry, prefix the article number by the capital F.

Kabelverschraubungen Progress® Messing Winkel 90° Cable glands Progress® nickel-plated brass elbow 90°

Kurzes Anschlussgewinde Pg | Short entry thread Pg

Material: Messing vernickelt
Dichtung: TPE
Schutzart: IP 68
Gewinde: IP 68, wenn Anschluss-
gewinde abgedichtet
Einsatztemperatur: -40 °C / +100 °C

Material: Nickel-plated brass
Seal: TPE
Protection class: IP 68
Entry thread: IP 68, if the entry thread
is sealed
Operation temperature: -40 °C / +100 °C

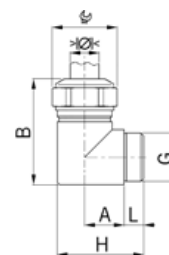

Zweiteiliger Dichteinsatz
nicht durchgehend isolierend

Two-piece sealing insert
not overall length insulated

G	> Ø <	> Ø <	> Ø <	> Ø <	mm	H	L	A	B	i	Art.-No.	mm
	min mm	max mm	min mm	max mm	mm	mm	mm	mm	mm	info		
Pg 7	-	-	5.0	6.5	15	27	8	11	32	1	5200.07	50
Pg 9	6.0	8.0	8.0	10.5	18	30	8	13	36	-	5200.09	50
Pg 11	5.5	8.5	8.5	12.0	21	35	8	14	40	-	5200.11	50
Pg 13	8.0	11.0	11.0	15.0	24	41	10	16	44	-	5200.13	50
Pg 16	8.0	11.0	11.0	15.0	24	41	10	16	44	-	5200.16	50
Pg 21	12.5	16.0	16.0	20.5	30	44	10	20	52	-	5200.21	25
Pg 29	19.0	23.0	23.0	27.5	38	56	10	24	65	-	5200.29	10

1 = Einteiliger Dichteinsatz

1 = One-piece sealing insert

Erhältlich mit Dichteinsatz gemäss EN 45545 / NFPA 130.
Bei Anfragen oder Bestellung bitte ein F vor die Artikel-
nummer setzen.

Available with sealing inserts conformity with EN 45545 /
NFPA 130. When placing an inquiry, prefix the article
number by the capital F.



Langes Anschlussgewinde Pg | Long entry thread Pg

Zweiteiliger Dichteinsatz
nicht durchgehend isolierend

Two-piece sealing insert
not overall length insulated

G	> Ø <	> Ø <	> Ø <	> Ø <	mm	H	L	A	B	i	Art.-No.	mm
	min mm	max mm	min mm	max mm	mm	mm	mm	mm	mm	info		
Pg 7	-	-	5.0	6.5	15	30	11	11	32	1	5210.07	50
Pg 9	6.0	8.0	8.0	10.5	18	34	11	13	36	-	5210.09	50
Pg 11	5.5	8.5	8.5	12.0	21	38	11	14	40	-	5210.11	50
Pg 13	8.0	11.0	11.0	15.0	24	44	13	16	44	-	5210.13	50
Pg 16	8.0	11.0	11.0	15.0	24	44	13	16	44	-	5210.16	50
Pg 21	12.5	16.0	16.0	20.5	30	48	14	20	52	-	5210.21	25
Pg 29	19.0	23.0	23.0	27.5	38	60	14	24	65	-	5210.29	10

1 = Einteiliger Dichteinsatz

1 = One-piece sealing insert

Erhältlich mit Dichteinsatz gemäss EN 45545 / NFPA 130.
Bei Anfragen oder Bestellung bitte ein F vor die Artikel-
nummer setzen.

Available with sealing inserts conformity with EN 45545 /
NFPA 130. When placing an inquiry, prefix the article
number by the capital F.



Kabelverschraubungen Progress® Messing Winkel 90°

Cable glands Progress® nickel-plated brass elbow 90°

Langes Anschlussgewinde metrisch mit Gegenmutter | Long entry thread metric with lock nut

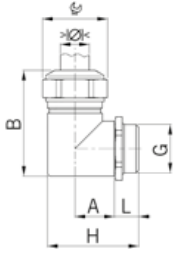

Material: Messing vernickelt
 Dichtung: TPE
 O-Ring: NBR
 Zugentlastung: Ausführung A nach EN 62444
 Schutzart: IP 68
 Einsatztemperatur: -40 °C / +100 °C

Material: Nickel-plated brass
 Seal: TPE
 O-ring: NBR
 Strain relief: Version A acc. to EN 62444
 Protection class: IP 68
 Operation temperature: -40 °C / +100 °C



Progress MS W90



Zweiteiliger Dichteinsatz
 nicht durchgehend isolierend

Two-piece sealing insert
 not overall length insulated

G	>Ø< min mm	>Ø< max mm	>Ø< min mm	>Ø< max mm	mm	H mm	L mm	A mm	B mm	i info	Art.-No.	
M12x1.5	-	-	5.0	6.5	15	30	12	11	32	1	5215.12	50
M16x1.5	6.0	8.0	8.0	10.5	18	34	12	13	36	-	5215.17	50
M20x1.5	8.0	11.0	11.0	15.0	24	39	12	16	44	-	5215.20	50
M25x1.5	12.5	16.0	16.0	20.5	30	48	14	20	52	-	5215.25	25
M32x1.5	17.0	21.0	21.0	25.5	36	56	16	23	60	-	5215.32	25
M40x1.5	24.0	28.5	28.5	33.0	46	66	16	28	72	-	5215.40	10

1 = Einteiliger Dichteinsatz

1 = One-piece sealing insert

Erhältlich mit Dichteinsatz gemäss EN 45545 / NFPA 130.
 Bei Anfragen oder Bestellung bitte ein F vor die Artikelnummer setzen.

Available with sealing inserts conformity with EN 45545 / NFPA 130. When placing an inquiry, prefix the article number by the capital F.

Langes Anschlussgewinde Pg mit Gegenmutter | Long entry thread Pg with lock nut

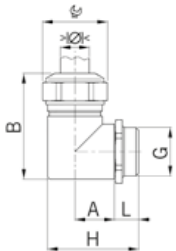

Material: Messing vernickelt
 Dichtung: TPE
 O-Ring: NBR
 Schutzart: IP 68
 Einsatztemperatur: -40 °C / +100 °C

Material: Nickel-plated brass
 Seal: TPE
 O-ring: NBR
 Protection class: IP 68
 Operation temperature: -40 °C / +100 °C



Zweiteiliger Dichteinsatz
 nicht durchgehend isolierend

Two-piece sealing insert
 not overall length insulated

G	>Ø< min mm	>Ø< max mm	>Ø< min mm	>Ø< max mm	mm	H mm	L mm	A mm	B mm	i info	Art.-No.	
Pg 7	-	-	5.0	6.5	15	30	11	11	32	1	5215.07	50
Pg 9	6.0	8.0	8.0	10.5	18	34	11	13	36	-	5215.09	50
Pg 11	5.5	8.5	8.5	12.0	21	38	11	14	40	-	5215.11	50
Pg 13	8.0	11.0	11.0	15.0	24	44	13	16	44	-	5215.13	50
Pg 16	8.0	11.0	11.0	15.0	24	44	13	16	44	-	5215.16	50
Pg 21	12.5	16.0	16.0	20.5	30	48	14	20	52	-	5215.21	25
Pg 29	19.0	23.0	23.0	27.5	38	60	14	24	65	-	5215.29	10

1 = Einteiliger Dichteinsatz

1 = One-piece sealing insert

Erhältlich mit Dichteinsatz gemäss EN 45545 / NFPA 130.
 Bei Anfragen oder Bestellung bitte ein F vor die Artikelnummer setzen.

Available with sealing inserts conformity with EN 45545 / NFPA 130. When placing an inquiry, prefix the article number by the capital F.

Winkel 90° Messing mit Innen- und Aussengewinde Elbow 90° nickel-plated brass with internal and external thread

Anschlussgewinde metrisch | Entry thread metric

Material: Messing vernickelt
 O-Ring: NBR
 Schutzart: IP 54
 Weitere Schutzart: IP 68, wenn Anschluss-
 gewinde abgedichtet
 Einsatztemperatur: -40 °C / +100 °C

Material: Nickel-plated brass
 O-ring: NBR
 Protection class: IP 54
 Further protection: IP 68, if the entry thread
 is sealed
 Operation temperature: -40 °C / +100 °C

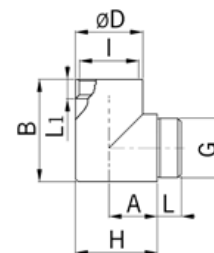

mit O-Ring

with O-ring

G	I	D	L	L1	A	B	H	Art.-No.	
		mm	mm	mm	mm	mm	mm		
M12x1.5	M12x1.5	15	5.0	7	13	25	20	5612	50
M16x1.5	M16x1.5	19	6.5	7	16	29	26	5617	50
M20x1.5	M20x1.5	24	6.0	10	19	37	31	5620	50
M25x1.5	M25x1.5	29	7.5	10	23	42	37	5625	25
M32x1.5	M32x1.5	36	8.5	11	26	50	44	5632	25
M40x1.5	M40x1.5	46	9.5	17	34	67	57	5640	10
M50x1.5	M50x1.5	56	9.0	17	41	77	69	5650	10



Anschlussgewinde Pg | Entry thread Pg

mit O-Ring

with O-ring

G	I	D	L	L1	A	B	H	Art.-No.	
		mm	mm	mm	mm	mm	mm		
Pg 7	Pg 7	16	7.0	7	13	23	21	5607	50
Pg 9	Pg 9	18	7.0	7	15	26	24	5609	50
Pg 11	Pg 11	22	8.0	8	18	31	29	5611	50
Pg 13	Pg 13	24	10.0	10	19	34	31	5613	50
Pg 16	Pg 16	26	10.0	10	20	36	33	5616	50
Pg 21	Pg 21	34	11.0	11	24	46	41	5621	25
Pg 29	Pg 29	41	11.0	11	28	52	49	5629	20
Pg 36	Pg 36	52	12.0	17	38	82	64	5636	10



Winkel 45° Messing mit Innen- und Aussengewinde

Elbows 45° nickel-plated brass with internal and external thread

Anschlussgewinde metrisch | Entry thread metric

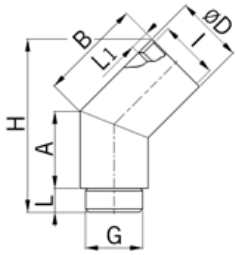

Material: Messing vernickelt
 O-Ring: NBR
 Schutzart: IP 54
 Weitere Schutzart: IP 68, wenn Anschluss-
 gewinde abgedichtet
 Einsatztemperatur: -40 °C / +100 °C

Material: Nickel-plated brass
 O-ring: NBR
 Protection class: IP 54
 Further protection: IP 68, if the entry thread
 is sealed
 Operation temperature: -40 °C / +100 °C



mit O-Ring

with O-ring

G	I	D	L	L1	A	B	H	Art.-No.	
		mm	mm	mm	mm	mm	mm		
M16x1.5	M16x1.5	19	6.5	7	13	18	26	5717	50
M20x1.5	M20x1.5	24	6.0	10	17	23	33	5720	50
M25x1.5	M25x1.5	29	7.5	10	18	25	36	5725	25
M32x1.5	M32x1.5	36	8.5	11	21	28	41	5732	25

Flanschwinkel 90° Zinkdruckguss

Flanged elbow 90° zinc diecasting

Anschlussgewinde metrisch | Entry thread metric

Material: Zinkdruckguss
 Dichtung: NBR
 Schutzart: IP 65
 Eigenschaften: Für spritzwasserdichte Montage an der Gehäusewandung mit Anschlussgewinde für Kabelverschraubung oder Schlauchverschraubung
 Einsatztemperatur: -40 °C / +100 °C

Material: Zinc diecasting
 Seal: NBR
 Protection class: IP 65
 Properties: For splash water-proof mounting on casing walls with entry thread for cable glands or conduit glands
 Operation temperature: -40 °C / +100 °C

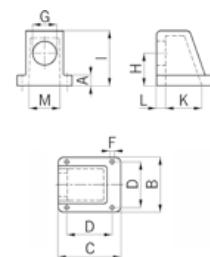

mit 1 Anschlussgewinde

with 1 entry thread

G	B/C mm	D mm	F mm	A mm	H mm	I mm	K mm	L mm	M mm	Art.-No.	
M16x1.5	45 x 48	37	4.3	8	15.5	30	28	10.5	24	5517	10
M20x1.5	53 x 56	44	5.5	8	18.0	35	34	10.5	24	5520	10
M25x1.5	63 x 65	54	5.5	8	22.5	42	43	11.0	35	5525	5
M32x1.5	71 x 75	60	5.5	10	27.0	52	53	11.0	38	5532	5
M40x1.5	71 x 75	60	5.5	10	27.0	52	53	11.0	38	5540	5
M50x1.5	89 x 93	72	6.5	11	33.5	69	65	18.0	50	5550	1
M63x1.5	96 x 114	84	4.3	10	37.0	74	86	14.0	67	5563	1



Anschlussgewinde Pg | Entry thread Pg

Material: Zinkdruckguss
 Farbe: Hammerschlaglackiert grau
 Dichtung: NBR
 Schutzart: IP 65
 Eigenschaften: Für spritzwasserdichte Montage an der Gehäusewandung mit Anschlussgewinde für Kabelverschraubung oder Schlauchverschraubung
 Einsatztemperatur: -40 °C / +100 °C

Material: Zinc diecasting
 Colour: Hammergrey enamel
 Seal: NBR
 Protection class: IP 65
 Properties: For splash water-proof mounting on casing walls with entry thread for cable glands or conduit glands
 Operation temperature: -40 °C / +100 °C

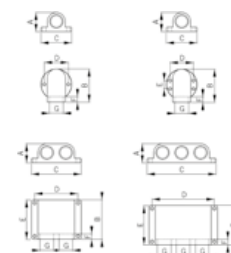

Mit 1 bis 3 Anschlussgewinden

With 1 to 3 entry threads

G		A mm	B mm	C mm	D mm	E mm	F mm	Art.-No.	
Pg 16	1	31	42	42	36.0	-	11	5516.10	10
Pg 21	1	40	60	60	52.5	-	12	5521.10	10
Pg 29	1	51.5	76	66	54.0	36	12	5529.10	10
Pg 36	1	62	90	85	73.0	30	12	5536.10	10
Pg 16	2	34	70	91	79.0	58	10	5516.12	10
Pg 16	3	34	70	124	111.0	56	10	5516.13	10



Universal Kabeleinführung für Flach- und Rundkabel

Universal cable entry for flat and round cables

Für Flach- und Rundkabel | For flat and round cables

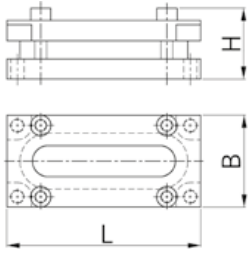

Material: Alu (AlMgSi0.5)
 Eigenschaften: Universal für ein oder mehrere Kabel, auch mit verschiedenen Abmessungen und Durchmessern. Max. Einbau von Flachkabeln 70x12 mm.
 Dichtung: NBR
 Schutzart: IP 54 - IP 68
 Einsatztemperatur: -40 °C / +100 °C

Material: Alu (AlMgSi0.5)
 Properties: Universally applicable for one or several cable(s) with various dimensions and diameters. Max. cable dimension 70x12 mm.
 Seal: NBR
 Protection class: IP 54 - IP 68
 Operation temperature: -40 °C / +100 °C



Aluminium Gehäuse zweiteilig
 Mit Dichtscheibe
 Universeller Dichtungseinsatz

Two-piece aluminium housing
 With sealing washer
 Universal sealing insert

L x B mm	∅ mm	H mm	i info	Art.-No.	
95x45	70.0x12.0	35	1	1370.15	5
95x45	49.0x4.5	35	2	1370.15.49.04	5
95x45	2x49.0x4.5	35	3	1370.15.49.45	5
95x45	63.0x12.0	35	4	1370.15.63.12	5
95x45	max.70.0x12.0	35	5	1370.15.30	5

Vollgummi-Dichteinsätze auf die entsprechende Kabeldimension aufbohren (Rundkabel Ø +1mm)

1 = Drill solid rubber inserts to match the appropriate cable diameter (round cables Ø +1 mm)

Dichteinsätze ohne Bohrung lassen sich gut bearbeiten, wenn sie vorher auf mindestens -25°C gefroren wurden.

When frozen to at least -25°C, the solid sealing inserts are easy to drill.

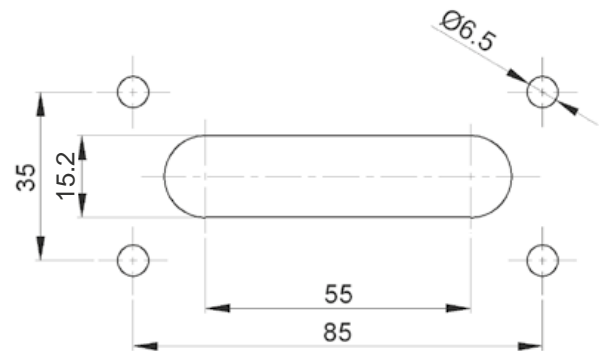
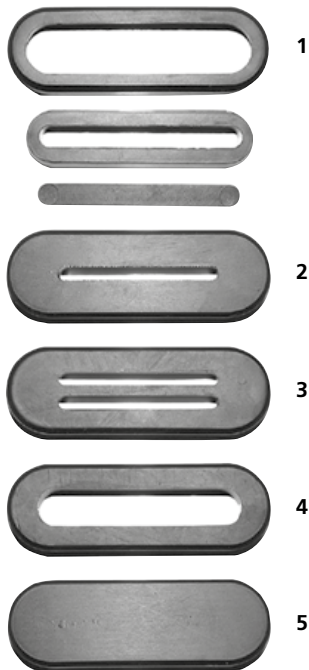

Stopfbuchsen Messing nach DIN 46320-C4-MS

Cable glands nickel-plated brass according to DIN 46320-C4-MS

Kurzes Anschlussgewinde metrisch | Short entry thread metric

Material: Messing vernickelt
 Dichtung: NBR
 Schutzart: IP 54
 Einsatztemperatur: -20 °C / +80 °C

Material: Nickel-plated brass
 Seal: NBR
 Protection class: IP 54
 Operation temperature: -20 °C / +80 °C

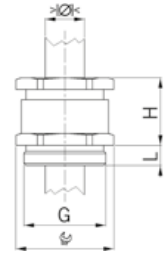

Einteiliger Einschnittring
 nicht durchgehend isolierend

One piece sealing ring
 not overall length insulated

G	$\begin{matrix} > \varnothing < \\ \text{min mm} \end{matrix}$	$\begin{matrix} > \varnothing < \\ \text{max mm} \end{matrix}$	$\begin{matrix} \varnothing \\ \text{mm} \end{matrix}$	H	L	Art.-No.	
	min mm	max mm	mm	mm	mm		
M12x1.5	5.0	7.0	14/13	15	5	B 112	100
M16x1.5	6.0	8.0	18/15	15	5	B 117	100
M20x1.5	8.0	10.0	22/18	19	6	B 120.10	50
M20x1.5	10.0	12.0	22/20	19	6	B 120.12	50
M20x1.5	12.0	14.0	22/20	19	6	B 120.14	50
M25x1.5	15.0	17.0	30/28	23	7	B 125	50
M32x1.5	24.0	26.0	40/37	26	8	B 132	25
M40x1.5	33.0	35.0	50/47	30	8	B 140	20
M50x1.5	39.0	41.0	57/54	34	9	B 150	10
M63x1.5	45.0	47.0	66/60	35	10	B 163	10



Langes Anschlussgewinde metrisch | Long entry thread metric

Einteiliger Einschnittring
 nicht durchgehend isolierend

One piece sealing ring
 not overall length insulated

G	$\begin{matrix} > \varnothing < \\ \text{min mm} \end{matrix}$	$\begin{matrix} > \varnothing < \\ \text{max mm} \end{matrix}$	$\begin{matrix} \varnothing \\ \text{mm} \end{matrix}$	H	L	Art.-No.	
	min mm	max mm	mm	mm	mm		
M12x1.5	5.0	7.0	14/13	15	10	B 212	100
M16x1.5	6.0	8.0	18/15	15	10	B 217	100
M20x1.5	8.0	10.0	22/18	19	10	B 220.10	50
M20x1.5	10.0	12.0	22/20	19	10	B 220.12	50
M20x1.5	12.0	14.0	22/20	19	10	B 220.14	50
M25x1.5	15.0	17.0	30/28	23	12	B 225	50
M32x1.5	24.0	26.0	40/37	26	12	B 232	25
M40x1.5	33.0	35.0	50/47	30	14	B 240	20
M50x1.5	39.0	41.0	57/54	34	14	B 250	10
M63x1.5	45.0	47.0	66/60	35	14	B 263	10



Stopfbuchsen Messing nach DIN 46320-C4-MS

Cable glands nickel-plated brass according to DIN 46320-C4-MS

Kurzes Anschlussgewinde Pg | Short entry thread Pg

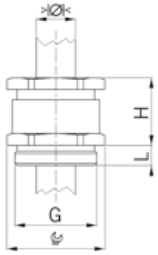

Material: Messing vernickelt
 Dichtung: NBR
 Schutzart: IP 54
 Einsatztemperatur: -20 °C / +80 °C

Material: Nickel-plated brass
 Seal: NBR
 Protection class: IP 54
 Operation temperature: -20 °C / +80 °C



Einteiliger Einschnittring
 nicht durchgehend isolierend

One piece sealing ring
 not overall length insulated

G	>Ø< min mm	>Ø< max mm	mm	H mm	L mm	Art.-No.	
Pg 7	5.0	7.0	14/13	15	5	B 107	50
Pg 9	4.0	10.0	17/15	15	5	B 109	50
Pg 11	6.5	12.0	20/18	17	6	B 111	50
Pg 13	6.5	13.5	22/20	20	6	B 113	50
Pg 16	6.5	16.0	24/22	22	6	B 116	50
Pg 21	9.0	20.0	30/28	24	7	B 121	50
Pg 29	17.0	28.0	40/37	26	8	B 129	25
Pg 36	23.0	34.0	50/47	30	9	B 136	10
Pg 42	29.0	40.0	57/54	34	10	B 142	10
Pg 48	35.0	46.0	64/60	37	10	B 148.48	10

Langes Anschlussgewinde Pg | Long entry thread Pg



Einteiliger Einschnittring
 nicht durchgehend isolierend

One piece sealing ring
 not overall length insulated

G	>Ø< min mm	>Ø< max mm	mm	H mm	L mm	Art.-No.	
Pg 9	4.0	10.0	17/15	15	15	B 209	50
Pg 11	6.5	12.0	20/18	17	15	B 211	50
Pg 13	6.5	13.5	22/20	20	15	B 213	50
Pg 16	6.5	16.0	24/22	22	15	B 216	50
Pg 21	9.0	20.0	30/28	24	15	B 221	50
Pg 29	17.0	28.0	40/37	26	15	B 229	25
Pg 36	23.0	34.0	50/47	30	15	B 236	10
Pg 42	29.0	40.0	57/54	34	15	B 242	10
Pg 48	35.0	46.0	64/60	37	15	B 248.48	10

Stopfbuchsen Messing mit Klemmbacken

Cable glands nickel-plated brass with clamps

Kurzes Anschlussgewinde metrisch | Short entry thread metric

Material: Messing vernickelt
 Dichtung: NBR
 Schutzart: IP 54
 Einsatztemperatur: -20 °C / +80 °C

Material: Nickel-plated brass
 Seal: NBR
 Protection class: IP 54
 Operation temperature: -20 °C / +80 °C

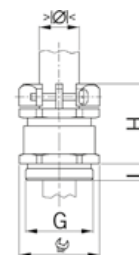

Einteiliger Einschnittring
 nicht durchgehend isolierend

One piece sealing ring
 not overall length insulated

G	> Ø <	> Ø <	mm	H	L	Art.-No.	
	min mm	max mm	mm	mm	mm		
M12x1.5	5.0	7.0	14/17	22	5	1803.12	50
M16x1.5	6.0	8.0	17/20	25	6	1803.17	50
M20x1.5	8.0	10.0	24/27	26	6	1803.20	50
M25x1.5	15.0	17.0	30/35	28	6	1803.25	25
M32x1.5	24.0	26.0	40/43	29	6	1803.32	25
M40x1.5	33.0	35.0	50/55	33	7	1803.40	10



Kurzes Anschlussgewinde Pg | Short entry thread Pg

Einteiliger Einschnittring
 nicht durchgehend isolierend

One piece sealing ring
 not overall length insulated

G	> Ø <	> Ø <	mm	H	L	Art.-No.	
	min mm	max mm	mm	mm	mm		
Pg 7	6.0	8.0	14/16	22	5	1803.07	50
Pg 9	8.0	10.0	17/19	25	6	1803.09	50
Pg 11	10.0	12.0	20/22	26	6	1803.11	50
Pg 13	12.0	14.0	22/24	27.5	6.5	1803.13	50
Pg 16	14.0	16.0	24/27	28.5	6.5	1803.16	50
Pg 21	14.0	16.0	30/34	33	7	1803.21	25
Pg 29	24.0	26.0	40/42	36	8	1803.29	25
Pg 36	30.0	32.0	50/52	41	9	1803.36	10
Pg 42	39.0	41.0	57/59	45	10	1803.42	10
Pg 48	45.0	47.0	64/64	48	10	1803.48.48	10



Stopfbuchsen Messing mit Trompete und Klemmbacken

Cable glands nickel-plated brass with trumpet and clamps

Kurzes Anschlussgewinde metrisch | Short entry thread metric

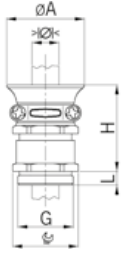

Material: Messing vernickelt
 Dichtung: NBR
 Schutzart: IP 54
 Einsatztemperatur: -20 °C / +80 °C

Material: Nickel-plated brass
 Seal: NBR
 Protection class: IP 54
 Operation temperature: -20 °C / +80 °C



Einteiliger Einschnittring
 nicht durchgehend isolierend

One piece sealing ring
 not overall length insulated

G	>Ø< min mm	>Ø< max mm	 mm	H mm	L mm	ØA mm	Art.-No.	
M16x1.5	6.0	8.0	18/17	29	5	22	1801.17	50
M20x1.5	8.0	10.0	22/20	31	6	26	1801.20.10	50
M20x1.5	10.0	12.0	22/22	32	6	29	1801.20.12	50
M20x1.5	12.0	14.0	22/24	34	6	32	1801.20.14	50
M25x1.5	15.0	17.0	30/30	37	7	38	1801.25	50
M32x1.5	24.0	26.0	40/41	43	8	50	1801.32	25

Kurzes Anschlussgewinde Pg | Short entry thread Pg



Einteiliger Einschnittring
 nicht durchgehend isolierend

One piece sealing ring
 not overall length insulated

G	>Ø< min mm	>Ø< max mm	 mm	H mm	L mm	ØA mm	Art.-No.	
Pg 9	6.0	9.0	17	29	6	22	1801.09	50
Pg 11	8.0	12.0	20	31	6	26	1801.11	50
Pg 13	9.0	14.0	22	32	6	29	1801.13	50
Pg 16	10.0	16.0	24	34	6	32	1801.16	50
Pg 21	14.0	21.0	30	37	7	38	1801.21	50
Pg 29	18.0	30.0	40	43	8	50	1801.29	25

Stopfbuchsen Messing mit Schutztülle und Klemmbacken

Cable glands nickel-plated brass with antikink nozzle and clamps

Kurzes Anschlussgewinde metrisch | Short entry thread metric

Material: Messing vernickelt
 Dichtung: NBR
 Knickschutztülle: NBR
 Schutzart: IP 65 wenn Anschluss-
 gewinde abgedichtet
 Einsatztemperatur: -20 °C / +80 °C

Material: Nickel-plated brass
 Seal: NBR
 antikink nozzle: NBR
 Protection class: IP 65 if the entry thread
 is sealed
 Operation temperature: -20 °C / +80 °C

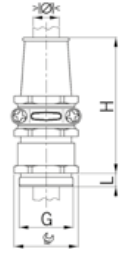

Einteiliger Einschnittring
 nicht durchgehend isolierend

One piece sealing ring
 not overall length insulated

G	$\begin{matrix} >D_1< \\ \text{min mm} \end{matrix}$	$\begin{matrix} >D_2< \\ \text{max mm} \end{matrix}$	$\begin{matrix} \text{mm} \\ \text{mm} \end{matrix}$	H	L	Art.-No.	
	min mm	max mm	mm	mm	mm		
M12x1.5	3.5	5.0	14/15	43	5	1852.12.05	25
M16x1.5	5.5	7.0	17/18	44	6	1852.16.07	25
M20x1.5	5.5	7.0	20/22	49	6	1852.20.07	25
M20x1.5	7.5	9.0	20/22	49	6	1852.20.09	25
M20x1.5	9.0	11.0	22/22	54	6	1852.20.11	25
M20x1.5	11.0	13.0	22/22	54	6	1852.20.13	25
M20x1.5	13.0	15.0	24/24	58	6	1852.20.15	25
M25x1.5	13.5	15.0	30/30	71	7	1852.25.15	25
M25x1.5	15.0	17.0	30/30	71	7	1852.25.17	25
M25x1.5	17.0	19.0	30/30	71	7	1852.25.19	25
M25x1.5	18.0	20.0	30/30	71	7	1852.25.20	25
M32x1.5	21.0	23.0	40/40	81	8	1852.32.23	1
M32x1.5	23.0	25.0	40/40	81	8	1852.32.25	1
M40x1.5	23.0	26.0	50/50	99	9	1852.40.26	1
M40x1.5	27.0	30.0	50/50	99	9	1852.40.30	1
M40x1.5	30.0	33.0	50/50	99	9	1852.40.33	1
M40x1.5	32.0	35.0	50/50	99	9	1852.40.35	1



Kurzes Anschlussgewinde Pg | Short entry thread Pg

Einteiliger Einschnittring
 nicht durchgehend isolierend

One piece sealing ring
 not overall length insulated

G	$\begin{matrix} >D_1< \\ \text{min mm} \end{matrix}$	$\begin{matrix} >D_2< \\ \text{max mm} \end{matrix}$	$\begin{matrix} \text{mm} \\ \text{mm} \end{matrix}$	H	L	Art.-No.	
	min mm	max mm	mm	mm	mm		
Pg 7	3.5	5.0	14/16	46	5	1852.07.05	50
Pg 9	5.5	7.0	17/19	45	6	1852.09.07	50
Pg 11	5.5	7.0	20/22	45	6	1852.11.07	50
Pg 11	7.5	9.0	20/22	49	6	1852.11.09	50
Pg 13	7.5	9.0	22/24	54	6	1852.13.09	25
Pg 13	9.0	11.0	22/24	54	6	1852.13.11	25
Pg 13	11.0	13.0	22/24	54	6	1852.13.13	25
Pg 16	11.5	13.0	24/27	58	6	1852.16.13	25
Pg 16	13.0	15.0	24/27	58	6	1852.16.15	25
Pg 21	13.5	15.0	30/34	71	7	1852.21.15	25
Pg 21	15.0	17.0	30/34	71	7	1852.21.17	25
Pg 21	17.0	19.0	30/34	71	7	1852.21.19	25
Pg 21	18.0	20.0	30/34	71	7	1852.21.20	25
Pg 29	18.0	20.0	40/42	71	8	1852.29.20	1
Pg 29	21.0	23.0	40/42	82	8	1852.29.23	1
Pg 29	23.0	25.0	40/42	82	8	1852.29.25	1
Pg 36	23.0	26.0	50/52	101	9	1852.36.26	1
Pg 36	27.0	30.0	50/52	101	9	1852.36.30	1
Pg 36	30.0	33.0	50/52	99	9	1852.36.33	1
Pg 36	32.0	35.0	50/52	99	9	1852.36.35	1
Pg 42	32.0	35.0	57/62	104	10	1852.42.35	1
Pg 42	35.0	38.0	57/62	104	10	1852.42.38	1
Pg 42	36.0	40.0	57/62	104	10	1852.42.40	1





	Progress® EMV Messing Progress® EMC nickel-plated brass	EMV easyCONNECT EMC easyCONNECT	EMV Rapid EMC Rapid	EMV Standard EMC Standard	EMV für Hochtemperatur EMC for high-temperature applications	EMV mit Knickschutzfeder EMC with anti-kink-spring	EMV powerCONNECT EMC powerCONNECT	EMV Serie 85 EMC Series 85	EMV Kombi-Schlauchverschraubung EMC combination conduit gland	EMV Hohlgeflechterschraubung EMC conduit gland for braiddings	EMV Zubehör EMC Accessories	EMV Gegenmutter mit Schneidzähnen EMC locknut with cutting teeth	Erdungsflaschen Grounding connectors
Ausführung / Design													
Kompressionstechnik Compression technology		•	•	•	•	•	•	•	•	-		-	-
EMV Technik / EMC technology													
Kontaktscheibe Contact disc		-	•	-	-	-	-	-	-	-		-	-
Kontaktfeder Contact spring		•	-	-	-	-	-	-	-	-		-	-
Kontakthülse Contact sleeve		-	•	•	•	•	-	-	•	•		-	-
Presshülse Compression ring		-	-	-	-	-	•	-	-	-		-	-
Spannzange Collet chuck		-	-	-	-	-	-	•	-	-		-	-
Gewinde / Thread													
Kurzes Anschlussgewinde (Standard) Short entry thread (standard)		•	•	•	•	•	•	•	A	A		•	•
Langes Anschlussgewinde Long entry thread		•	•	•	•	A	•	A	•	•		-	-
Anschlussgewinde Pg Pg entry thread		A	•	•	•	•	A	A	•	A		•	•
Dichteinsatz / Sealing insert													
Für Rundkabel For round cables		•	•	•	•	•	•	•	•	•		-	-
Für Schläuche For conduits		-	-	-	-	-	-	-	•	•		-	-
Einteiliger Dichteinsatz One-piece sealing insert		A	•	•	•	•	A	A	•	A		-	-
Zweiteiliger Dichteinsatz Two-piece sealing insert		•	-	-	-	-	•	•	-	-		-	-
Multi-Dichteinsatz Sealing insert for several cables		•	-	-	A	-	-	-	-	-		-	-
TPE-Dichteinsatz (Standard) TPE sealing insert (standard)		•	•	•	-	•	•	•	•	-		-	-
FPM-Dichteinsatz FPM sealing insert		A	A	-	•	A	A	A	A	-		-	-
Dichteinsatz nach EN 45545 Sealing insert acc. to EN 45545		A	A	A	-	A	•	•	-	-		-	-
Anwendung / Application													
Zugentlastung Strain relief		•	•	•	•	•	•	•	•	-		-	-
Knickschutz Anti-kink protection		-	-	-	-	•	-	-	-	-		-	-
Schirmgeflecht wird weitergeführt With continuation of braided shield		•	•	-	-	-	-	•	-	-		-	-
Schirmgeflecht wird nicht weitergeführt Without continuation of braided shield		•	•	•	•	•	•	•	•	•		-	-
Variabler Schirm-Klemmbereich Variable shield clamping range		+++	++	+	+	+	+++	+	+	+		-	-
Niedrige Transferimpedanz Low transfer impedance		++	+	++	++	++	+++	+++	++	++		-	-
Hohe Ableitströme (1.6 kA - 3 kA) High leakage currents (1.6 kA - 3 kA)		-	-	-	-	-	+++	+++	-	-		-	-
Demontierbarkeit ohne Beschädigung des Kabelschirms Can be removed without damaging the shield		+++	-	+	+	+	++	++	-	-		-	-
Installationsfreundlichkeit (kleiner Zeitaufwand) Easy installation (quick assembly)		++	+++	+	+	+	+	+	+	+		-	-

• trifft zu / lieferbar applies / available - trifft nicht zu / nicht lieferbar does not apply / not available +++ hervorragend geeignet extremely well suited ++ sehr gut geeignet very well suited + gut geeignet well suited A auf Anfrage upon request



<p>Kabelverschraubungen Progress® EMV easyCONNECT Messing mit Kontaktfeder Cable glands Progress® EMC easyCONNECT nickel-plated brass with contact spring</p>		<p>93</p>	<p>1</p>
<p>Kabelverschraubungen Progress® EMV Rapid Messing mit Kontaktscheibe Cable glands Progress® EMC Rapid nickel-plated brass with contact disc</p>		<p>94 - 95</p>	<p>2</p>
<p>Kabelverschraubungen Progress® EMV Messing mit Kontakthülse Cable glands Progress® EMC nickel-plated brass with contact sleeve</p>		<p>96 - 99</p>	<p>3</p>
<p>Kabelverschraubungen Progress® EMV Messing mit Kontakthülse für hohe Temperaturen Cable glands Progress® EMC nickel-plated brass with contact sleeve for high temperature applications</p>		<p>100 - 101</p>	<p>5</p>
<p>Kabelverschraubungen Progress® EMV Messing mit Knickschutzfeder Cable glands Progress® EMC nickel-plated brass with antikink spring</p>		<p>102 - 103</p>	<p>6</p>
<p>Kabelverschraubungen Progress® EMV powerCONNECT Messing Cable glands Progress® EMC powerCONNECT nickel-plated brass</p>		<p>104</p>	<p>7</p>
<p>Kabelverschraubungen Progress® EMV Serie 85 Messing mit Spannzange Cable glands Progress® EMC Series 85 nickel-plated brass with collet chuck</p>		<p>105 - 106</p>	<p>9</p>
<p>Zubehör zu EMV-Kabelverschraubungen EMC cable gland accessories</p>		<p>107 - 108</p>	<p>10</p>

11

12

13

14

15



Die elektromagnetische Verträglichkeit (EMV) im industriellen Umfeld besitzt einen besonderen Stellenwert, da gerade komplexe Maschinen und Anlagen äusserst anfällig für elektromagnetische Störungen sind. Den unerwünschten EMV-Effekten lässt sich jedoch mit einer wirkungsvollen Schirmung aller Komponenten entgegensteuern. Eine gute Schirmung reduziert einerseits die Störaussendung eines elektrischen Betriebsmittels und verringert gleichzeitig dessen Anfälligkeit für elektromagnetische Beeinträchtigungen.

Allerdings müssen nicht nur die Kabel selbst, sondern auch die restlichen Installationskomponenten einen Schirmcharakter aufweisen. Kabelverschraubungen als passive Bauteile müssen sicherstellen, dass die Qualität der Schirmung an den sensiblen Verbindungsstellen erhalten bleibt und es keine Schirmungsverluste gibt. Insofern ist es notwendig, nicht nur eine maximal geschirmte Leitung zu verwenden, sondern auch EMV-gerechte Kabelverschraubungen einzusetzen. Obwohl für diese Bauteile keine eigenständige EMV-Norm existiert, tragen sie wesentlich dazu bei, dass die vorgeschriebenen EMV-Auflagen der Hersteller erfüllt werden können.

Mit sechs unterschiedlichen, EMV-gerechten Kabelverschraubungen bieten wir dem Kunden das passende Produkt und die ideale Kontaktierungsvariante für jeden Anwendungsfall. Bei der Kabelverschraubung Progress® EMV easyCONNECT und auch easyCONNECT Multi Messing erfolgt die Kontaktierung über eine innovative Federklammer. Bei der neuen Progress® EMV powerCONNECT garantiert die fortschrittliche Presshülse eine sichere 360° Schirmkontaktierung auf kleinstem Raum.

Alle Produktreihen zeichnen sich durch eine leichte Montage aus. AGRO EMV-Kabelverschraubungen weisen ausserdem eine niedrige Transferimpedanz und hohe Strombelastbarkeit aus. Beides sind gängige Gütekriterien für die Qualität einer Schirmung.

Electromagnetic compatibility (EMC) plays a key role in the industrial sector because complex machines and systems are extremely susceptible to electromagnetic interference. Such undesired EMC effects, however, can be counteracted by ensuring effective shielding of all components. Good shielding reduces the amount of interference emitted by an electrical apparatus while at the same time reducing its own susceptibility to electromagnetic interference.

Not only the cables themselves but also all other components that are part of the installation must be adequately shielded. As passive components, cable glands must ensure that the quality of the shielding at sensitive interconnection points is maintained and that there are no shielding losses. For this reason, it is necessary not only to use an optimally shielded cable but also to use EMC-compatible cable glands. Although there is no stand-alone EMC standard for these components, they contribute strongly towards making it possible to meet the EMC requirements specified by manufacturers.

With six different EMC-compatible cable glands, we offer our customers the appropriate product and the ideal type of contact for each application. With the Progress® EMC easyCONNECT and easyCONNECT Multi brass cable glands, contact is established by means of an innovative spring clip. With the new Progress® EMC powerCONNECT cable gland, its advanced compression ring ensures reliable 360° shield contact in a very compact unit.

All these product lines are characterised by their ability to be easily installed. AGRO EMC cable glands also exhibit low transfer impedance and high current – carrying capacity – both of which are well-established criteria for the quality of shielding.

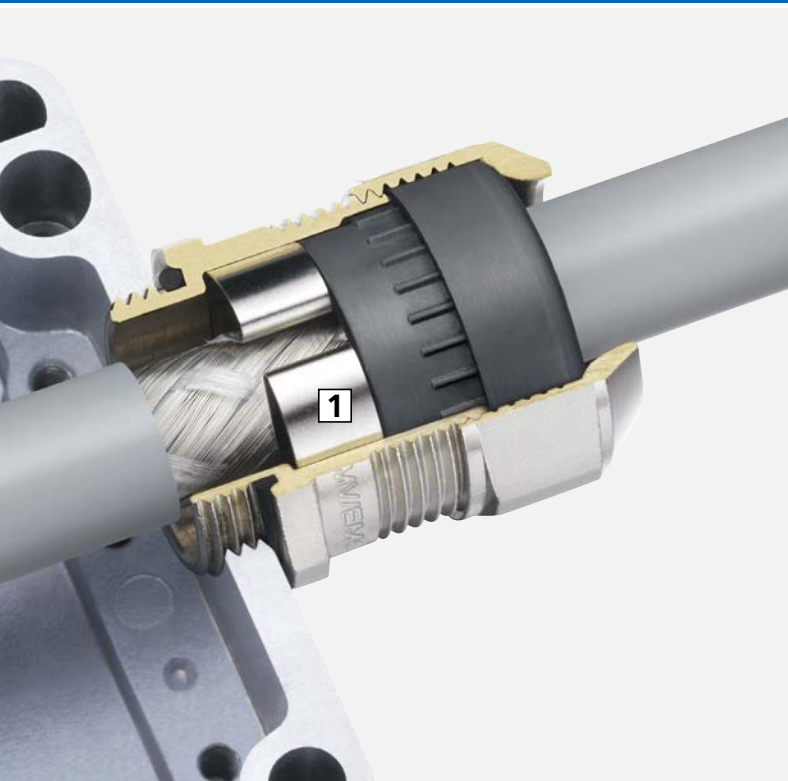

Progress® EMV easyCONNECT Messing

Die **Kabelverschraubung Progress® EMV easyCONNECT** gewährleistet volle Installationskontrolle und gleicht Toleranzen in den Schirmdicken für einen sicheren Schirmabgriff aus. Das Federsystem ermöglicht eine gute und sichere Schirmkontaktierung sowohl bei partiell abisolierten Abschirmkabeln als auch bei vollständig freigelegten Kabelschirmen.

1 Optimale Schirmkontaktierung

Die kraftvolle, schonende Klemmung des Kabelschirms garantiert einen hervorragenden Schirmkontakt und sorgt für extrem niedrige Transferimpedanzen. Durch die spezielle Formgebung der Kontaktfeder ist nicht nur ein grosser Schirmklemmbereich, sondern auch die Demontierbarkeit der Kabelverschraubung ohne Zerstörung des EMV-Geflechtes gegeben.

Progress® EMC easyCONNECT nickel-plated brass

The **Progress® EMC easyCONNECT cable gland** ensures full control during installation and compensates for tolerances in shield thickness to ensure a reliable shield grip. The spring system facilitates good, reliable shield contact for either partially or fully stripped shielded cables.

1 Optimal shield contact

The strong, cable-friendly clamping of the cable shield ensures excellent shield contact and extremely low transfer impedance. The shape of the contact spring facilitates not only a large shield clamping range but also easy removal of the cable gland without damaging the EMC braiding.

Progress® EMV easyCONNECT Multi

Die **Progress® easyCONNECT Multi** ist die erste Kabelverschraubung, die das Einführen von mehreren geschirmten Kabeln in ein Gehäuse erlaubt – und dies mit kraftvollem und sicherem Schirmabgriff. Bei einem kleinen Installationsraum für geschirmte Leitungen ist die Progress® EMV easyConnect Multi genau das richtige. Egal, ob die zu verarbeitenden Kabel immer den gleichen oder unterschiedliche Durchmesser aufweisen, ob es sich um vorkonfektionierte oder unkonfektionierte Leitungen oder Hybridkabel handelt: Durch die innovative Kontaktfeder ist eine problemlose Erdung möglich.

Progress® EMC easyCONNECT Multi

Progress® easyCONNECT Multi is the first cable gland that allows for the entry of multiple shielded cables into a housing or cabinet while ensuring a strong, reliable shield grip.

For shielded cables that require to be installed where space is limited, Progress® EMC easyCONNECT Multi is the perfect solution. Whether for cables of the same or different diameters, or for pre-assembled, non-preassembled or hybrid cables: The innovative contact spring facilitates problem-free earthing.

Sechs unterschiedliche Kontaktierungsvarianten

Six different contact types

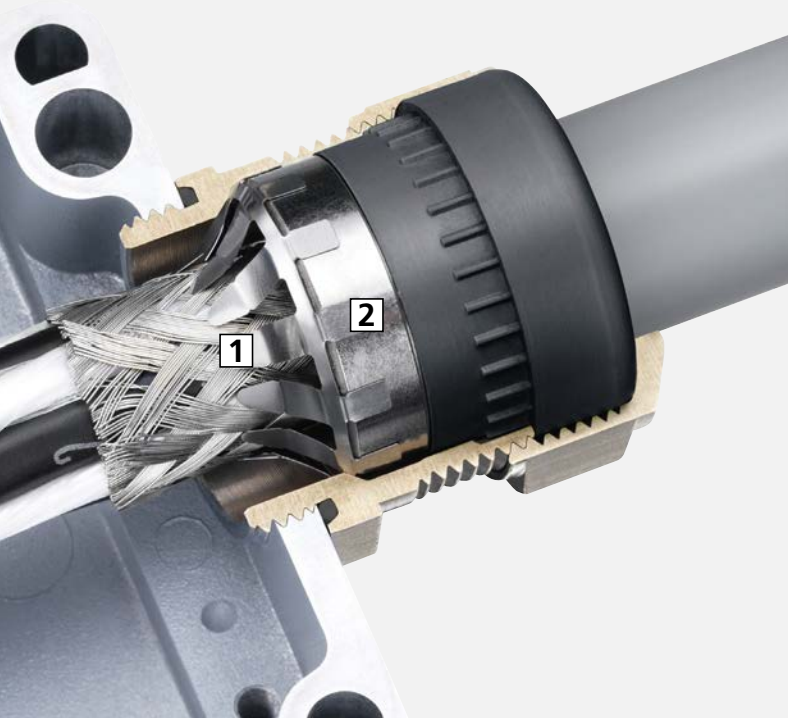

Progress® EMV Rapid Messing

Die **Kabelverschraubung mit den zwei Kontaktierungsvarianten** für eine sehr schnelle und einfache Schirmkontaktierung durch eine integrierte Kontaktscheibe. Sie ermöglicht die gute Kontaktierung sowohl von partiell abisolierten Abschirmkabeln als auch von vollständig freigelegten Kabelschirmen, die auch weitergeführt werden können.

1 Niedriger Übergangswiderstand

Die grossflächigen, flexiblen Zungen der Kontaktscheibe maximieren die Abgriffsfläche am Schirmgeflecht und erlauben eine zeitsparende Montage.

2 Flexible Kontaktierungsmöglichkeiten

Für eine höherwertige 360° Schirmkontaktierung, kann die Kontaktscheibe ausgestossen werden und das zugeschnittene Schirmgeflecht über die Kontakthülse direkt mit der Kontaktfläche im Unterteil der Kabelverschraubung kontaktiert werden.

Progress® EMC Rapid nickel-plated brass

The **cable gland with two contact options**, facilitating quick and easy shield contact by means of an integrated contact element with flexible protruding strips. This enables good contact to be achieved with partially stripped shielded cables or with fully exposed cable shields, which may also be extended.

1 Low contact resistance

The contact element's large, flexible protruding strips maximise the gripping area on the shield braiding, facilitating time-saving installation.

2 Flexible possibilities for creating the contact

For a superior 360°-contact, the contact element can be pushed out and the trimmed shield can be placed directly against the contact surface on the cable gland's lower part, via the contact sleeve.



Progress® EMV Messing

Kabelverschraubungen Progress® EMV aus Messing mit der bewährten Kontakthülse ermöglichen eine Schirmkontaktierung von 360° bei in der Kabelverschraubung endendem Schirmgeflecht. Die massgebende Kantengeometrie der Kontakthülse verhindert hierbei ein Abscheren des Schirmgeflechts.

1 Kleinste Übergangswiderstände

Der konzentrische Schirmabgriff von 360° bürgt für kleinste Übergangswiderstände.

2 Permanenter Kontaktdruck

Die ineinandergreifende Kombination „Dichteinsatz-Kontakthülse“ garantiert einen permanenten Kontaktdruck des Schirmgeflechts am Unterteil.

Progress® EMC nickel-plated brass

The **Progress® EMC cable gland of brass with its well-proven contact sleeve** facilitates 360°-contact with shield braiding that ends in the cable gland. The appropriate edge geometry of the contact sleeve prevents any shearing off of the shield braiding.

1 Extremely low contact resistance

The concentric 360° shield grip ensures very low contact resistance.

2 Constant contact pressure

The interlocking “sealing insert/contact sleeve” combination ensures constant and enduring contact pressure between the shield braiding and the cable gland's lower part.

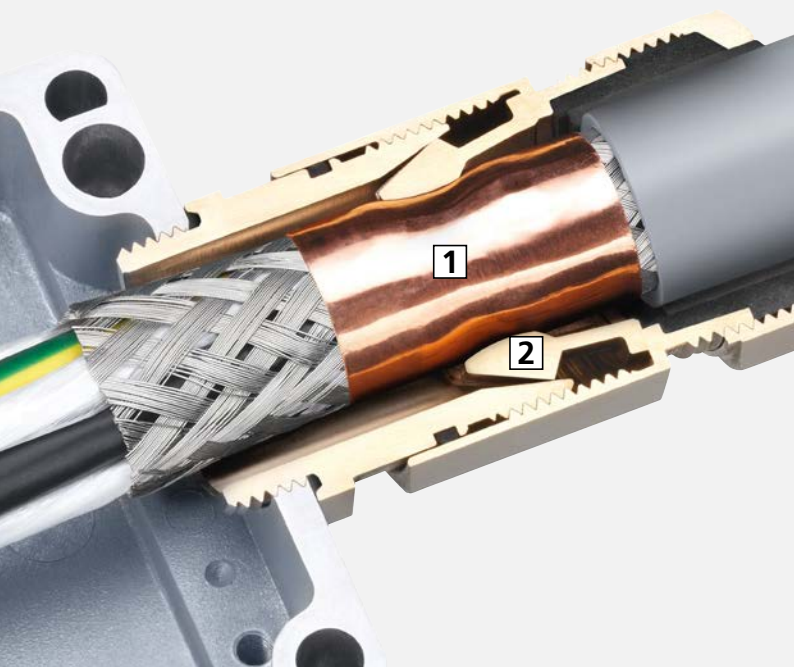

Progress® EMV Serie 85 Messing

Die patentierten Kabelverschraubungen **Progress® EMV Serie 85** aus Messing sorgen für eine besonders niederimpedante Verbindung zwischen Schirmgeflecht und Metallgehäuse bei gleichzeitig sicherer Kabeleinführung.

1 Optimale Schirmkontaktierung

Das Zwischenstück mit den grossen Schlüsselflächen ermöglicht eine einwandfreie Kontaktierung des Schirmgeflechtes durch die wegverstärkenden Spannzangensegmente über 360°. Das Kupferband sorgt für eine gleichmässige Kraftverteilung der Spannzange auf das Schirmgeflecht.

2 Höchste Ableitströme

Die massive Spannzange gewährleistet einen konzentrischen, niederimpedanten Schirmabgriff und bewältigt dauerhaft Ableitströme bis 1.6 kA – kurzzeitig 3 kA.

Progress® EMC Series 85 of nickel-plated brass

The patented **Progress® EMC Series 85** of nickel-plated brass provides an especially low-impedance connection between braided shield and metal cabinet while ensuring safe and reliable cable entry.

1 Optimal shield contact

The intermediate piece with the large spanner flats facilitates flawless 360° contact of the braided shield by means of the collet chuck design with its protrusions of increasing thickness with distance from the free end. The copper sheeting around the braided shield provides for an even distribution of force from the collet chuck.

2 Very high leakage currents

The compact collet chuck element ensures a concentric, low-impedance shield grip and can handle continuous leakage currents of up to 1.6 kA – and short term of up to 3 kA.

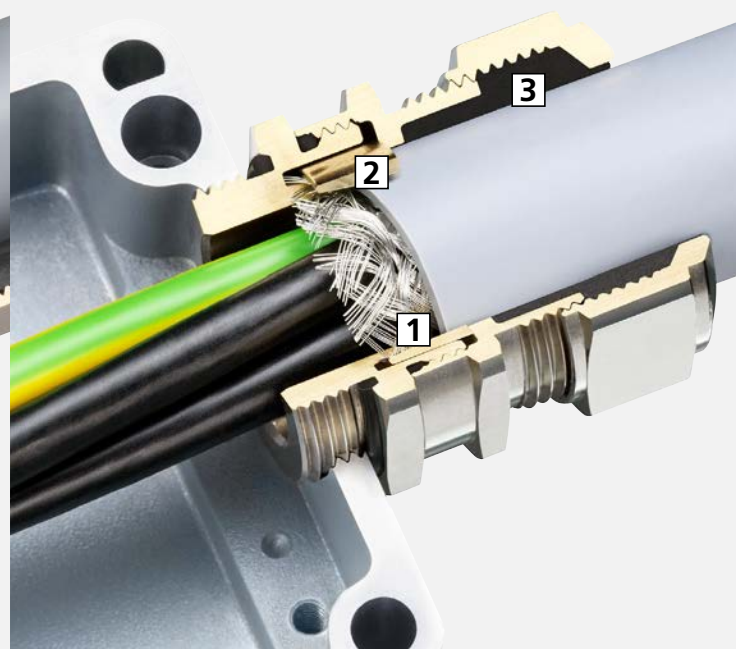

Progress® EMV powerCONNECT

Die **Progress® EMV powerCONNECT** mit der neuartigen fortschrittlichen Presshülse garantiert eine sichere 360° Schirmkontaktierung. Der direkte Übergang vom Geflecht auf das Unterteil der Kabelverschraubung gewährleistet einen erstaunlich niedrigen Übergangswiderstand. Dank geringer Bauhöhe eignet sich die Verschraubung ideal für den Einsatz in kleinstem Raum.

1 Geringe Übergangswiderstände

Durch den direkten Kontakt Geflecht-Kabelverschraubungskonus ergeben sich äusserst geringe Übergangswiderstände.

2 Höchste Ableitströme

Dauerhaft hoher Kontaktdruck durch die fixierte Presshülse und das Anziehen des Zwischenstücks auf Block ermöglichen höchste Ableitströme welche nur durch den Schirmquerschnitt begrenzt werden.

3 Grosse Flexibilität

Hohe Dichtigkeit bei grosser Flexibilität. Die zweiteiligen Dichteinsätze ermöglichen eine grosse Bandbreite im Klemmbereich bei unveränderter Schutzart (IP 68 / IP 69).

Progress® EMC powerCONNECT

The **Progress® EMC powerCONNECT cable gland**, with its innovative, highly advanced compression ring design, ensures reliable 360° shield contact. The direct transition from the braiding to the cable gland's lower part ensures very low contact resistance. Thanks to the compactness of its design, this cable gland is ideal for use where space is very limited.

1 Low contact resistance

As a result of the direct contact between the cable's shielding and the cable gland's tapered element, contact resistance is very low.

2 Very high leakage currents

Lasting high contact pressure, which results from the fixed compression ring and the complete tightening of the middle piece, maximises grounding of leakage currents, the extent of which is limited only by the shield's cross-sectional area.

3 High flexibility

Excellent sealing performance with high flexibility. The two-part sealing inserts facilitate a wide clamping range for a particular protection class (IP 68 / IP 69).

Progress EMV easyCONNECT Multi | Progress EMC easyCONNECT Multi

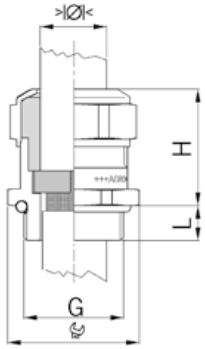

Material: Messing vernickelt
 Kontaktfeder: Federstahl 1.4310
 Dichtung: TPE
 O-Ring: NBR
 Zugentlastung: Ausführung A nach EN 62444
 Einsatztemperatur: -40°C / +100°C
 Schutzart: IP 68 (bis 10 bar) / IP 69
 Anwendungen: Für zeitsparende und sichere Montage von partiell abisolierten sowie durchgehend geschirmten Kabeln

Material: Nickel-plated brass
 Contact spring: Spring steel 1.4310
 Seal: TPE
 O-ring: NBR
 Strain relief: Version A acc. to EN 62444
 Temperature range: -40°C to +100°C
 Protection class: IP 68 (up to 10 bar) / IP 69
 Applications: For quick and reliable installation of partially stripped cables or continuously shielded cables



Einteiliger Dichteinsatz
 nicht durchgehend isolierend

One-piece sealing insert
 Not continuously isolating

Bei einem kleinen Installationsraum für geschirmte Leitungen ist Progress® EMV easyConnect Multi genau das richtige. Egal, ob die zu verarbeitenden Kabel immer den gleichen oder unterschiedliche Durchmesser aufweisen, ob es sich um vorkonfektionierte oder unkonfektionierte Leitungen oder Hybridkabel handelt: Durch die innovative Kontaktfeder ist eine problemlose Erdung möglich. Anhand der aufgeführten Bilder sehen Sie nur einen kleinen Ausschnitt der vielen Möglichkeiten.

For shielded cables in limited space conditions, Progress® EMC easyConnect Multi is the perfect solution. Whether for cables of the same or different diameters, or for preassembled, non-preassembled or hybrid cables: The innovative contact spring facilitates problem-free earthing. The presented pictures show only a small selection of the many possibilities.

You specify the number of cable entries and the relevant diameters, and we will supply the EMC Multi cable gland to meet your needs.

Sie definieren Anzahl und Durchmesser der Kabeleinführungen – wir liefern Ihnen Ihre individuelle EMV-Multi-Kabelverschraubung.

Auf Anfrage lieferbar:
 Ausführungen in Stahl A2 und A4
 Anschlussgewinde Pg und NPT
 Mit FPM-Dichteinsätzen für hohe Temperaturen
 Mit F-Dichteinsätzen nach EN 45545

Available on request:
 Versions in A2 or A4 steel
 Entry thread Pg or NPT
 With FPM sealing inserts for high temperatures
 With sealing inserts of type F in accordance with EN 45545



Mit Standard Bohrungen
 With standard hole layouts



Mit individuellen Bohrungen
 With customized hole layouts

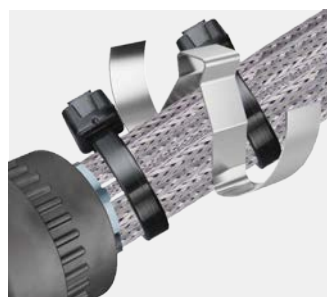
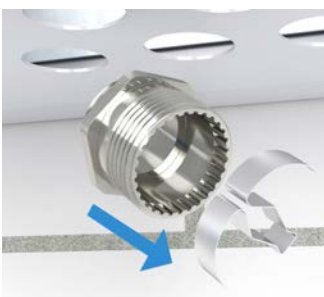

Kabelverschraubungen Progress® EMV easyCONNECT Messing mit Kontaktfeder Cable glands Progress® EMC easyCONNECT nickel-plated brass with contact spring

Kurzes Anschlussgewinde metrisch | Short entry thread metric

Material:	Messing vernickelt	Material:	Nickel-plated brass
Kontaktfeder:	Federstahl 1.4310	Contact spring:	Spring steel 1.4310
Dichtung:	TPE	Seal:	TPE
O-Ring:	NBR	O-ring:	NBR
Zugentlastung:	Ausführung A nach EN 62444	Strain relief:	Version A acc. to EN 62444
Schutzart:	IP 68 (bis 10 bar) / IP 69	Protection class:	IP 68 (up to 10 bar) / IP 69
NEMA Type rating:	4X	NEMA Type rating:	4X
Eigenschaften:	Für zeitsparende und sichere Montage von partiell abisolierten sowie durchgehend geschirmten Kabeln	Properties:	For a quick and safe installation of partially dismantled cables as well as thoroughly shielded cables
Einsatztemperatur:	-60 °C / +100 °C	Operation temperature:	-60 °C / +100 °C

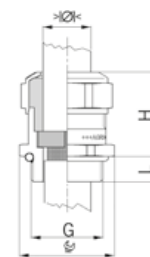

Zweiteiliger Dichteinsatz
nicht durchgehend isolierend

Two-piece sealing insert
not overall length insulated

G	>Ø< min mm	>Ø< max mm	>Ø< min mm	>Ø< max mm	H mm	L mm	i info	Art.-No.	
M12x1.5	-	-	3.5	5.0	15	22	5	1083.12.050	50
M12x1.5	-	-	5.0	6.5	15	22	5	1083.12.065	50
M16x1.5	6.0	8.0	8.0	10.5	18	25	5	1083.17	50
M20x1.5	8.0	11.0	11.0	15.0	24	27	6	1083.20	50
M25x1.5	12.5	16.0	16.0	20.5	30	33	7	1083.25	25
M32x1.5	17.0	21.0	21.0	25.5	36	33	8	1083.32	25
M40x1.5	24.0	28.5	28.5	33.0	46	38	8	1083.40	10
M50x1.5	33.0	37.0	37.0	42.0	55	42	9	1083.50	10
M63x1.5	40.0	46.0	46.0	52.0	70	42	10	1083.63	5

1 = Einteiliger Dichteinsatz

1 = One-piece sealing insert

Erhältlich mit Dichteinsatz gemäss EN 45545 / NFPA 130. Bei Anfragen oder Bestellung bitte ein F vor die Artikelnummer setzen.

Available with sealing inserts conformity with EN 45545 / NFPA 130. When placing an inquiry, prefix the article number by the capital F.

Auf Anfrage lieferbar:

Available on request:

Anschlussgewinde Pg und NPT

Entry thread Pg and NPT

Ausführungen in Stahl A2 und A4

Executions in steel A2 and A4



Progress
EMV easyCONNECT



Langes Anschlussgewinde metrisch | Long entry thread metric

Zweiteiliger Dichteinsatz
nicht durchgehend isolierend

Two-piece sealing insert
not overall length insulated

G	>Ø< min mm	>Ø< max mm	>Ø< min mm	>Ø< max mm	H mm	L mm	i info	Art.-No.	
M12x1.5	-	-	3.5	5.0	15	22	10	1183.12.050	50
M12x1.5	-	-	5.0	6.5	15	22	10	1183.12.065	50
M16x1.5	6.0	8.0	8.0	10.5	18	25	10	1183.17	50
M20x1.5	8.0	11.0	11.0	15.0	24	27	10	1183.20	50
M25x1.5	12.5	16.0	16.0	20.5	30	33	11	1183.25	25
M32x1.5	17.0	21.0	21.0	25.5	36	33	13	1183.32	25
M40x1.5	24.0	28.5	28.5	33.0	46	38	13	1183.40	10
M50x1.5	33.0	37.0	37.0	42.0	55	42	14	1183.50	10
M63x1.5	40.0	46.0	46.0	52.0	70	42	14	1183.63	5

1 = Einteiliger Dichteinsatz

1 = One-piece sealing insert

Erhältlich mit Dichteinsatz gemäss EN 45545 / NFPA 130. Bei Anfragen oder Bestellung bitte ein F vor die Artikelnummer setzen.

Available with sealing inserts conformity with EN 45545 / NFPA 130. When placing an inquiry, prefix the article number by the capital F.

Auf Anfrage lieferbar:

Available on request:

Anschlussgewinde Pg und NPT

Entry thread Pg and NPT

Ausführungen in Stahl A2 und A4

Executions in steel A2 and A4



Progress
EMV easyCONNECT



Kabelverschraubungen Progress® EMV Rapid Messing mit Kontaktscheibe

Cable glands Progress® EMC Rapid nickel-plated brass with contact disc

Kurzes Anschlussgewinde metrisch | Short entry thread metric

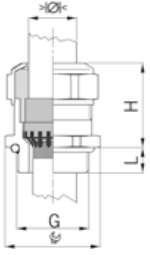

Material: Messing vernickelt
 Kontakthülse: Messing vernickelt
 Kontaktscheibe: Rostfreier Stahl A2
 Dichtung: TPE
 O-Ring: NBR
 Zugentlastung: Ausführung A nach EN 62444
 Schutzart: IP 68 (bis 10 bar) / IP 69
 NEMA Type rating: 4X
 Eigenschaften: Für zeitsparende Montage von partiell abisolierten sowie durchgehend geschirmten Kabeln
 Einsatztemperatur: -40 °C / +100 °C

Material: Nickel-plated brass
 Contact sleeve: Nickel-plated brass
 Contact disc: Stainless steel A2
 Seal: TPE
 O-ring: NBR
 Strain relief: Version A acc. to EN 62444
 Protection class: IP 68 (up to 10 bar) / IP 69
 NEMA Type rating: 4X
 Properties: For a quick installation of partially dismantled cables as well as thoroughly shielded cables
 Operation temperature: -40 °C / +100 °C



Progress
MS EMV Rapid



Einteiliger Dichteinsatz
nicht durchgehend isolierend

One-piece sealing insert
not overall length insulated

G	>Ø< min mm	>Ø< max mm	Ø mm	H mm	L mm	Art.-No.	
M12x1.5	4.5	6.0	15	20	5	1081.12.060	50
M12x1.5	6.0	7.5	15	20	5	1081.12.075	50
M16x1.5	6.0	8.0	18	23	5	1081.17.080	50
M16x1.5	8.0	10.0	18	25	5	1081.17.100	50
M20x1.5	8.0	11.0	24	25	6	1081.20.110	50
M20x1.5	11.0	14.0	24	27	6	1081.20.140	50
M25x1.5	13.0	16.0	30	30	7	1081.25.160	25
M25x1.5	16.0	19.0	30	33	7	1081.25.190	25
M32x1.5	18.0	21.0	36	32	8	1081.32.210	25
M32x1.5	21.0	25.0	36	32	8	1081.32.250	25

Langes Anschlussgewinde metrisch | Long entry thread metric



Progress
MS EMV Rapid



Einteiliger Dichteinsatz
nicht durchgehend isolierend

One-piece sealing insert
not overall length insulated

G	>Ø< min mm	>Ø< max mm	Ø mm	H mm	L mm	Art.-No.	
M12x1.5	4.5	6.0	15	20	10	1181.12.060	50
M12x1.5	6.0	7.5	15	20	10	1181.12.075	50
M16x1.5	6.0	8.0	18	23	10	1181.17.080	50
M16x1.5	8.0	10.0	18	25	10	1181.17.100	50
M20x1.5	8.0	11.0	24	25	10	1181.20.110	50
M20x1.5	11.0	14.0	24	27	10	1181.20.140	50
M25x1.5	13.0	16.0	30	30	11	1181.25.160	25
M25x1.5	16.0	19.0	30	33	11	1181.25.190	25
M32x1.5	18.0	21.0	36	32	13	1181.32.210	25
M32x1.5	21.0	25.0	36	32	13	1181.32.250	25

Kabelverschraubungen Progress® EMV Rapid Messing mit Kontaktscheibe

Cable glands Progress® EMC Rapid nickel-plated brass with contact disc

Kurzes Anschlussgewinde Pg | Short entry thread Pg

Material: Messing vernickelt
 Kontakthülse: Messing vernickelt
 Kontaktscheibe: Rostfreier Stahl A2
 Dichtung: TPE
 O-Ring: NBR
 Schutzart: IP 68 (bis 10 bar) / IP 69
 NEMA Type rating: 4X
 Eigenschaften: Für zeitsparende Montage von partiell abisolierten sowie durchgehend geschirmten Kabeln
 Einsatztemperatur: -40 °C / +100 °C

Material: Nickel-plated brass
 Contact sleeve: Nickel-plated brass
 Contact disc: Stainless steel A2
 Seal: TPE
 O-ring: NBR
 Protection class: IP 68 (up to 10 bar) / IP 69
 NEMA Type rating: 4X
 Properties: For a quick installation of partially dismantled cables as well as thoroughly shielded cables
 Operation temperature: -40 °C / +100 °C

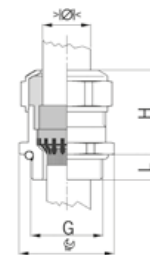

Einteiliger Dichteinsatz
 nicht durchgehend isolierend

One-piece sealing insert
 not overall length insulated

G	> Ø <	> Ø <	⊕	H	L	Art.-No.	
	min mm	max mm	mm	mm	mm		
Pg 7	4.5	6.0	15	20	6	1081.07.060	50
Pg 7	6.0	7.5	15	20	6	1081.07.075	50
Pg 9	6.0	8.0	18	23	6	1081.09.080	50
Pg 9	8.0	10.0	18	25	6	1081.09.100	50
Pg 11	5.5	8.5	21	25	6	1081.11.085	50
Pg 11	8.5	12.0	21	25	6	1081.11.120	50
Pg 13	8.0	11.0	24	25	6	1081.13.110	50
Pg 13	11.0	14.0	24	27	6	1081.13.140	50
Pg 16	8.0	11.0	24	24	6	1081.16.110	50
Pg 16	11.0	14.0	24	27	6	1081.16.140	50
Pg 21	13.0	16.0	30	30	7	1081.21.160	25
Pg 21	16.0	19.0	30	33	7	1081.21.190	25
Pg 29	19.0	23.0	38	33	8	1081.29.230	25
Pg 29	23.0	25.5	38	32	8	1081.29.255	25



Progress
 MS EMV Rapid



Langes Anschlussgewinde Pg | Long entry thread Pg

Einteiliger Dichteinsatz
 nicht durchgehend isolierend

One-piece sealing insert
 not overall length insulated

G	> Ø <	> Ø <	⊕	H	L	Art.-No.	
	min mm	max mm	mm	mm	mm		
Pg 7	4.5	6.0	15	20	10	1181.07.060	50
Pg 7	6.0	7.5	15	20	10	1181.07.075	50
Pg 9	6.0	8.0	18	23	10	1181.09.080	50
Pg 9	8.0	10.0	18	25	10	1181.09.100	50
Pg 11	5.5	8.5	21	25	10	1181.11.085	50
Pg 11	8.5	12.0	21	25	10	1181.11.120	50
Pg 13	8.0	11.0	24	25	10	1181.13.110	50
Pg 13	11.0	14.0	24	27	10	1181.13.140	50
Pg 16	8.0	11.0	24	24	10	1181.16.110	50
Pg 16	11.0	14.0	24	27	10	1181.16.140	50
Pg 21	13.0	16.0	30	30	12	1181.21.160	25
Pg 21	16.0	19.0	30	33	12	1181.21.190	25
Pg 29	19.0	23.0	38	33	12	1181.29.230	25
Pg 29	23.0	25.5	38	32	12	1181.29.255	25



Progress
 MS EMV Rapid



Kabelverschraubungen Progress® EMV Messing mit Kontakthülse

Cable glands Progress® EMC nickel-plated brass with contact sleeve

Kurzes Anschlussgewinde metrisch | Short entry thread metric

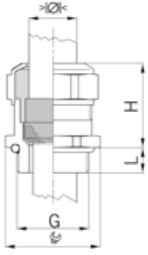

Material: Messing vernickelt
 Kontakthülse: Messing vernickelt
 Dichtung: TPE
 O-Ring: NBR
 Zugentlastung: Ausführung A nach EN 62444
 Schutzart: IP 68 (bis 10 bar) / IP 69
 NEMA Type rating: 4X
 Eigenschaften: Sehr guter Schirmkontakt über die Kontakthülse bei in der Kabelverschraubung endendem Schirmgeflecht

Material: Nickel-plated brass
 Contact sleeve: Nickel-plated brass
 Seal: TPE
 O-ring: NBR
 Strain relief: Version A acc. to EN 62444
 Protection class: IP 68 (up to 10 bar) / IP 69
 NEMA Type rating: 4X
 Properties: Excellent shield contact through the contact sleeve with the braided shield terminating in the screwed cable gland

Einsatztemperatur: -40 °C / +100 °C

Operation temperature: -40 °C / +100 °C



Progress MS EMV



Einteiliger Dichteinsatz
 nicht durchgehend isolierend

One-piece sealing insert
 not overall length insulated

G	>Ø< min mm	>Ø< max mm	mm	H mm	L mm	i info	Art.-No.	
M8x1.25	2.5	3.5	11	15	5	1	1080.08.035	50
M8x1.25	3.0	4.0	11	15	5	1	1080.08.040	50
M10x1.5	3.0	4.0	13	16	5	1	1080.10.040	50
M10x1.5	4.0	6.0	13	16	5	1	1080.10.060	50
M12x1.5	4.5	6.0	15	20	5	-	1080.12.060	50
M12x1.5	6.0	7.5	15	20	5	-	1080.12.075	50
M16x1.5	6.0	8.0	18	23	5	-	1080.17.080	50
M16x1.5	8.0	10.0	18	25	5	-	1080.17.100	50
M20x1.5	8.0	11.0	24	25	6	-	1080.20.110	50
M20x1.5	11.0	14.0	24	27	6	-	1080.20.140	50
M25x1.5	13.0	16.0	30	30	7	-	1080.25.160	25
M25x1.5	16.0	19.0	30	33	7	-	1080.25.190	25
M32x1.5	18.0	21.0	36	32	8	-	1080.32.210	25
M32x1.5	21.0	25.0	36	32	8	-	1080.32.250	25
M40x1.5	24.0	28.5	46	34	8	-	1080.40.285	10
M40x1.5	28.5	32.0	46	34	8	-	1080.40.320	10
M50x1.5	33.0	37.0	55	36	9	-	1080.50.370	10
M50x1.5	37.0	41.0	55	36	9	-	1080.50.410	10
M63x1.5	40.0	46.0	70	39	10	-	1080.63.460	5
M63x1.5	46.0	50.0	70	39	10	-	1080.63.500	5
M75x1.5	50.0	56.0	80	40	11	-	1080.75.560	1
M80x2.0	56.0	65.0	95	45	18	-	1080.80.650	1
M85x2.0	63.0	70.0	95	45	18	-	1080.85.700	1
M95x2.0	68.0	75.0	110	52	20	-	1080.95.750	1

1 = Metrisches Regelgewinde (mit VDE Testreport)

1 = Metric coarse-pitch thread (with VDE test report)

Erhältlich mit Dichteinsatz gemäss EN 45545 / NFPA 130. Bei Anfragen oder Bestellung bitte ein F vor die Artikelnummer setzen.

Available with sealing inserts conformity with EN 45545 / NFPA 130. When placing an inquiry, prefix the article number by the capital F.

Kabelverschraubungen Progress® EMV Messing mit Kontakthülse

Cable glands Progress® EMC nickel-plated brass with contact sleeve

Langes Anschlussgewinde metrisch | Long entry thread metric

Material:	Messing vernickelt	Material:	Nickel-plated brass
Kontakthülse:	Messing vernickelt	Contact sleeve:	Nickel-plated brass
Dichtung:	TPE	Seal:	TPE
O-Ring:	NBR	O-ring:	NBR
Zugentlastung:	Ausführung A nach EN 62444	Strain relief:	Version A acc. to EN 62444
Schutzart:	IP 68 (bis 10 bar) / IP 69	Protection class:	IP 68 (up to 10 bar) / IP 69
NEMA Type rating:	4X	NEMA Type rating:	4X
Eigenschaften:	Sehr guter Schirmkontakt über die Kontakthülse bei in der Kabelverschraubung endendem Schirmgeflecht	Properties:	Excellent shield contact through the contact sleeve with the braided shield terminating in the screwed cable gland
Einsatztemperatur:	-40 °C / +100 °C	Operation temperature:	-40 °C / +100 °C

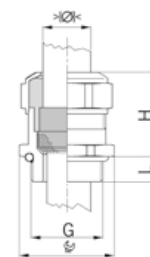

Einteiliger Dichteinsatz nicht durchgehend isolierend		One-piece sealing insert not overall length insulated						
G	>Ø< min mm	>Ø< max mm	H	L	i	Art.-No.		
			mm	mm	mm		info	
M8x1.25	2.5	3.5	11	15	10	1	1180.08.035	50
M8x1.25	3.0	4.0	11	15	10	1	1180.08.040	50
M10x1.5	3.0	4.0	13	16	10	1	1180.10.040	50
M10x1.5	4.0	6.0	13	16	10	1	1180.10.060	50
M12x1.5	4.5	6.0	15	20	10	-	1180.12.060	50
M12x1.5	6.0	7.5	15	20	10	-	1180.12.075	50
M16x1.5	6.0	8.0	18	23	10	-	1180.17.080	50
M16x1.5	8.0	10.0	18	25	10	-	1180.17.100	50
M20x1.5	8.0	11.0	24	25	10	-	1180.20.110	50
M20x1.5	11.0	14.0	24	27	10	-	1180.20.140	50
M25x1.5	13.0	16.0	30	30	11	-	1180.25.160	25
M25x1.5	16.0	19.0	30	33	11	-	1180.25.190	25
M32x1.5	18.0	21.0	36	32	13	-	1180.32.210	25
M32x1.5	21.0	25.0	36	32	13	-	1180.32.250	25
M40x1.5	24.0	28.5	46	34	13	-	1180.40.285	10
M40x1.5	28.5	32.0	46	34	13	-	1180.40.320	10
M50x1.5	33.0	37.0	55	36	14	-	1180.50.370	10
M50x1.5	37.0	41.0	55	36	14	-	1180.50.410	10
M63x1.5	40.0	46.0	70	39	14	-	1180.63.460	5
M63x1.5	46.0	50.0	70	39	14	-	1180.63.500	5



Progress MS EMV



1 = Metrisches Regelgewinde (mit VDE Testreport)

1 = Metric coarse-pitch thread (with VDE test report)

Erhältlich mit Dichteinsatz gemäss EN 45545 / NFPA 130. Bei Anfragen oder Bestellung bitte ein F vor die Artikelnummer setzen.

Available with sealing inserts conformity with EN 45545 / NFPA 130. When placing an inquiry, prefix the article number by the capital F.

Kabelverschraubungen Progress® EMV Messing mit Kontakthülse

Cable glands Progress® EMC nickel-plated brass with contact sleeve

Kurzes Anschlussgewinde Pg | Short entry thread Pg

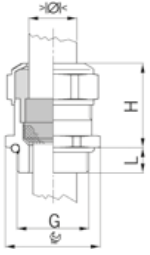

Material: Messing vernickelt
 Kontakthülse: Messing vernickelt
 Dichtung: TPE
 O-Ring: NBR
 Schutzart: IP 68 (bis 10 bar) / IP 69
 NEMA Type rating: 4X
 Eigenschaften: Sehr guter Schirmkontakt über die Kontakthülse bei in der Kabelverschraubung endendem Schirmgeflecht

Material: Nickel-plated brass
 Contact sleeve: Nickel-plated brass
 Seal: TPE
 O-ring: NBR
 Protection class: IP 68 (up to 10 bar) / IP 69
 NEMA Type rating: 4X
 Properties: Excellent shield contact through the contact sleeve with the braided shield terminating in the screwed cable gland

Einsatztemperatur: -40 °C / +100 °C

Operation temperature: -40 °C / +100 °C



Progress MS EMV



Einteiliger Dichteinsatz
 nicht durchgehend isolierend

One-piece sealing insert
 not overall length insulated

G	>∅<	>∅<	∅	H	L	Art.-No.	
	min mm	max mm	mm	mm	mm		
Pg 7	4.5	6.0	15	20	6	1080.07.060	50
Pg 7	6.0	7.5	15	20	6	1080.07.075	50
Pg 9	6.0	8.0	18	23	6	1080.09.080	50
Pg 9	8.0	10.0	18	25	6	1080.09.100	50
Pg 11	5.5	8.5	21	23	6	1080.11.085	50
Pg 11	8.5	12.0	21	23	6	1080.11.120	50
Pg 13	8.0	11.0	24	25	6	1080.13.110	50
Pg 13	11.0	14.0	24	27	6	1080.13.140	50
Pg 16	8.0	11.0	24	24	6	1080.16.110	50
Pg 16	11.0	14.0	24	27	6	1080.16.140	50
Pg 21	13.0	16.0	30	30	7.5	1080.21.160	25
Pg 21	16.0	19.0	30	33	7.5	1080.21.190	25
Pg 29	19.0	23.0	38	33	8	1080.29.230	25
Pg 29	23.0	25.5	38	32	8	1080.29.255	25
Pg 36	25.0	30.5	50	36	8	1080.36.305	10
Pg 36	30.5	35.0	50	34	8	1080.36.350	10
Pg 42	33.0	37.0	55	37	10	1080.42.370	10
Pg 42	37.0	41.0	55	36	10	1080.42.410	10
Pg 48	39.0	43.0	65	42	11	1080.48.430	10
Pg 48	43.0	46.5	65	40	11	1080.48.465	10

Erhältlich mit Dichteinsatz gemäss EN 45545 / NFPA 130.
 Bei Anfragen oder Bestellung bitte ein F vor die Artikelnummer setzen.

Available with sealing inserts conformity with EN 45545 / NFPA 130. When placing an inquiry, prefix the article number by the capital F.

Kabelverschraubungen Progress® EMV Messing mit Kontakthülse Cable glands Progress® EMC nickel-plated brass with contact sleeve

Langes Anschlussgewinde Pg | Long entry thread Pg

Material: Messing vernickelt
 Kontakthülse: Messing vernickelt
 Dichtung: TPE
 O-Ring: NBR
 Schutzart: IP 68 (bis 10 bar) / IP 69
 NEMA Type rating: 4X
 Eigenschaften: Sehr guter Schirmkontakt über die Kontakthülse bei in der Kabelverschraubung endendem Schirmgeflecht

Material: Nickel-plated brass
 Contact sleeve: Nickel-plated brass
 Seal: TPE
 O-ring: NBR
 Protection class: IP 68 (up to 10 bar) / IP 69
 NEMA Type rating: 4X
 Properties: Excellent shield contact through the contact sleeve with the braided shield terminating in the screwed cable gland

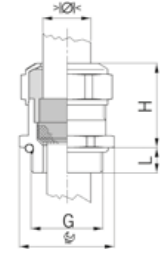

Einsatztemperatur: -40 °C / +100 °C

Operation temperature: -40 °C / +100 °C

Einteiliger Dichteinsatz
nicht durchgehend isolierend

One-piece sealing insert
not overall length insulated

G	> <	> <	⌀	H	L	Art.-No.	
	min mm	max mm	mm	mm	mm		
Pg 7	4.5	6.0	15	20	10	1180.07.060	50
Pg 7	6.0	7.5	15	20	10	1180.07.075	50
Pg 9	6.0	8.0	18	23	10	1180.09.080	50
Pg 9	8.0	10.0	18	25	10	1180.09.100	50
Pg 11	5.5	8.5	21	23	10	1180.11.085	50
Pg 11	8.5	12.0	21	23	10	1180.11.120	50
Pg 13	8.0	11.0	24	25	10	1180.13.110	50
Pg 13	11.0	14.0	24	27	10	1180.13.140	50
Pg 16	8.0	11.0	24	24	10	1180.16.110	50
Pg 16	11.0	14.0	24	27	10	1180.16.140	50
Pg 21	13.0	16.0	30	30	12	1180.21.160	25
Pg 21	16.0	19.0	30	33	12	1180.21.190	25
Pg 29	19.0	23.0	38	33	12	1180.29.230	25
Pg 29	23.0	25.5	38	32	12	1180.29.255	25
Pg 36	25.0	30.5	50	36	15	1180.36.305	10
Pg 36	30.5	35.0	50	34	15	1180.36.350	10
Pg 42	33.0	37.0	55	37	15	1180.42.370	10
Pg 42	37.0	41.0	55	36	15	1180.42.410	10
Pg 48	39.0	43.0	65	42	15	1180.48.430	10
Pg 48	43.0	46.5	65	40	15	1180.48.465	10

Erhältlich mit Dichteinsatz gemäss EN 45545 / NFPA 130. Bei Anfragen oder Bestellung bitte ein F vor die Artikelnummer setzen.

Available with sealing inserts conformity with EN 45545 / NFPA 130. When placing an inquiry, prefix the article number by the capital F.



Progress MS EMV



Kurzes Anschlussgewinde metrisch | Short entry thread metric

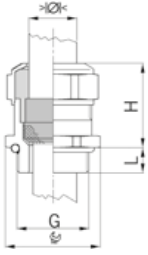

Material:	Messing vernickelt	Material:	Nickel-plated brass
Kontakthülse:	Messing vernickelt	Contact sleeve:	Nickel-plated brass
Dichtung:	FPM	Seal:	FPM
O-Ring:	FPM	O-ring:	FPM
Zugentlastung:	Ausführung A nach EN 62444	Strain relief:	Version A acc. to EN 62444
Schutzart:	IP 68 (bis 10 bar) / IP 69	Protection class:	IP 68 (up to 10 bar) / IP 69
Eigenschaften:	Sehr guter Schirmkontakt über die Kontakthülse bei in der Kabelverschraubung endendem Schirmgeflecht	Properties:	Excellent shield contact through the contact sleeve with the braided shield terminating in the screwed cable gland
Einsatztemperatur:	-40 °C / +200 °C	Operation temperature:	-40 °C / +200 °C



Einteiliger Dichteinsatz
nicht durchgehend isolierend

One-piece sealing insert
not overall length insulated

G	>Ø< min mm	>Ø< max mm	Ø _{br} mm	H mm	L mm	i info	Art.-No.	
M10x1.5	3.0	4.0	13	16	5	1	1080.10.91.040	50
M10x1.5	4.0	6.0	13	16	5	1	1080.10.91.060	50
M12x1.5	4.5	6.0	15	20	5	-	1080.12.91.060	50
M12x1.5	6.0	7.5	15	20	5	-	1080.12.91.075	50
M16x1.5	6.0	8.0	18	23	5	-	1080.17.91.080	50
M16x1.5	8.0	10.0	18	25	5	-	1080.17.91.100	50
M20x1.5	8.0	11.0	24	25	6	-	1080.20.91.110	50
M20x1.5	11.0	14.0	24	27	6	-	1080.20.91.140	50
M25x1.5	13.0	16.0	30	30	7	-	1080.25.91.160	25
M25x1.5	16.0	19.0	30	33	7	-	1080.25.91.190	25
M32x1.5	18.0	21.0	36	32	8	-	1080.32.91.210	25
M32x1.5	21.0	25.0	36	32	8	-	1080.32.91.250	25

1 = Metrisches Regelgewinde

1 = Metric coarse-pitch thread

Langes Anschlussgewinde metrisch | Long entry thread metric



Einteiliger Dichteinsatz
nicht durchgehend isolierend

One-piece sealing insert
not overall length insulated

G	>Ø< min mm	>Ø< max mm	Ø _{br} mm	H mm	L mm	i info	Art.-No.	
M10x1.5	3.0	4.0	13	16	10	1	1180.10.91.040	50
M10x1.5	4.0	6.0	13	16	10	1	1180.10.91.060	50
M12x1.5	4.5	6.0	15	20	10	-	1180.12.91.060	50
M12x1.5	6.0	7.5	15	20	10	-	1180.12.91.075	50
M16x1.5	6.0	8.0	18	23	10	-	1180.17.91.080	50
M16x1.5	8.0	10.0	18	25	10	-	1180.17.91.100	50
M20x1.5	8.0	11.0	24	25	10	-	1180.20.91.110	50
M20x1.5	11.0	14.0	24	27	10	-	1180.20.91.140	50
M25x1.5	13.0	16.0	30	30	11	-	1180.25.91.160	25
M25x1.5	16.0	19.0	30	33	11	-	1180.25.91.190	25
M32x1.5	18.0	21.0	36	32	13	-	1180.32.91.210	25
M32x1.5	21.0	25.0	36	32	13	-	1180.32.91.250	25

1 = Metrisches Regelgewinde

1 = Metric coarse-pitch thread

Kurzes Anschlussgewinde Pg | Short entry thread Pg

Material: Messing vernickelt
 Kontakthülse: Messing vernickelt
 Dichtung: FPM
 O-Ring: FPM
 Schutzart: IP 68 (bis 10 bar) / IP 69
 Eigenschaften: Sehr guter Schirmkontakt über die Kontakthülse bei in der Kabelverschraubung endendem Schirmgeflecht

Material: Nickel-plated brass
 Contact sleeve: Nickel-plated brass
 Seal: FPM
 O-ring: FPM
 Protection class: IP 68 (up to 10 bar) / IP 69
 Properties: Excellent shield contact through the contact sleeve with the braided shield terminating in the screwed cable gland

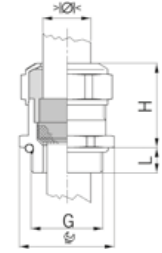

Einsatztemperatur: -40 °C / +200 °C

Operation temperature: -40 °C / +200 °C

Einteiliger Dichteinsatz
 nicht durchgehend isolierend

One-piece sealing insert
 not overall length insulated

G	> Ø <	> Ø <	Ø	H	L	Art.-No.	
	min mm	max mm	mm	mm	mm		
Pg 9	6.0	8.0	18	23	6	1080.09.91.080	50
Pg 9	8.0	10.0	18	25	6	1080.09.91.100	50
Pg 11	5.5	8.5	21	23	6	1080.11.91.085	50
Pg 11	8.5	12.0	21	23	6	1080.11.91.120	50
Pg 13	8.0	11.0	24	25	6	1080.13.91.110	50
Pg 13	11.0	14.0	24	27	6	1080.13.91.140	50
Pg 16	8.0	11.0	24	24	6	1080.16.91.110	50
Pg 16	11.0	14.0	24	27	6	1080.16.91.140	50
Pg 21	13.0	16.0	30	30	7.5	1080.21.91.160	25
Pg 21	16.0	19.0	30	33	7.5	1080.21.91.190	25
Pg 29	19.0	23.0	38	33	8	1080.29.91.230	25
Pg 29	23.0	25.5	38	32	8	1080.29.91.255	25



Langes Anschlussgewinde Pg | Long entry thread Pg

Einteiliger Dichteinsatz
 nicht durchgehend isolierend

One-piece sealing insert
 not overall length insulated

G	> Ø <	> Ø <	Ø	H	L	Art.-No.	
	min mm	max mm	mm	mm	mm		
Pg 9	6.0	8.0	18	23	10	1180.09.91.080	50
Pg 9	8.0	10.0	18	25	10	1180.09.91.100	50
Pg 11	5.5	8.5	21	23	10	1180.11.91.085	50
Pg 11	8.5	12.0	21	23	10	1180.11.91.120	50
Pg 13	8.0	11.0	24	25	10	1180.13.91.110	50
Pg 13	8.5	12.0	24	27	10	1180.13.91.140	50
Pg 16	8.0	11.0	24	24	10	1180.16.91.110	50
Pg 16	11.0	14.0	24	27	10	1180.16.91.140	50
Pg 21	13.0	16.0	30	30	12	1180.21.91.160	25
Pg 21	16.0	19.0	30	33	12	1180.21.91.190	25
Pg 29	19.0	23.0	38	33	12	1180.29.91.230	25
Pg 29	23.0	25.5	38	32	12	1180.29.91.255	25



Kabelverschraubungen Progress® EMV Messing mit Knickschutzfeder Cable glands Progress® EMC nickel-plated brass with antikink spring

Kurzes Anschlussgewinde metrisch | Short entry thread metric

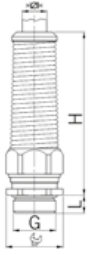

Material:	Messing vernickelt	Material:	Nickel-plated brass
Knickschutzfeder:	Rostfreier Stahl A2	Antikink spring:	Stainless steel A2
Dichtung:	TPE	Seal:	TPE
O-Ring:	NBR	O-ring:	NBR
Zugentlastung:	Ausführung A nach EN 62444	Strain relief:	Version A acc. to EN 62444
Schutzart:	IP 68 (bis 10 bar) / IP 69	Protection class:	IP 68 (up to 10 bar) / IP 69
Eigenschaften:	Sehr guter Schirmkontakt über die Kontakthülse bei in der Kabelverschraubung endendem Schirmgeflecht	Properties:	Excellent shield contact through the contact sleeve with the braided shield terminating in the screwed cable gland
Einsatztemperatur:	-40 °C / +100 °C	Operation temperature:	-40 °C / +100 °C



Progress
MS EMV FKN



Einteiliger Dichteinsatz
nicht durchgehend isolierend

One-piece sealing insert
not overall length insulated

G	>Ø< min mm	>Ø< max mm	Ø _{br} mm	H mm	L mm	i info	Art.-No.	
M8x1.25	2.5	3.5	11	50	5	1	1080.08.52.035	10
M8x1.25	3.0	4.0	11	50	5	1	1080.08.52.040	10
M10x1.5	3.0	4.0	13	54	5	1	1080.10.52.040	10
M10x1.5	4.0	6.0	13	54	5	1	1080.10.52.060	10
M12x1.5	4.5	6.0	15	60	5	-	1080.12.52.060	10
M12x1.5	6.0	7.5	15	60	5	-	1080.12.52.075	10
M16x1.5	6.0	8.0	18	69	5	-	1080.17.52.080	10
M16x1.5	8.0	10.0	18	69	5	-	1080.17.52.100	10
M20x1.5	8.0	11.0	24	88	6	-	1080.20.52.110	10
M20x1.5	11.0	14.0	24	88	6	-	1080.20.52.140	10
M25x1.5	13.0	16.0	30	104	7	-	1080.25.52.160	10
M25x1.5	16.0	19.0	30	104	7	-	1080.25.52.190	10
M32x1.5	18.0	21.0	36	112	8	-	1080.32.52.210	5
M32x1.5	21.0	24.5	36	112	8	-	1080.32.52.245	5

1 = Metrisches Regelgewinde (mit VDE Testreport)

1 = Metric coarse-pitch thread (with VDE test report)

Erhältlich mit Dichteinsatz gemäss EN 45545 / NFPA 130.
Bei Anfragen oder Bestellung bitte ein F vor die Artikelnummer setzen.

Available with sealing inserts conformity with EN 45545 / NFPA 130. When placing an inquiry, prefix the article number by the capital F.

Auf Anfrage lieferbar:

Available on request:

Langes Anschlussgewinde

Long entry thread

Kabelverschraubungen Progress® EMV Messing mit Knickschutzfeder Cable glands Progress® EMC nickel-plated brass with antikink spring

Kurzes Anschlussgewinde Pg | Short entry thread Pg

Material: Messing vernickelt
Knickschutzfeder: Rostfreier Stahl A2
Dichtung: TPE
O-Ring: NBR
Schutzart: IP 68 (bis 10 bar) / IP 69
Eigenschaften: Sehr guter Schirmkontakt über die Kontakthülse bei in der Kabelverschraubung endendem Schirmgeflecht

Material: Nickel-plated brass
Antikink spring: Stainless steel A2
Seal: TPE
O-ring: NBR
Protection class: IP 68 (up to 10 bar) / IP 69
Properties: Excellent shield contact through the contact sleeve with the braided shield terminating in the screwed cable gland

Einsatztemperatur: -40 °C / +100 °C

Operation temperature: -40 °C / +100 °C

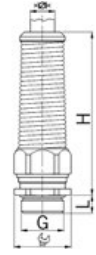

Einteiliger Dichteinsatz
nicht durchgehend isolierend

One-piece sealing insert
not overall length insulated

G	Ø		mm	H	L	Art.-No.	mm
	min mm	max mm					
Pg 7	4.5	6.0	15	60	6	1080.07.52.060	10
Pg 7	6.0	7.5	15	60	6	1080.07.52.075	10
Pg 9	6.0	8.0	18	69	6	1080.09.52.080	10
Pg 9	8.0	10.0	18	69	6	1080.09.52.100	10
Pg 11	6.0	8.0	18/21	69	6	1080.11.52.080	10
Pg 11	8.0	10.0	18/21	69	6	1080.11.52.100	10
Pg 13	8.0	11.0	24	88	6	1080.13.52.110	10
Pg 13	11.0	14.0	24	88	6	1080.13.52.140	10
Pg 16	8.0	11.0	24	88	6	1080.16.52.110	10
Pg 16	11.0	14.0	24	88	6	1080.16.52.140	10
Pg 21	13.0	16.0	30	104	7	1080.21.52.160	5
Pg 21	16.0	19.0	30	104	7	1080.21.52.190	5

Erhältlich mit Dichteinsatz gemäss EN 45545 / NFPA 130. Bei Anfragen oder Bestellung bitte ein F vor die Artikelnummer setzen.

Available with sealing inserts conformity with EN 45545 / NFPA 130. When placing an inquiry, prefix the article number by the capital F.

Auf Anfrage lieferbar:

Available on request:

Langes Anschlussgewinde

Long entry thread



Kabelverschraubungen Progress® EMV powerCONNECT Messing Cable glands Progress® EMC powerCONNECT nickel-plated brass

Kurzes Anschlussgewinde metrisch | Short entry thread metric

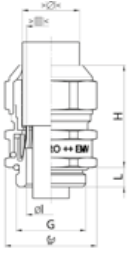

Material: Messing vernickelt
 Dichtung: TPE
 O-Ring: NBR
 Zugentlastung: Ausführung A nach EN 62444
 Schutzart: IP 68 (bis 10 bar) / IP 69
 NEMA Type rating: 4X
 Eigenschaften: Für hohe Ableitströme, konzentrische Schirmkontaktierung 360° mit tiefstem Übergangswiderstand und Transferimpedanz. Sehr geringe Bauhöhe.
 Einsatztemperatur: -60 °C / +100 °C

Material: Nickel-plated brass
 Seal: TPE
 O-ring: NBR
 Strain relief: Version A acc. to EN 62444
 Protection class: IP 68 (up to 10 bar) / IP 69
 NEMA Type rating: 4X
 Properties: For high leakage currents, concentric 360° shield contact ensure extremely low transfer resistance and transfer impedance. Compact design
 Operation temperature: -60 °C / +100 °C



Progress
EMV powerCONNECT



Zweiteiliger Dichteinsatz
nicht durchgehend isolierend

G	>∅< min mm	>∅< max mm	>∅< min mm	>∅< max mm	>■< mm	∅ mm	mm	H mm	L mm	i info	Art.-No.	
M16x1.5	6.0	8.0	8.0	10.5	9.3	8.2	18	28	5	-	1084.17	25
M20x1.5	8.0	11.0	11.0	15.0	13.4	11.9	24	32	6	-	1084.20	25
M25x1.5	12.5	16.0	16.0	20.5	18.7	17.6	30	36.5	7	-	1084.25	25
M32x1.5	17.0	21.0	21.0	25.5	23.8	22.1	36	38.5	8	-	1084.32	25
M40x1.5	24.0	28.5	28.5	33.0	30.4	29.5	46	42	8	-	1084.40	10
M50x1.5	33.0	37.0	37.0	42.0	38.7	37.7	55	44.5	9	-	1084.50	10
M63x1.5	40.0	46.0	46.0	52.0	48.6	46.6	70	49	10	-	1084.63	5
M75x1.5	50.0	56.0	56.0	63.0	59.7	57.9	80	51	11	-	1084.75	1
M80x2.0	-	-	58.0	65.0	62.0	59.8	95	58	12	1	1084.80.650	1
M85x2.0	-	-	63.0	70.0	67.0	64.7	95	58	12	1	1084.85.700	1

Two-piece sealing insert
not overall length insulated

1 = Einteiliger Dichteinsatz

Erhältlich mit Dichteinsatz gemäss EN 45545 / NFPA 130. Bei Anfragen oder Bestellung bitte ein F vor die Artikelnummer setzen.

Auf Anfrage lieferbar:

Rostfreier Stahl A2 oder A4

Anschlussgewinde Pg und NPT

1 = One-piece sealing insert

Available with sealing inserts conformity with EN 45545 / NFPA 130. When placing an inquiry, prefix the article number by the capital F.

Available on request:

Stainless steel A2 or A4

Entry thread Pg and NPT

Langes Anschlussgewinde metrisch | Long entry thread metric



Progress
EMV powerCONNECT



Zweiteiliger Dichteinsatz
nicht durchgehend isolierend

G	>∅< min mm	>∅< max mm	>∅< min mm	>∅< max mm	>■< mm	∅ mm	mm	H mm	L mm	i info	Art.-No.	
M16x1.5	6.0	8.0	8.0	10.5	9.3	8.2	18	28	10	-	1184.17	25
M20x1.5	8.0	11.0	11.0	15.0	13.4	11.9	24	32	10	-	1184.20	25
M25x1.5	12.5	16.0	16.0	20.5	18.7	17.6	30	36.5	11	-	1184.25	25
M32x1.5	17.0	21.0	21.0	25.5	23.8	22.1	36	38.5	13	-	1184.32	25
M40x1.5	24.0	28.5	28.5	33.0	30.4	29.5	46	42	13	-	1184.40	10
M50x1.5	33.0	37.0	37.0	42.0	38.7	37.7	55	44.5	14	-	1184.50	10
M63x1.5	40.0	46.0	46.0	52.0	48.6	46.6	70	49	14	-	1184.63	5
M75x1.5	50.0	56.0	56.0	63.0	59.7	57.9	80	51	15	-	1184.75	1
M80x2.0	-	-	58.0	65.0	62.0	59.8	95	58	18	1	1184.80.650	1
M85x2.0	-	-	63.0	70.0	67.0	64.7	95	58	18	1	1184.85.700	1

Two-piece sealing insert
not overall length insulated

1 = Einteiliger Dichteinsatz

Erhältlich mit Dichteinsatz gemäss EN 45545 / NFPA 130. Bei Anfragen oder Bestellung bitte ein F vor die Artikelnummer setzen.

Auf Anfrage lieferbar:

Rostfreier Stahl A2 oder A4

Anschlussgewinde Pg und NPT

1 = One-piece sealing insert

Available with sealing inserts conformity with EN 45545 / NFPA 130. When placing an inquiry, prefix the article number by the capital F.

Available on request:

Stainless steel A2 or A4

Entry thread Pg and NPT

Kabelverschraubungen Progress® EMV Serie 85 Messing mit Spannzange Cable glands Progress® EMC Series 85 nickel-plated brass with collet chuck

Anschlussgewinde metrisch | Entry thread metric

Material:	Messing vernickelt	Material:	Nickel-plated brass
Dichtung:	TPE	Seal:	TPE
O-Ring:	NBR	O-ring:	NBR
Zugentlastung:	Ausführung A nach EN 62444	Strain relief:	Version A acc. to EN 62444
Schutzart:	IP 68 (bis 10 bar) / IP 69	Protection class:	IP 68 (up to 10 bar) / IP 69
Eigenschaften:	Für hohe Ableitströme, konzentrische Schirmkontaktierung mit tiefsten Übergangswiderständen und Transferimpedanzen	Properties:	For high leakage currents, concentric shield contact with minimal transfer resistances and transfer impedances
Einsatztemperatur:	-40 °C / +100 °C	Operation temperature:	-40 °C / +100 °C

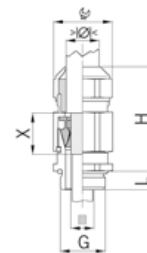

Zweiteiliger Dichteinsatz
nicht durchgehend isolierend

Two-piece sealing insert
not overall length insulated

G	Ø		Ø		mm	mm	mm	mm	mm	mm	mm	mm	Art.-No.	Cubes
	min	max	min	max										
M16x1.5	-	-	4.5	6.0	3.0-4.5	18	40	6	14	1000.17.85.045	25			
M16x1.5	6.0	8.0	8.0	10.5	4.5-8.0	18	42	8	16	1000.17.85.080	25			
M16x1.5	8.0	11.0	11.0	15.0	7.5-10.0	24	47	8	20	1000.17.85.100	25			
M20x1.5	8.0	11.0	11.0	15.0	7.5-12.0	24	47	8	20	1000.20.85.120	25			
M20x1.5	12.5	16.0	16.0	20.5	10.0-14.0	30	59	8	21	1000.20.85.140	20			
M25x1.5	12.5	16.0	16.0	20.5	10.0-16.0	30	59	8	21	1000.25.85.160	20			
M25x1.5	17.0	21.0	21.0	25.5	14.0-19.0	36	66	8	24	1000.25.85.190	25			
M32x1.5	17.0	21.0	21.0	25.5	14.0-22.0	36	66	10	24	1000.32.85.220	25			
M32x1.5	24.0	28.5	28.5	33.0	21.0-25.0	46	68	10	24	1000.32.85.250	5			
M40x1.5	24.0	28.5	28.5	33.0	21.0-30.0	46	68	12	24	1000.40.85.300	5			
M50x1.5	33.0	37.0	37.0	42.0	29.0-38.0	55	82	13	30	1000.50.85.380	5			
M63x1.5	33.0	37.0	37.0	42.0	29.0-38.0	70/55	82	15	30	1000.63.85.380	5			
M63x1.5	40.0	46.0	46.0	52.0	35.0-44.0	70	78	15	26	1000.63.85.440	1			



Progress
EMV Serie 85



Erhältlich mit Dichteinsatz gemäss EN 45545 / NFPA 130. Bei Anfragen oder Bestellung bitte ein F vor die Artikelnummer setzen.

Available with sealing inserts conformity with EN 45545 / NFPA 130. When placing an inquiry, prefix the article number by the capital F.

Wichtig: Um den Kabelschirm und die Kabellitzen optimal zu schützen ist es erforderlich, das der Kabelverschraubung beiliegende Kupfer-EMV-Tape zu montieren.

Important: To provide the best possible protection for the cable shield and the cable, it is necessary to install a copper EMC tape.

Das Kupfer-Tape muss zwingend gemäss Illustration montiert werden! (Beispiel: Tape Scotch 3M Typ 1181)

The copper tape must be fixed according to the illustration! (example: Tape Scotch 3M Typ 1181)

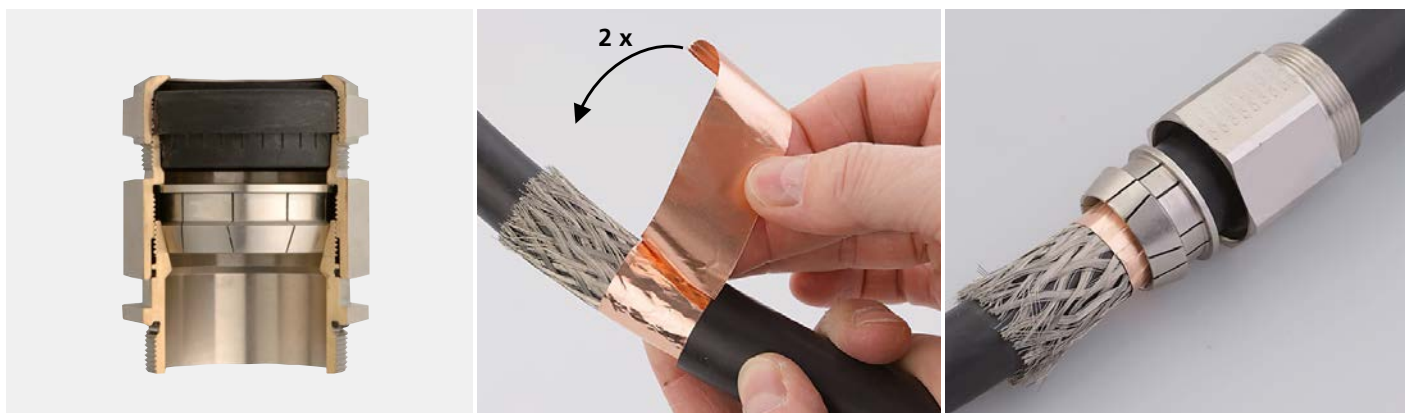

Kabelverschraubungen Progress® EMV Serie 85 Messing mit Spannzange

Cable glands Progress® EMC Series 85 nickel-plated brass with collet chuck

Anschlussgewinde Pg | Entry thread Pg

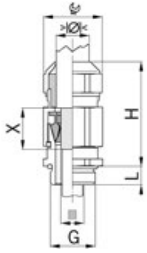



Material: Messing vernickelt
 Dichtung: TPE
 O-Ring: NBR
 Schutzart: IP 68 (bis 10 bar) / IP 69
 Eigenschaften: Für hohe Ableitströme, konzentrische Schirmkontaktierung mit tiefsten Übergangswiderständen und Transferimpedanzen
 Einsatztemperatur: -40 °C / +100 °C

Material: Nickel-plated brass
 Seal: TPE
 O-ring: NBR
 Protection class: IP 68 (up to 10 bar) / IP 69
 Properties: For high leakage currents, concentric shield contact with minimal transfer resistances and transfer impedances
 Operation temperature: -40 °C / +100 °C



Zweiteiliger Dichteinsatz
 nicht durchgehend isolierend

Two-piece sealing insert
 not overall length insulated

G	>∅<	>∅<	>∅<	>∅<	>■<		H	L	X	Art.-No.	
	min mm	max mm	min mm	max mm	mm	mm	mm	mm	mm		
Pg 11	6.0	8.0	8.0	10.5	4.5-8.0	21/18	42	8	16	1000.11.85.080	25
Pg 11	8.0	11.0	11.0	15.0	7.5-12.0	24	47	8	20	1000.11.85.120	25
Pg 16	8.0	11.0	11.0	15.0	7.5-12.0	24	47	8	20	1000.16.85.120	25
Pg 16	12.5	16.0	16.0	20.5	10.0-15.0	30	59	8	21	1000.16.85.150	25
Pg 21	12.5	16.0	16.0	20.5	10.0-16.0	30	59	8	21	1000.21.85.160	20
Pg 21	17.0	21.0	21.0	25.5	14.0-19.0	36	66	8	24	1000.21.85.190	25
Pg 29	17.0	21.0	21.0	25.5	14.0-22.0	38/36	66	10	24	1000.29.85.220	20
Pg 29	24.0	28.5	28.5	33.0	21.0-25.0	46	68	10	24	1000.29.85.250	5

Erhältlich mit Dichteinsatz gemäss EN 45545 / NFPA 130. Bei Anfragen oder Bestellung bitte ein F vor die Artikelnummer setzen.

Available with sealing inserts conformity with EN 45545 / NFPA 130. When placing an inquiry, prefix the article number by the capital F.

Wichtig: Um den Kabelschirm und die Kabellitzen optimal zu schützen ist es erforderlich, das der Kabelverschraubung beiliegende Kupfer-EMV-Tape zu montieren.

Important: To provide the best possible protection for the cable shield and the cable, it is necessary to install a copper EMC tape.

Weitere Abmessungen auf Anfrage

Further dimensions upon request

Das Kupfer-Tape muss zwingend gemäss Illustration montiert werden! (Beispiel: Tape Scotch 3M Typ 1181)

The copper tape must be fixed according to the illustration! (example: Tape Scotch 3M Typ 1181)

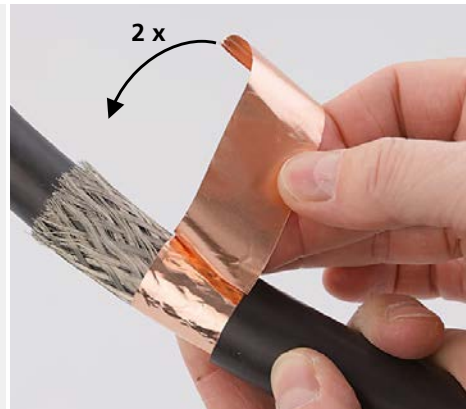

EMV-Gegenmutter Messing mit Schneidezähnen



EMC lock nuts nickel-plated brass with cutter teeth

Anschlussgewinde metrisch | Entry thread metric

Material: Messing vernickelt
 Ausführung: EMV-Gegenmutter mit Schneidezähnen für eine optimale Kontaktierung
 Einsatztemperatur: -60 °C / +200 °C

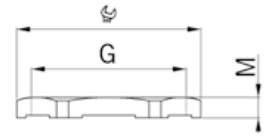
Material: Nickel-plated brass
 Execution: EMC lock nut with cutting teeth for optimised shield contact
 Operation temperature: -60 °C / +200 °C



G		M	i	Art.-No.	
	mm	mm	info		
M8x1.25	11	3.3	1	8008.85	25
M10x1.5	13	3.3	1	8010.85	25
M12x1.5	15	3.5	-	8012.85	25
M16x1.5	19	3.5	-	8017.85	25
M20x1.5	24	4.0	-	8020.85	25
M25x1.5	30	4.0	-	8025.85	10
M32x1.5	36	5.0	-	8032.85	10
M40x1.5	46	5.3	-	8040.85	10
M50x1.5	55	6.3	-	8050.85	10
M63x1.5	70	7.0	-	8063.85	10

1 = Metrisches Regelgewinde 1 = Metric coarse-pitch thread



Anschlussgewinde Pg | Entry thread Pg

G		M	Art.-No.	
	mm	mm		
Pg 7	15	3.3	8007.85	25
Pg 9	18	3.3	8009.85	25
Pg 11	21	3.5	8011.85	25
Pg 13	24	3.5	8013.85	25
Pg 16	26	3.5	8016.85	25
Pg 21	32	4.0	8021.85	10
Pg 29	41	4.6	8029.85	10
Pg 36	50	5.8	8036.85	10
Pg 42	60	5.8	8042.85	10
Pg 48	65	6.5	8048.85	10



Erdungslaschen zu Kabelverschraubungen

Grounding straps suitable for cable glands

passend zu Kabelverschraubungen Progress® | suitable for cable glands Progress®

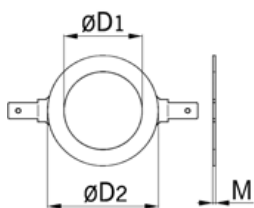

Material: Messing roh
 Einsatzbereich: Löt- oder steckbar
 6,3 x 1,0 mm
 Einsatztemperatur: -60 °C / +200 °C

Material: Brass raw
 Application: Solderable or pluggable
 6,3 x 1,0 mm
 Operation temperature: -60 °C / +200 °C



Erdungslaschen zu Kabelverschraubungen
 Anschlussgewinde metrisch

Grounding straps suitable for cable glands
 Entry thread metric

G	ØD1 mm	ØD2 mm	M mm	Art.-No.	
M12 / Pg 7	13.0	24	1	1007.80.10	100
M16 / Pg 9	16.5	24	1	1017.80.10	100
M20 / Pg 13	20.7	28	1	1020.80.10	100
M25	25.5	32	1	1025.80.10	100
M32	33.0	40	1	1032.80.10	100
M40	40.5	52	1	1040.80.10	100
M50	50.5	62	1	1050.80.10	50
M63	63.5	78	1	1063.80.10	50



Erdungslaschen zu Kabelverschraubungen
 Anschlussgewinde Pg

Grounding straps suitable for cable glands
 Entry thread Pg

G	ØD1 mm	ØD2 mm	M mm	Art.-No.	
M12 / Pg 7	13.0	24	1	1007.80.10	100
M16 / Pg 9	16.5	24	1	1017.80.10	100
Pg 11	19.0	28	1	1011.80.10	100
M20 / Pg 13	20.7	28	1	1020.80.10	100
Pg 16	23.0	32	1	1016.80.10	100
Pg 21	29.0	37	1	1021.80.10	100
Pg 29	38.0	52	1	1029.80.10	50
Pg 36	48.0	62	1	1036.80.10	50



Evolution EMC Komponenten
Evolution EMC components



112 - 114

Evolution EMC Werkzeug
Evolution EMC tool



115 - 118

1

2

3

4

5

6

7

8

9

10

11

12

13

14

15

EVolution EMC Kabelverschraubungen

EVolution EMC cable glands

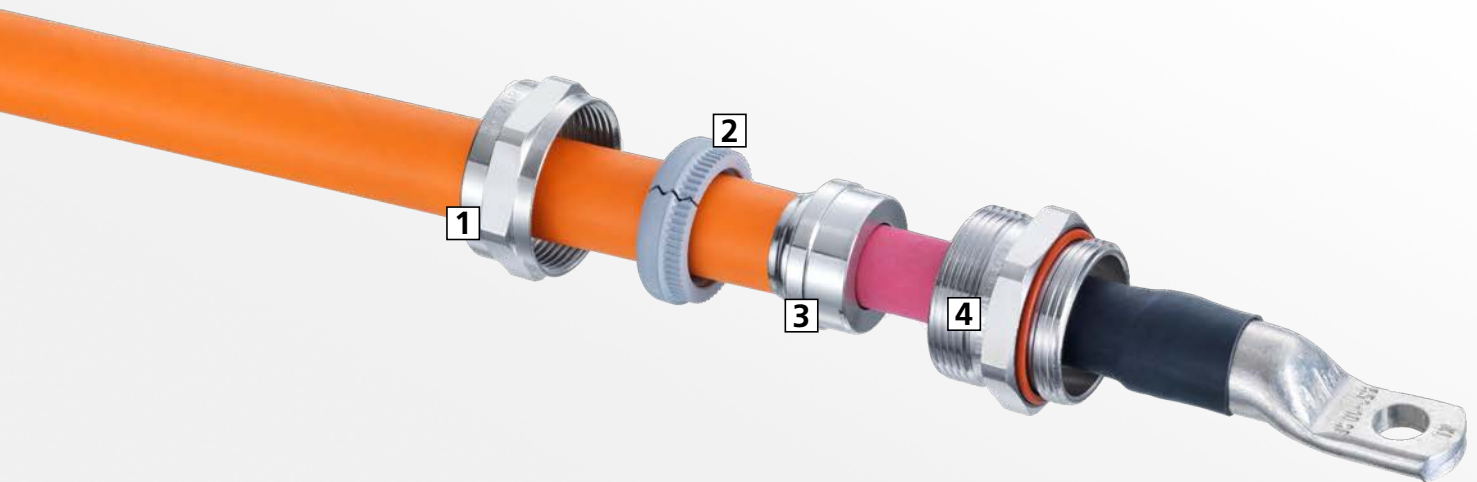

Die **EVolution EMC** Kabelverschraubung gewährleistet eine prozesssichere und langlebige Schirmanbindung von geschirmten Kabeln im Bereich der Elektromobilität. Die neue Konstruktion erlaubt das mehrmalige Stecken des Schirmkontaktes im Unterteil und ermöglicht so die Vorkonfektionierung der Kabel. Vorkonfektionierte Kabelbäume senken die Montagekosten, vereinfachen die Fertigungsabläufe und sind anwenderfreundlich. Das System erlaubt eine Konfektionierung der Kabel im Feld durch das Akku betriebene AXI PRESS Werkzeugtool. Dies ermöglicht Reparaturen an Kabelbäumen sowie auch die flexible und passgenaue Konfektionierung von Prototypen. Die **EVolution EMC** Kabelverschraubung wurde gezielt für den Einsatz in elektrisch betriebenen Fahrzeugen entwickelt und widersteht somit den härtesten Anforderungen im Betrieb.

1 Druckmutter

Bleifreie Ausführung in 3 Grössen M20, M25 und M32; Vereinfachte Montage; Anziehen bis Anschlag (kein Drehmoment erforderlich).

2 Dichteinsatz

Höchster IP Schutzgrad; Verdrehenschutz des Kabels durch Verzahnung; grosser Temperaturbereich -40 bis 140°C.

3 Kontakt- und Stützhülse

Die steckbare EMV-Schirmkontaktlösung garantiert eine schnelle und prozesssichere Montage; hochwertige 360° Kontaktierung.

4 Unterteil

Bleifreie Ausführung in 3 Grössen M20, M25 und M32; grosse Lichtweite für die Durchführung von Kabelschuhen.

The **EVolution EMC** cable gland ensures the reliable and durable shield connection of shielded cables in electromobility applications. Its innovative design enables the shield contact to be repeatedly "plugged into" the cable gland's lower part, thus facilitating pre-assembly on the cable. Pre-assembled cable harnesses reduce installation costs, simplify production processes and are user-friendly. The system also allows this pre-assembly work to be carried out in the field using the battery-operated AXI PRESS tool. This enables cable harnesses to be repaired, and prototypes to be flexibly and precisely assembled. The **EVolution EMC** cable gland was specially developed for use in electrically powered vehicles and can therefore withstand the most demanding operating requirements.

1 Compression nut

Lead-free version in three sizes (M20, M25 and M32); Simplified installation; Just tighten to the stop (no torque required).

2 Sealing insert

Highest IP protection level; Anti-rotation design thanks to surface profile; Wide temperature range (-40 to +140°C).

3 Contact sleeve and supporting ring

The "pluggable" EMC shield contact solution facilitates quick and reliable installation; Ensures high-quality 360° contact.

4 Lower part

Lead-free design in three sizes (M20, M25 and M32); Large clearance for cable lugs to pass through.

Montage / Assembly



1. Kabelschuh durchschieben
1. Push cable lug through



2. Kontakthülse einstecken
2. Plug in contact sleeve



3. Dichteinsatz einschieben
3. Push in sealing insert



4. Druckmutter festziehen
4. Tighten compression nut

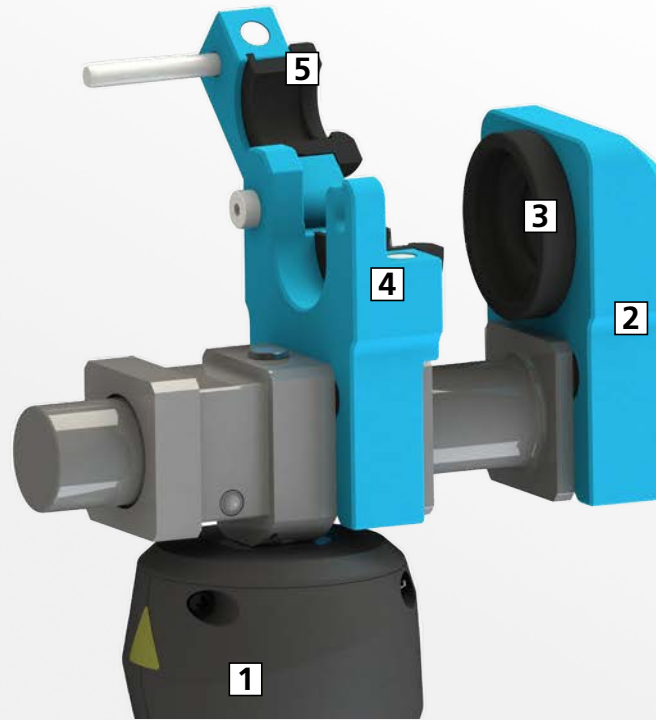

Die **AXI PRESS** wird zur Erstellung des Schirmkontakts für die **Evolution EMC** Kabelverschraubung eingesetzt. Das akkubetriebene Handwerkzeug wird im praktischen Kofferset ausgeliefert, inklusive Ladegerät. Die kabelspezifischen Werkzeugeinsätze sind codiert und können in die Press- und Bördelvorrichtung montiert werden, wo sie über Magnete in Position gehalten werden. Für eine optimierte Arbeitsweise kann die Bördelvorrichtung aufgeklappt werden, um das vorkonfektionierte Kabel einfacher zu entfernen. Über die Infrarot-Schnittstelle können die aufgezeichneten Daten auf einen PC übertragen werden und erlaubt so das dokumentieren jedes einzelnen Pressvorganges. Die **AXI PRESS** ist ein Markenprodukt und der Service ist weltweit sichergestellt.

1 AXI PRESS

Akkuhydraulisches Presswerkzeug; im robusten Koffer mit Ladegerät und Akku: Datenschnittstelle für die Prozessdokumentation; einfachste Bedienung.

2 Pressvorrichtung

Halter für Presseinsatz, ist im Set enthalten.

3 Presseinsatz

3 Größen M20, M25 und M32.

4 Bördelvorrichtung

Klappbarer Halter für die Bördelinsätze, ist im Set enthalten.

5 Bördelinsatz

Auf die HV-Leitungen abgestimmte Einsätze.

The **AXI PRESS** tool is used to crimp the shield contact for the **Evolution EMC** cable gland. The battery-powered handheld tool is supplied in a practical case, including a charger. The cable-specific inserts are coded to ensure proper positioning in the compression and flange devices, where they are held in place by magnets. To remove the pre-assembled cable, the flange device can be opened quickly and easily. The recorded data can be transferred to a computer via the infrared interface, thus facilitating the documentation of each individual use. **AXI PRESS** is a proprietary product, and a maintenance/repair service is ensured worldwide.

1 AXI PRESS

Battery-powered hydraulic compression tool; In a robust case with charger and battery; Data interface for process documentation; Simple operation.

2 Compression device

Mounting frame for compression insert (included).

3 Compression insert

Three sizes – M20, M25 and M32.

4 Flange device

Hinged mounting frame for flange inserts (included).

5 Flange insert

Two-part insert to suit the HV cable.



Druckmutter | Compression nut

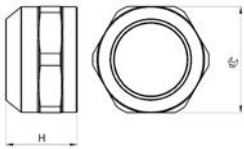



Material: Messing CuZn21Si3P bleifrei
 Schutzart: IP 68 / IP 6K9K
 Einsatztemperatur: -40 °C / +140 °C

Material: Brass CuZn21Si3P lead-free
 Protection class: IP 68 / IP 6K9K
 Operation temperature: -40 °C / +140 °C



Bleifreies Messing
 Elektromobilität

Lead-free brass
 Electromobility

G	 mm	H mm	Art.-No.	
M20x1.5	24	19	1089.20.01LF	25
M25x1.5	30	20	1089.25.01LF	25
M32x1.5	36	17.5	1089.32.01LF	25



Dichteinsatz | Sealing insert

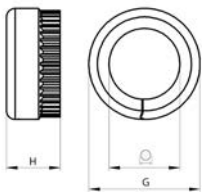

Material: Silikon HCR
 Schutzart: IP 68 / IP 6K9K
 Einsatztemperatur: -40 °C / +140 °C

Material: Silikon HCR
 Protection class: IP 68 / IP 6K9K
 Operation temperature: -40 °C / +140 °C



Elektromobilität

Electromobility

G	H mm			 info	Art.-No.	
M20	10	9.8	16	-	1089.20.97.098.03	25
M20	10	10.3	16	-	1089.20.97.103.03	25
M20	10	11.4	2x4	2	1089.20.97.114.03	25
M20	10	13.2	35	-	1089.20.97.132.03	25
M20	10	14.6	35	-	1089.20.97.146.03	25
M25	10	13.2	35	-	1089.25.97.132.03	25
M25	10	14.6	35	-	1089.25.97.146.03	25
M25	10	15.4	50	-	1089.25.97.154.03	25
M25	10	16.0	50	-	1089.25.97.160.03	25
M25	10	17.5	70	-	1089.25.97.175.03	25
M25	10	18.4	70	-	1089.25.97.184.03	25
M32	10	17.5	70	-	1089.32.97.175.03	25
M32	10	18.4	70	-	1089.32.97.184.03	25
M32	10	20.0	95	-	1089.32.97.200.03	25
M32	10	21.0	95	-	1089.32.97.210.03	25
M32	10	22.7	120	-	1089.32.97.227.03	25
M32	10	23.1	120	-	1089.32.97.231.03	25

2 = Zulassungen in Vorbereitung

2 = Approvals in preparation

Auf Anfrage lieferbar:

Available on request:

Andere Kabeltypen / Querschnitte





Other cable types / cross sections

Unterteil metrisch kurz | Lower part metric short

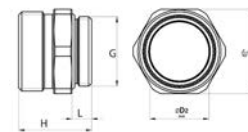
Material: Messing CuZn21Si3P bleifrei
 Kontaktfeder: Berylliumkupfer
 O-Ring: Silikon
 Schutzart: IP 68 / IP 6K9K
 Einsatztemperatur: -40 °C / +140 °C





Material: Brass CuZn21Si3P lead-free
 Contact spring: beryllium copper
 O-ring: Silikon
 Protection class: IP 68 / IP 6K9K
 Operation temperature: -40 °C / +140 °C



Bleifreies Messing Elektromobilität				Lead-free brass Electromobility			
G	 mm	H mm	L mm	ØD2 mm	Art.-No.		
M20x1.5	24	25	6	16.1	1089.20.02LF		25
M25x1.5	30	26	7	21.1	1089.25.02LF		25
M32x1.5	36	27	8	27.4	1089.32.02LF		25



Unterteil metrisch lang | Lower part metric long





Bleifreies Messing Elektromobilität				Lead-free brass Electromobility			
G	 mm	H mm	L mm	ØD2 mm	Art.-No.		
M20x1.5	24	29	10	16.1	1189.20.02LF		25
M25x1.5	30	30	11	21.1	1189.25.02LF		25
M32x1.5	36	32	13	27.4	1189.32.02LF		25



Schutzkappe zum Unterteil | Protection cap to lower part

Material: TPE gelb
 Einsatztemperatur: -40 °C / +120 °C

Material: TPE yellow
 Operation temperature: -40 °C / +120 °C

Elektromobilität				Electromobility			
G	H mm	Ø mm			Art.-No.		
M20	36.5	24.2			1089.20.20		25
M25	36.5	30.3			1089.25.25		25
M32	25.2	37.9			1089.32.32		25



Kontakthülse | Contact sleeve

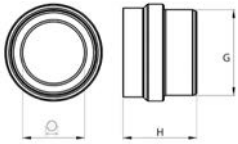

Material: Kupfer
 EMV-Schirmdämpfung: > 86 dB
 Einsatztemperatur: -40 °C / +140 °C

Material: Copper
 EMC attenuation: > 86 dB
 Operation temperature: -40 °C / +140 °C



Bleifrei Elektromobilität		lead-free Electromobility				
G	H mm	 info	 info	Art.-No.		
M20	18	9.8	16	-	1089.20.098.04	25
M20	18	10.3	16	-	1089.20.103.04	25
M20	18	11.4	2x4	2	1089.20.114.04	25
M20	18	13.2	35	-	1089.20.132.04	25
M20	18	14.6	35	-	1089.20.146.04	25
M25	18	13.2	35	-	1089.25.132.04	25
M25	18	14.6	35	-	1089.25.146.04	25
M25	18	15.4	50	-	1089.25.154.04	25
M25	18	16.0	50	-	1089.25.160.04	25
M25	18	17.5	70	-	1089.25.175.04	25
M25	18	18.4	70	-	1089.25.184.04	25
M32	18	17.5	70	-	1089.32.175.04	25
M32	18	18.4	70	-	1089.32.184.04	25
M32	18	20.0	95	-	1089.32.200.04	25
M32	18	21.0	95	-	1089.32.210.04	25
M32	18	22.7	120	-	1089.32.227.04	25
M32	18	23.1	120	-	1089.32.231.04	25

2 = Zulassungen in Vorbereitung 2 = Approvals in preparation
 Auf Anfrage lieferbar: Available on request:
 Andere Kabeltypen / Querschnitte Other cable types / cross sections

Stützhülse | Supporting ring

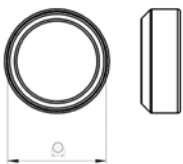

Material: Messing CuZn21Si3P bleifrei
 EMV-Schirmdämpfung: > 86 dB
 Einsatztemperatur: -40 °C / +140 °C

Material: Brass CuZn21Si3P lead-free
 EMC attenuation: > 86 dB
 Operation temperature: -40 °C / +140 °C





Bleifrei Elektromobilität		lead-free Electromobility			
 info	 info	 info	 info	Art.-No.	
9.8	16	-	-	1089.098.05	25
10.3	16	-	-	1089.103.05	25
11.4	2x4	2	-	1089.114.05	25
13.2	35	-	-	1089.132.05	25
14.6	35	-	-	1089.146.05	25
15.4	50	-	-	1089.154.05	25
16.0	50	-	-	1089.160.05	25
17.5	70	-	-	1089.175.05	25
18.4	70	-	-	1089.184.05	25
20.0	95	-	-	1089.200.05	25
21.0	95	-	-	1089.210.05	25
22.7	120	-	-	1089.227.05	25
23.1	120	-	-	1089.231.05	25

2 = Zulassungen in Vorbereitung 2 = Approvals in preparation
 Auf Anfrage lieferbar: Available on request:
 Andere Kabeltypen / Querschnitte Other cable types / cross sections

AXI PRESS Set | AXI PRESS set

Eigenschaften:	1 x Zange mit Koffer 1 x Ladegerät 1 x Akku 18V - 5.0 Ah 1 x Bördelvorrichtung 1 x Pressvorrichtung 5 x Einsätze	Properties:	1 x Pliers in the Tool case 1 x Charger 1 x Battery 18V - 5 Ah 1 x Flange device 1 x Compression device 5 x inserts
----------------	---	-------------	--

Prozesssichere Verarbeitung Elektromobilität	Reliable processing Electromobility				
L mm	B mm	H mm		Art.-No.	
574	423	170	220 - 240 V	4801.900	1



AXI PRESS Bördelvorrichtung | AXI PRESS flange device

Material:	Alu (AlMgSi0.5)	Material:	Alu (AlMgSi0.5)
Eigenschaften:	AXI PRESS EVolution EMC	Properties:	AXI PRESS EVolution EMC

Prozesssichere Verarbeitung Elektromobilität	Reliable processing Electromobility				
L mm	B mm	H mm		Art.-No.	
110	110	55		4801.00.02	1



AXI PRESS Pressvorrichtung | AXI PRESS compression device

Prozesssichere Verarbeitung Elektromobilität	Reliable processing Electromobility				
L mm	B mm	H mm		Art.-No.	
110	110	55		4801.00.01	1



AXI PRESS Presseinsätze | AXI PRESS compression insert

Material: gehärteter Kaltarbeitsstahl
brüniert
Eigenschaften: AXI PRESS EVolution EMC

Material: hardened cold work steel
burnished
Properties: AXI PRESS EVolution EMC



Prozesssichere Verarbeitung
Elektromobilität

Reliable processing
Electromobility

G	Art.-No.	
M20	4801.20.01	1
M25	4801.25.01	1
M32	4801.32.01	1

AXI PRESS Bördeleinsätze | AXI PRESS flange insert

Material: gehärteter Kaltarbeitsstahl
brüniert
Eigenschaften: AXI PRESS EVolution EMC

Material: hardened cold work steel
burnished
Properties: AXI PRESS EVolution EMC





Prozesssichere Verarbeitung
Elektromobilität

Reliable processing
Electromobility

		Art.-No.	
9.8	16	4801.098.01	1
10.3	16	4801.103.01	1
11.4	2x4	4801.114.01	1
13.2	35	4801.132.01	1
14.6	35	4801.146.01	1
15.4	50	4801.154.01	1
16.0	50	4801.160.01	1
17.5	70	4801.175.01	1
18.4	70	4801.184.01	1
20.0	95	4801.200.01	1
21.0	95	4801.210.01	1
22.7	120	4801.227.01	1
23.1	120	4801.231.01	1

AXI PRESS Ladegerät | AXI PRESS charger



Eigenschaften: AXI PRESS EVolution EMC Properties: AXI PRESS EVolution EMC

Prozesssichere Verarbeitung Elektromobilität	Reliable processing Electromobility		
		Art.-No.	
220 - 240 V		4801.02EU	1



AXI PRESS Akku | AXI PRESS akku

Eigenschaften: AXI PRESS EVolution EMC Properties: AXI PRESS EVolution EMC

Prozesssichere Verarbeitung Elektromobilität	Reliable processing Electromobility		
		Art.-No.	
5.0 Ah		4801.01	1



1
2
3
4
5
6
7
8
9
10
11
12
13
14
15

AXI PRESS Zange | AXI PRESS pliers

Eigenschaften: 1 x Zange mit Koffer,
1 x Ladegerät, 1 x Akku

Properties: 1 x Pliers in the Tool case,
1 x Charger, 1 x Battery 5 Ah



Prozesssichere Verarbeitung
Elektromobilität

Reliable processing
Electromobility

L mm	B mm	H mm	
574	423	170	220 - 240 V

Art.-No.



4801.EU

1



Mehrfachdurchführung MCE
Multi Cable Entry MCE



121

Dichteinsätze Vollgummi
Solid rubber sealing inserts



121

1

2

3

4

5

6

7

8

9

10

11

12

13

14

15

Mehrfachdurchführung MCE

Multi Cable Entry MCE



AGRO Mehrfachdurchführungen MCE für dichte und prozesssichere Kabeldurchführungen

Seit über 65 Jahren entwickelt und fertigt AGRO hochwertige Kabelverschraubungen nach EN 62444. Dieses Know-how aus der radialen Verpressung von Dichteinheiten kommt nun erstmals in Kabeldurchführungen zum Einsatz. Die spezielle Konstruktion einer sicheren Zugentlastung und die Verwendung von geprüften Dichteinheiten machen die innovativen MCE zu einem extrem robusten und zuverlässigen Kabeldurchführungssystem.

Mehrfachdurchführungen sind weit verbreitet und werden in verschiedenen Branchen genutzt. Sie kommen überall dort zum Einsatz, wo eine grössere Anzahl Kabel in einer geforderten Packungsdichte hindurch zu führen ist.

1 MCE System

- Verlässliche Prozesssicherheit
- Grosse Robustheit und Dichtigkeit
- Auch für Anwendungen mit erhöhten Umweltaforderungen geeignet
- Vorkonfektionierte Systeme können am Montageort rationell installiert werden
- Für die Montage sind keine weiteren Hilfs- oder Schmierstoffe nötig

2 Dichteinheiten

- Millionenfach bewährt in Standard-Kabelverschraubungen
- Abdichtung nach IP 68 (min. 0,1 bar während 30 Minuten)
- Sicherstellung hoher Auszugskräfte
- Kabel-Klemmbereich von Ø 5.5 bis 21.5 mm
- Geschlitzt für den Austausch im Servicefall

3 Gehäuse

- Hochfeste Halbschalen aus eloxiertem Aluminium
- An branchenüblichen Standardabmessungen orientiertes Bohrbild

AGRO's multi-cable entry MCE – for well-sealed, process-reliable cable entries

AGRO has been developing and manufacturing high-quality cable glands in accordance with EN 62444 for over 65 years. The know-how gained from this in relation to seal radial compression is now being used for the first time in cable feedthroughs. The specially designed, reliable strain relief and the use of tested sealing units make MCE an innovative, extremely robust and highly dependable cable entry system.

Multi-cable entries are widely used in various industries. They find application anywhere where a number of cables are to be fed, close together, through a wall or partition.

1 MCE system

- High process reliability
- Offers robustness and excellent sealing performance
- Also suitable for applications in challenging environments
- Pre-assembled systems can be efficiently installed on site
- No supplementary materials or lubricants needed for installation

2 Sealing elements

- Well-proven from millions of applications in standard cable glands
- Sealing according to IP68 (min. 0.1 bar for 30 minutes)
- Resistant to high pull-out forces
- Cable clamping range from Ø 5.5 to 21.5 mm
- Split for easy replacement if necessary

3 Housing

- High-strength half-casings of anodised aluminium
- Hole pattern based on customary standard dimensions



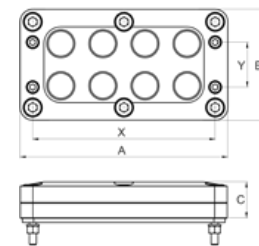

Aluminium gefräst, einteiliges System | Milled aluminium, one-piece system

Material:	Aluminium eloxiert	Material:	Aluminium anodised
Dichtung:	NBR	Seal:	NBR
Flachdichtung:	CR (Chloropren-Kautschuck)	Flat gasket:	CR (chloroprene rubber)
Zugentlastung:	Ausführung nach EN 62444	Strain relief:	Version to EN 62444
Schutzart:	IP 68	Protection class:	IP 68
Eigenschaften:	Schnell- und kostensparend montiert, extrem robust und flexibel, keine Hilfs- und Schmierstoffe nötig	Properties:	Fast and cost-saving assembly, extremely robust and flexible, no auxiliary materials and lubricants necessary
Einsatztemperatur:	-30 °C / +105 °C	Operation temperature:	-30 °C / +105 °C



Hohe Dichtheit IP 68
Absolute Prozesssicherheit
Hohe Auszugskräfte nach EN 62444

High tightness IP 68
Absolute process safety
High pull-out forces according to EN 62444

			A mm	B mm	C mm	X mm	Y mm			Art.-No.	
10	5.5	7.5	148	79	26	130	32	M5	112x50	1908.88.10.001	1
8	7.5	10	148	79	26	130	32	M5	112x50	1908.88.08.002	1
8	10	12.5	148	79	26	130	32	M5	112x50	1908.88.08.003	1
8	12.5	15.5	148	79	26	130	32	M5	112x50	1908.88.08.004	1
3	15.5	18.5	148	79	26	130	32	M5	112x50	1908.88.03.005	1
3	18.5	21.5	148	79	26	130	32	M5	112x50	1908.88.03.006	1



passend zu Mehrfachdurchführung MCE | suitable for multi cable entry MCE

Material:	NBR	Material:	NBR
Einsatztemperatur:	-30 °C / +105 °C	Operation temperature:	-30 °C / +105 °C

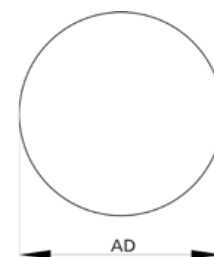

G	AD mm		Art.-No.	
M20	19	1908.88.10.001	1900.19.30.03	5
M20	23	1908.88.08.002	1900.23.30.03	5
M25	26	1908.88.08.003 + 1908.88.08.004	1900.26.30.03	5
M32	34	1908.88.03.005 + 1908.88.03.006	1900.34.30.03	5

Dichteinsätze ohne Bohrung lassen sich gut bearbeiten, wenn sie vorher auf mindestens -25°C gefroren wurden. When frozen to at least -25°C, the solid sealing inserts are easy to drill.



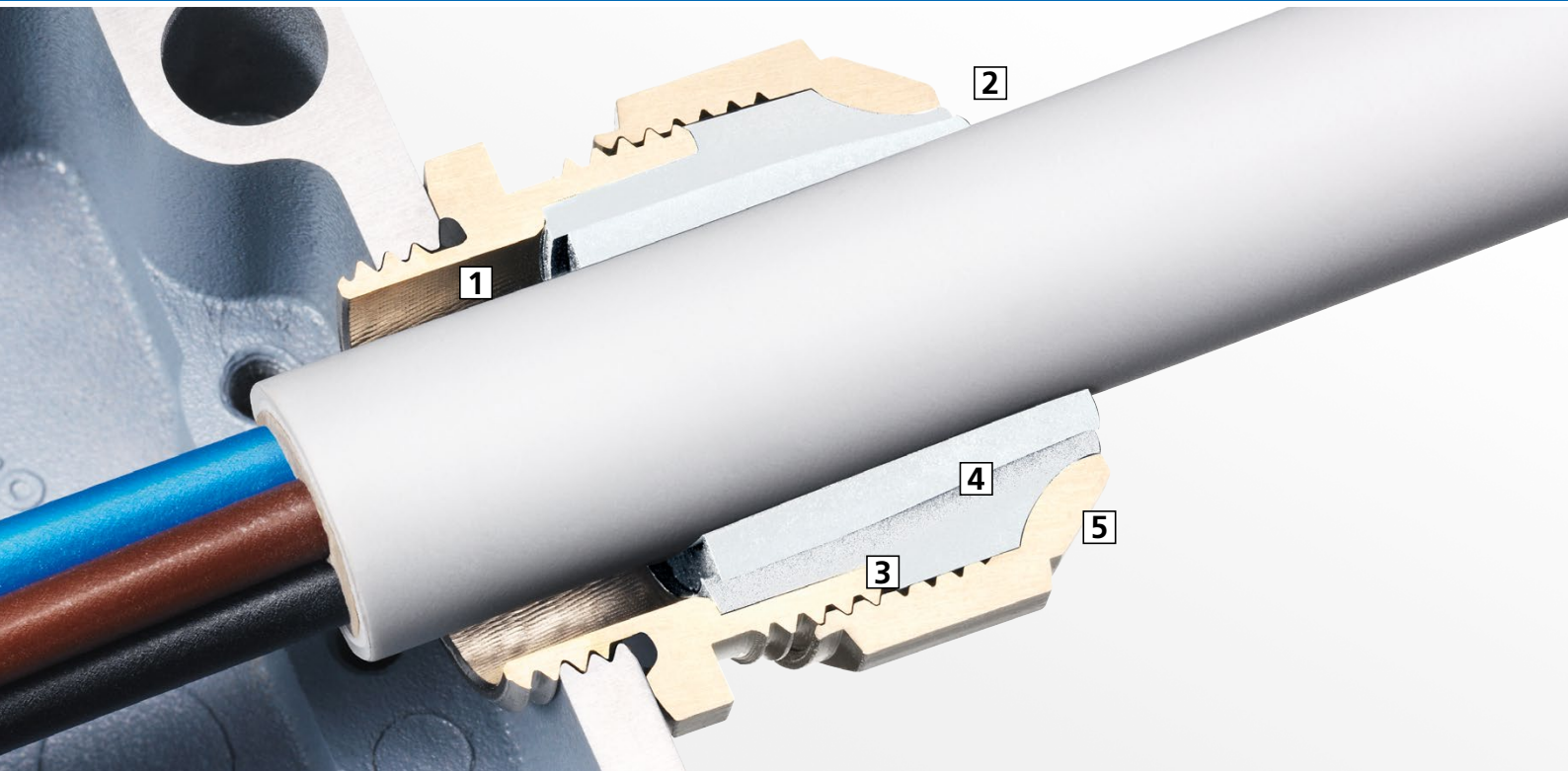

AGRO Kabelverschraubungen Progress® in Metall für den Einsatz in Schienenfahrzeugen

AGRO Progress® Kabelverschraubungen aus Metall können mit Dichteinsätzen aus einem speziellem TPE bestückt werden. In dieser Ausführung sind sie zertifiziert nach EN 45545 sowie NFPA 130 und können bedenkenlos für alle Anwendungen und Anordnungen im Schienenfahrzeugbau eingesetzt werden.

1 Kurze, lange oder Spezial-Anschlussgewinde

Kabelverschraubungen Progress® mit kurzem oder langem Anschlussgewinde in metrischer oder Pg-Ausführung können bei vorhandenem Öffnungsgewinde oder mit Gegenmutter verwendet werden.

2 Sichtbare Sicherheit

Der kleine Wulst des Dichteinsatzes bestätigt das richtige Anzugsdrehmoment.

3 Hoher Verdrehenschutz

Die im Unterteil integrierte Längsrandrierung sorgt über den Dichteinsatz für eine hohe Verdrehsicherheit.

4 Kompressionstechnik

Die ein- oder zweiteiligen Dichteinsätze werden durch die Druckmutter verpresst und eine ausserordentlich kabelschonende Zugentlastung wird erreicht. Der Kabelmantel bleibt selbst bei dynamischen Anwendungen langfristig intakt.

5 Garantierte Dichtigkeit

Auf den Dichteinsatz abgestimmte Innenkonturen sorgen für eine zielgerichtete Verformung des Dichteinsatzes und garantieren somit dessen perfekte Abdichtung. Die Schutzarten IP 68 bis 10 bar sowie IP 69 ermöglichen eine breite Anwendung.

AGRO metal cable glands Progress® for rolling stock applications

AGRO Progress® metal cable glands can be equipped with sealing inserts made of a special TPE. These versions are certified according to EN 45545 and NFPA 130 and can be used with confidence for any rolling stock application.

1 Short, long or special entry thread

Cable glands Progress® with short or long entry thread designed as metric or Pg can be used with existing hole threads or with a counter nut.

2 Visible reliability

The small bulge in the sealing insert confirms the correct tightening torque.

3 Good anti-rotation protection

The integrated retaining grooves in the lower part and in the sealing insert protect against rotation.

4 Compression technology

The one- or two-part sealing inserts are compressed by the compression nut. A very cable-protecting strain relief is produced. The cable jacket will not be harmed, even in case of long-term dynamic stress.

5 Guaranteed seal

Inner contours matched to the sealing insert ensure a targeted deformation of the insert and thus guarantee its tightness in compliance with protection class IP 68 up to 10 bar and IP 69 for a wide range of applications.



<p>Kabelverschraubungen Progress® nach EN 45545-2/-3 und NFPA 130 Cable glands Progress® according to EN 45545-2/3 and NFPA 130</p>		<p>126 - 128</p>	<p>1</p>
<p>Kabelverschraubungen Progress® nach EN 45545-2/-3 und NFPA 130 für mehrere Kabel Cable glands Progress® according to EN 45545-2/3 and NFPA 130 for installation of multiple cables</p>		<p>132 - 133</p>	<p>2</p>
<p>Kabelverschraubungen Progress® nach EN 45545-2/-3 und NFPA 130 mit Knickschutzfeder Cable glands Progress® according to EN 45545-2/3 and NFPA 130 with antikink spring</p>		<p>134</p>	<p>3</p>
<p>Kabelverschraubungen Progress® nach EN 45545-2/-3 und NFPA 130 mit Klemmbacken Cable glands Progress® according to EN 45545-2/3 and NFPA 130 with clamps</p>		<p>135</p>	<p>4</p>
<p>Kabelverschraubungen Progress® nach EN 45545-2/-3 und NFPA 130 EMV easyCONNECT Messing mit Kontaktfeder Cable glands Progress® according to EN 45545-2/3 and NFPA 130 EMC easyCONNECT with contact spring</p>		<p>136</p>	<p>5</p>
<p>Kabelverschraubungen Progress® nach EN 45545-2/-3 und NFPA 130 EMV powerCONNECT Messing Cable glands Progress® according to EN 45545-2/3 and NFPA 130 EMC powerCONNECT nickel-plated brass</p>		<p>137 - 138</p>	<p>6</p>
<p>Kabelverschraubungen Progress® nach EN 45545-2/-3 und NFPA 130 EMV Serie 85 Messing mit Spannzange Cable glands Progress® according to EN 45545-2/3 and NFPA 130 EMC Serie 85 nickel-plated brass with collet chuck</p>		<p>139</p>	<p>7</p>

8

9

10

11

12

13

14

15



Beste Resultate bei Prüfungen nach EN 45545-2 (Komponenten)

Die Dichteinsätze der Progress® Kabelverschraubung sind aus einem speziellen TPE gefertigt und sind im anspruchsvollsten **Hazard Level 3 (R22/R23) zertifiziert**.

Die geforderten Werte für Hazard Level 3 wurden sowohl im Aussen- als auch im Innenbereich deutlich übertroffen:

Best results in testing according to EN 45545-2 (Components)

The seal inserts of Progress® cable glands are made of a special TPE and **certified to the demanding Hazard Level 3 (R22/R23)**.

The stipulated values for Hazard Level 3 were exceeded, for both indoor and outdoor areas

	Normwert für HL 3 aussen Requirement for HL 3 outdoor	Normwert für HL 3 innen Requirement for HL 3 indoor	AGRO Resultat AGRO result
Sauerstoffindex Oxygen index	Min. 32%	Min. 32%	39%
Rauchgasdichte Ds Smoke density Ds	Max. 300	Max. 150	110
Toxizität CIT Toxicity CIT	Max. 1.5	Max. 0.75	0.16

Vorgaben der EN 45545-3 übertroffen!

Ziel der **EN 45545-3** ist es, die Brandausbreitung durch Materialanforderungen zu begrenzen. Wenn Kabel durch Feuerschutzabschlüsse geführt werden, gelten diese Anforderungen auch für Kabelverschraubungen.

AGRO Progress® Kabelverschraubungen aus Metall übertreffen die Vorgaben der **EN 45545-3** bei weitem und erreichen die sehr hohe Feuerwiderstandsklasse **E30**. Die Dichteinsätze sind mindestens 30 Minuten lang dicht und verhindern einen Flammenübertrag auf die dem Feuer abgewandte Seite und es bilden sich keine Spalten. Sie können aus brandschutztechnischer Sicht bedenkenlos in allen Schienenfahrzeugen eingesetzt werden.

Exceeding the demands of EN 45545-3!

The aim of **EN 45545-3** is to limit fire spread by specifying the performance of materials and components. If cables are routed through fire barriers, the requirements apply also to the cable glands used.

AGRO Progress® metal cable glands easily exceed the requirements of **EN 45545-3** and satisfy the very high demands of fire resistance class **E30**. This means that the seal inserts remain impervious and prevent the spread of fire through the gland for at least 30 minutes. They do not crack or fissure. From a fire protection perspective, they can be used without hesitation in all railway vehicles.

	Einbaulage vertikal Vertical installation	Einbaulage horizontal Horizontal installation	Klassierung Classification
AGRO Resultat AGRO Result	44 min	41 min	E30

	Progress® Messing Progress® nickel-plated brass	Standard Standard	EMV Kabelverschraubungen EMC cable glands	Kombi-Schlauchverschraubungen Combination conduit glands	Winkel 90° +45° Elbow 90° +45°	Für mehrere Kabel For multiple cables	Mit Dichteinsatz With sealing insert	Für spezielle Kabel For special cables	Mit Knickschutzfeder With anti-kink spring	Mit Trompete und / oder Klemmbacken With trumpet and / or clamps	
Ausführung / Design											
Kompressionstechnik Compression technology	•	•	•	•	•	•	•	•	•	•	1
Gewinde / Thread											
Anschlussgewinde metrisch Entry thread metric	•	•	•	•	•	•	•	•	•	•	2
Anschlussgewinde Pg Entry thread Pg	•	•	•	•	•	•	•	•	•	•	3
Kurzes Anschlussgewinde (Standard) Short entry thread (standard)	•	•	•	•	•	•	•	•	•	•	4
Langes Anschlussgewinde Long entry thread	•	•	•	•	•	•	•	•	•	•	5
Sondergewinde (extra lang, Innengewinde) Special thread (extra-long, internal thread)	•	-	-	-	-	-	-	-	-	-	6
Dichteinsatz nach EN 45545 / Sealing insert according to EN 45545											
Für Rundkabel For round cables	•	•	•	•	•	-	-	•	•	•	7
Für Flachkabel For flat cables	•	-	-	-	-	-	•	-	-	-	8
Für mehrere Kabel (Multi-Dichteinsatz) For several cables (Multi-sealing insert)	•	•	-	-	•	-	-	-	-	-	9
Vollgummi-Dichteinsatz Solid rubber sealing insert	•	•	-	-	-	•	-	-	-	-	10
Einteiliger Dichteinsatz One-piece sealing insert	•	•	-	-	•	•	•	•	-	-	11
Zweiteiliger Dichteinsatz Two-piece sealing insert	•	•	•	•	-	-	-	•	•	•	12
Technische Besonderheiten / Technical features											
Vibrationsschutz Vibration resistance	•	•	•	•	•	•	•	•	•	•	13
Material / Material											
Messing vernickelt Nickel-plated brass	•	•	•	•	•	•	•	•	•	•	14
Rostfreier Stahl A2 Stainless steel A2	•	-	-	-	•	•	•	-	-	-	15

Kabelverschraubungen Progress® nach EN 45545-2/3 und NFPA 130

Cable glands Progress® according to EN 45545-2/3 and NFPA 130

Kurzes Anschlussgewinde metrisch | Short entry thread metric

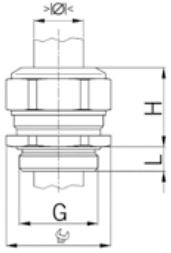

Material: Messing vernickelt
 Dichtung: Spezial AGRO TPE hellgrau
 O-Ring: NBR
 Zugentlastung: Ausführung A nach EN 62444
 Schutzart: IP 68 (bis 10 bar) / IP 69
 Einsatztemperatur: -50 °C / +105 °C

Material: Nickel-plated brass
 Seal: Special AGRO TPE light grey
 O-ring: NBR
 Strain relief: Version A acc. to EN 62444
 Protection class: IP 68 (up to 10 bar) / IP 69
 Operation temperature: -50 °C / +105 °C



Einteiliger Dichteinsatz
 durchgehend isolierend

One-piece sealing insert
 overall length insulated

G	>math>\varnothing</math> min mm	>math>\varnothing</math> max mm	>math>\varnothing</math> mm	H mm	L mm	i info	Art.-No.	
M6x1.0	2.0	2.5	8	12	5	1	F1060.06.025	50
M6x1.0	2.5	3.0	8	12	5	1	F1060.06.030	50
M8x1.25	2.5	3.0	11	14	5	1	F1060.08.030	50
M8x1.25	3.0	4.0	11	14	5	1	F1060.08.040	50
M10x1.5	3.0	4.0	13	15	5	1	F1060.10.040	50
M10x1.5	4.0	6.0	13	15	5	1	F1060.10.060	50
M12x1.5	3.5	5.0	15	17	5	-	F1060.12.050	50
M12x1.5	5.0	6.5	15	17	5	-	F1060.12.065	50
M12x1.5	6.5	7.5	15	17	5	-	F1060.12.075	50
M16x1.5	4.5	6.0	18	20	5	-	F1060.17.060	50
M16x1.5	6.0	8.0	18	20	5	-	F1060.17.080	50
M16x1.5	8.0	10.5	18	22	5	-	F1060.17.105	50
M20x1.5	6.0	8.0	24	21	6	-	F1060.20.080	50
M20x1.5	8.0	11.0	24	21	6	-	F1060.20.110	50
M20x1.5	11.0	14.5	24	23	6	-	F1060.20.145	50
M25x1.5	9.5	12.5	30	25	7	-	F1060.25.125	25
M25x1.5	12.5	16.0	30	25	7	-	F1060.25.160	25
M25x1.5	16.0	19.0	30	28	7	-	F1060.25.190	25
M32x1.5	17.0	21.0	36	28	8	-	F1060.32.210	25
M32x1.5	21.0	25.5	36	28	8	-	F1060.32.255	25
M40x1.5	24.0	28.5	46	31	8	-	F1060.40.285	10
M40x1.5	28.5	33.0	46	31	8	-	F1060.40.330	10
M50x1.5	33.0	37.0	55	34	9	-	F1060.50.370	10
M50x1.5	37.0	42.0	55	34	9	-	F1060.50.420	10
M63x1.5	40.0	46.0	70	37	10	-	F1060.63.460	5
M63x1.5	46.0	52.0	70	37	10	-	F1060.63.520	5
M75x1.5	50.0	56.0	80	38	11	-	F1060.75.560	1
M75x1.5	56.0	63.0	80	80	11	-	F1060.75.630	1

1 = Metrisches Regelgewinde

1 = Metric coarse-pitch thread

Auf Anfrage lieferbar:

Available on request:

Anschlussgewinde Pg und NPT

Entry thread Pg and NPT



Zweiteiliger Dichteinsatz
 durchgehend isolierend

Two-piece sealing insert
 overall length insulated

G	>math>\varnothing</math> min mm	>math>\varnothing</math> max mm	>math>\varnothing</math> min mm	>math>\varnothing</math> max mm	>math>\varnothing</math> mm	H mm	L mm	Art.-No.	
M16x1.5	6.0	8.0	8.0	10.5	18	22	5	F1060.17	50
M20x1.5	8.0	11.0	11.0	14.5	24	23	6	F1060.20	50
M25x1.5	12.5	16.0	16.0	19.0	30	28	7	F1060.25	25
M32x1.5	17.0	21.0	21.0	25.5	36	28	8	F1060.32	25
M40x1.5	24.0	28.5	28.5	33.0	46	31	8	F1060.40	10
M50x1.5	33.0	37.0	37.0	42.0	55	34	9	F1060.50	10
M63x1.5	41.0	46.0	46.0	52.0	70	37	10	F1060.63	5
M75x1.5	50.0	56.0	56.0	63.0	80	38	11	F1060.75	1

Auf Anfrage lieferbar:

Available on request:

Anschlussgewinde Pg und NPT

Entry thread Pg and NPT

Kabelverschraubungen Progress® nach EN 45545-2/3 und NFPA 130

Cable glands Progress® according to EN 45545-2/3 and NFPA 130

Kurzes Anschlussgewinde metrisch | Short entry thread metric

Material: Messing vernickelt
 Dichtung: Spezial AGRO TPE hellgrau
 O-Ring: NBR
 Zugentlastung: Ausführung A nach EN 62444
 Schutzart: IP 68 (bis 10 bar) / IP 69
 Einsatztemperatur: -50 °C / +105 °C

Material: Nickel-plated brass
 Seal: Special AGRO TPE light grey
 O-ring: NBR
 Strain relief: Version A acc. to EN 62444
 Protection class: IP 68 (up to 10 bar) / IP 69
 Operation temperature: -50 °C / +105 °C

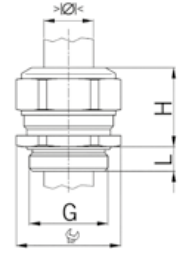

Einteiliger Dichteinsatz
 nicht durchgehend isolierend

One-piece sealing insert
 not overall length insulated

G	>101< min mm	>101< max mm	mm	H mm	L mm	i info	Art.-No.	
M6x1.0	2.0	2.5	8	12	5	1	F1000.06.025	50
M6x1.0	2.0	2.5	8	12	5	1	F1000.06.030	50
M6x1.0	3.0	3.5	8	12	5	1	F1000.06.035	50
M8x1.25	2.5	3.5	11	14	5	1	F1000.08.035	50
M8x1.25	3.5	5.0	11	14	5	1	F1000.08.050	50
M10x1.5	3.0	4.0	13	15	5	1	F1000.10.040	50
M10x1.5	4.0	6.0	13	15	5	1	F1000.10.060	50
M12x1.5	3.5	5.0	15	17	5	-	F1000.12.050	50
M12x1.5	5.0	6.5	15	17	5	-	F1000.12.065	50
M12x1.5	6.5	8.0	15	17	5	-	F1000.12.080	50
M16x1.5	3.5	4.5	18	20	5	-	F1000.17.045	50
M16x1.5	4.5	6.0	18	20	5	-	F1000.17.060	50
M16x1.5	6.0	8.0	18	20	5	-	F1000.17.080	50
M16x1.5	8.0	10.5	18	22	5	-	F1000.17.105	50
M20x1.5	6.0	8.0	24	21	6	-	F1000.20.080	50
M20x1.5	8.0	11.0	24	21	6	-	F1000.20.110	50
M20x1.5	11.0	15.0	24	23	6	-	F1000.20.150	50
M25x1.5	9.5	12.5	30	25	7	-	F1000.25.125	25
M25x1.5	12.5	16.0	30	27	7	-	F1000.25.160	25
M25x1.5	16.0	20.5	30	28	7	-	F1000.25.205	25
M32x1.5	14.0	17.0	36	28	8	-	F1000.32.170	25
M32x1.5	17.0	21.0	36	28	8	-	F1000.32.210	25
M32x1.5	21.0	25.5	36	28	8	-	F1000.32.255	25
M40x1.5	20.0	24.0	46	31	8	-	F1000.40.240	10
M40x1.5	24.0	28.5	46	31	8	-	F1000.40.285	10
M40x1.5	28.5	33.0	46	31	8	-	F1000.40.330	10
M50x1.5	29.0	33.0	55	34	9	-	F1000.50.330	10
M50x1.5	33.0	37.0	55	34	9	-	F1000.50.370	10
M50x1.5	37.0	42.0	55	34	9	-	F1000.50.420	10
M63x1.5	35.0	40.0	70	37	10	-	F1000.63.400	5
M63x1.5	40.0	46.0	70	37	10	-	F1000.63.460	5
M63x1.5	46.0	52.0	70	37	10	-	F1000.63.520	5
M75x1.5	45.0	50.0	80	38	11	-	F1000.75.500	1
M75x1.5	50.0	56.0	80	38	11	-	F1000.75.560	1
M75x1.5	56.0	63.0	80	38	11	-	F1000.75.630	1



1 = Metrisches Regelgewinde
 Auf Anfrage lieferbar:
 Anschlussgewinde Pg und NPT

1 = Metric coarse-pitch thread
 Available on request:
 Entry thread Pg and NPT

Kabelverschraubungen Progress® nach EN 45545-2/3 und NFPA 130

Cable glands Progress® according to EN 45545-2/3 and NFPA 130

Kurzes Anschlussgewinde metrisch | Short entry thread metric

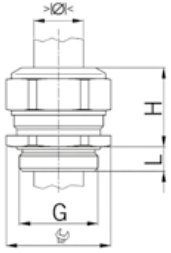

Material: Messing vernickelt
 Dichtung: Spezial AGRO TPE hellgrau
 O-Ring: NBR
 Zugentlastung: Ausführung A nach EN 62444
 Schutzart: IP 68 (bis 10 bar) / IP 69
 Einsatztemperatur: -50 °C / +105 °C

Material: Nickel-plated brass
 Seal: Special AGRO TPE light grey
 O-ring: NBR
 Strain relief: Version A acc. to EN 62444
 Protection class: IP 68 (up to 10 bar) / IP 69
 Operation temperature: -50 °C / +105 °C



Zweiteiliger Dichteinsatz
 nicht durchgehend isolierend

Two-piece sealing insert
 not overall length insulated

G	>Ø< min mm	>Ø< max mm	>Ø< min mm	>Ø< max mm	H mm	L mm	Art.-No.	
M16x1.5	6.0	8.0	8.0	10.5	18	22	F1000.17	50
M20x1.5	8.0	11.0	11.0	15.0	24	23	F1000.20	50
M25x1.5	12.5	16.0	16.0	20.5	30	28	F1000.25	25
M32x1.5	17.0	21.0	21.0	25.5	36	28	F1000.32	25
M40x1.5	24.0	28.0	28.0	33.0	46	31	F1000.40	10
M50x1.5	33.0	37.0	37.0	42.0	55	34	F1000.50	10
M63x1.5	40.0	46.0	46.0	52.0	70	37	F1000.63	5
M75x1.5	50.0	56.0	56.0	63.0	80	38	F1000.75	1

Auf Anfrage lieferbar:
 Anschlussgewinde Pg und NPT

Available on request:
 Entry thread Pg and NPT

Kabelverschraubungen Progress® nach EN 45545-2/3 und NFPA 130

Cable glands Progress® according to EN 45545-2/3 and NFPA 130

Langes Anschlussgewinde metrisch | Long entry thread metric

Material:	Messing vernickelt	Material:	Nickel-plated brass
Dichtung:	Spezial AGRO TPE hellgrau	Seal:	Special AGRO TPE light grey
O-Ring:	NBR	O-ring:	NBR
Zugentlastung:	Ausführung A nach EN 62444	Strain relief:	Version A acc. to EN 62444
Schutzart:	IP 68 (bis 10 bar) / IP 69	Protection class:	IP 68 (up to 10 bar) / IP 69
Einsatztemperatur:	-50 °C / +105 °C	Operation temperature:	-50 °C / +105 °C

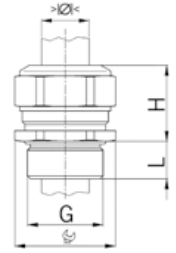

Einteiliger Dichteinsatz durchgehend isolierend

One-piece sealing insert overall length insulated

G	$\begin{matrix} >10< \\ \text{min mm} \end{matrix}$	$\begin{matrix} >10< \\ \text{max mm} \end{matrix}$	$\begin{matrix} >10< \\ \text{mm} \end{matrix}$	$\begin{matrix} >10< \\ \text{mm} \end{matrix}$	$\begin{matrix} >10< \\ \text{mm} \end{matrix}$	$\begin{matrix} >10< \\ \text{mm} \end{matrix}$	$\begin{matrix} >10< \\ \text{info} \end{matrix}$	Art.-No.	
M6x1.0	2.0	2.5	8	12	8	1		F1160.06.025	50
M6x1.0	2.5	3.0	8	12	8	1		F1160.06.030	50
M8x1.25	2.5	3.0	11	14	10	1		F1160.08.030	50
M8x1.25	3.0	4.0	11	14	10	1		F1160.08.040	50
M10x1.5	3.0	4.0	13	15	10	1		F1160.10.040	50
M10x1.5	4.0	6.0	13	15	10	1		F1160.10.060	50
M12x1.5	3.5	5.0	15	17	10	-		F1160.12.050	50
M12x1.5	5.0	6.5	15	17	10	-		F1160.12.065	50
M12x1.5	6.5	7.5	15	17	10	-		F1160.12.075	50
M16x1.5	8.0	10.5	18	22	10	-		F1160.17.105	50
M20x1.5	11.0	14.5	24	23	10	-		F1160.20.145	50
M25x1.5	16.0	19.0	30	28	11	-		F1160.25.190	25
M32x1.5	21.0	25.5	36	28	13	-		F1160.32.255	25
M40x1.5	28.5	33.0	46	34	13	-		F1160.40.330	10
M50x1.5	37.0	42.0	55	34	14	-		F1160.50.420	10
M63x1.5	46.0	52.0	70	37	14	-		F1160.63.520	5
M75x1.5	56.0	63.0	80	38	15	-		F1160.75.630	1



1 = Metrisches Regelgewinde

1 = Metric coarse-pitch thread

Auf Anfrage lieferbar:

Available on request:

Anschlussgewinde Pg und NPT

Entry thread Pg and NPT

Zweiteiliger Dichteinsatz durchgehend isolierend

Two-piece sealing insert overall length insulated

G	$\begin{matrix} >10< \\ \text{min mm} \end{matrix}$	$\begin{matrix} >10< \\ \text{max mm} \end{matrix}$	$\begin{matrix} >10< \\ \text{min mm} \end{matrix}$	$\begin{matrix} >10< \\ \text{max mm} \end{matrix}$	$\begin{matrix} >10< \\ \text{mm} \end{matrix}$	$\begin{matrix} >10< \\ \text{mm} \end{matrix}$	$\begin{matrix} >10< \\ \text{mm} \end{matrix}$	Art.-No.	
M16x1.5	6.0	8.0	8.0	10.5	18	22	10	F1160.17	50
M20x1.5	8.0	11.0	11.0	14.5	24	23	10	F1160.20	50
M25x1.5	12.5	16.0	16.0	19.0	30	28	11	F1160.25	25
M32x1.5	17.0	21.0	21.0	25.5	36	28	13	F1160.32	25
M40x1.5	24.0	28.5	28.5	33	46	31	13	F1160.40	10
M50x1.5	33.0	37.0	37.0	42.0	55	34	14	F1160.50	10
M63x1.5	41.0	46.0	46.0	52.0	70	37	14	F1160.63	5
M75x1.5	50.0	56.0	56.0	63.0	80	38	15	F1160.75	1



Auf Anfrage lieferbar:

Available on request:

Anschlussgewinde Pg und NPT

Entry thread Pg and NPT

Kabelverschraubungen Progress® nach EN 45545-2/3 und NFPA 130

Cable glands Progress® according to EN 45545-2/3 and NFPA 130

Langes Anschlussgewinde metrisch | Long entry thread metric

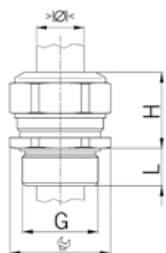

Material: Messing vernickelt
 Dichtung: Spezial AGRO TPE hellgrau
 O-Ring: NBR
 Zugentlastung: Ausführung A nach EN 62444
 Schutzart: IP 68 (bis 10 bar) / IP 69
 Einsatztemperatur: -50 °C / +105 °C

Material: Nickel-plated brass
 Seal: Special AGRO TPE light grey
 O-ring: NBR
 Strain relief: Version A acc. to EN 62444
 Protection class: IP 68 (up to 10 bar) / IP 69
 Operation temperature: -50 °C / +105 °C



Einteiliger Dichteinsatz
 nicht durchgehend isolierend

One-piece sealing insert
 not overall length insulated

G	>D< min mm	>D< max mm	 mm	H mm	L mm	i info	Art.-No.	
M6x1.0	2.0	2.5	8	12	8	1	F1100.06.025	50
M6x1.0	2.5	3.0	8	12	8	1	F1100.06.030	50
M6x1.0	3.0	3.5	8	12	8	1	F1100.06.035	50
M8x1.25	2.5	3.5	11	14	10	1	F1100.08.035	50
M8x1.25	3.5	5.0	11	14	10	1	F1100.08.050	50
M10x1.5	3.0	4.0	13	15	10	1	F1100.10.040	50
M10x1.5	4.0	6.0	13	15	10	1	F1100.10.060	50
M12x1.5	3.5	5.0	15	17	10	-	F1100.12.050	50
M12x1.5	5.0	6.5	15	17	10	-	F1100.12.065	50
M20x1.5	6.5	8.0	15	17	10	-	F1100.12.080	50
M16x1.5	3.5	4.5	18	20	10	-	F1100.17.045	50
M16x1.5	4.5	6.0	18	20	10	-	F1100.17.060	50
M16x1.5	6.0	8.0	18	20	10	-	F1100.17.080	50
M16x1.5	8.0	10.5	18	22	10	-	F1100.17.105	50
M20x1.5	6.0	8.0	24	21	21	-	F1100.20.080	50
M20x1.5	8.0	11.0	24	21	10	-	F1100.20.110	50
M20x1.5	11.0	15.0	24	23	10	-	F1100.20.150	50
M25x1.5	9.5	12.5	30	25	11	-	F1100.25.125	25
M25x1.5	12.5	16.0	30	27	11	-	F1100.25.160	25
M25x1.5	16.0	20.5	30	28	11	-	F1100.25.205	25
M32x1.5	14.0	17.0	36	28	13	-	F1100.32.170	25
M32x1.5	17.0	21.0	36	28	13	-	F1100.32.210	25
M32x1.5	21.0	25.5	36	28	13	-	F1100.32.255	25
M40x1.5	20.0	24.0	46	31	13	-	F1100.40.240	10
M40x1.5	24.0	28.5	46	31	13	-	F1100.40.285	10
M40x1.5	28.5	33.0	46	31	13	-	F1100.40.330	10
M50x1.5	29.0	33.0	55	34	14	-	F1100.50.330	10
M50x1.5	33.0	37.0	55	34	14	-	F1100.50.370	10
M50x1.5	37.0	42.0	55	34	14	-	F1100.50.420	10
M63x1.5	35.0	40.0	70	37	14	-	F1100.63.400	5
M63x1.5	40.0	46.0	70	37	14	-	F1100.63.460	5
M63x1.5	46.0	52.0	70	37	14	-	F1100.63.520	5
M75x1.5	45.0	50.0	80	38	15	-	F1100.75.500	1
M75x1.5	50.0	56.0	80	38	15	-	F1100.75.560	1
M75x1.5	56.0	63.0	80	38	15	-	F1100.75.630	1

1 = Metrisches Regelgewinde

1 = Metric coarse-pitch thread

Auf Anfrage lieferbar:

Available on request:

Anschlussgewinde Pg und NPT

Entry thread Pg and NPT

Kabelverschraubungen Progress® nach EN 45545-2/3 und NFPA 130

Cable glands Progress® according to EN 45545-2/3 and NFPA 130

Langes Anschlussgewinde metrisch | Long entry thread metric

Material:	Messing vernickelt	Material:	Nickel-plated brass
Dichtung:	Spezial AGRO TPE hellgrau	Seal:	Special AGRO TPE light grey
O-Ring:	NBR	O-ring:	NBR
Zugentlastung:	Ausführung A nach EN 62444	Strain relief:	Version A acc. to EN 62444
Schutzart:	IP 68 (bis 10 bar) / IP 69	Protection class:	IP 68 (up to 10 bar) / IP 69
Einsatztemperatur:	-50 °C / +105 °C	Operation temperature:	-50 °C / +105 °C

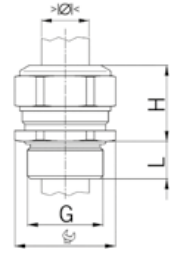

Zweiteiliger Dichteinsatz
nicht durchgehend isolierend

Two-piece sealing insert
not overall length insulated

G	Ø		Ø		H _{br} mm	H mm	L mm	Art.-No.	📦
	min mm	max mm	min mm	max mm					
M16x1.5	6.0	8.0	8.0	10.5	18	22	10	F1100.17	50
M20x1.5	8.0	11.0	11.0	15.0	24	23	10	F1100.20	50
M25x1.5	12.5	16.0	16.0	20.5	30	28	11	F1100.25	25
M32x1.5	17.0	21.0	21.0	25.5	36	28	13	F1100.32	25
M40x1.5	24.0	28.5	28.5	33.0	46	31	13	F1100.40	10
M50x1.5	33.0	37.0	37.0	42.0	55	34	14	F1100.50	10
M63x1.5	40.0	46.0	46.0	52.0	70	37	14	F1100.63	5
M75x1.5	50.0	56.0	56.0	63.0	80	38	15	F1100.75	1

Auf Anfrage lieferbar:
Anschlussgewinde Pg und NPT

Available on request:
Entry thread Pg and NPT



Kurzes Anschlussgewinde metrisch | Short entry thread metric

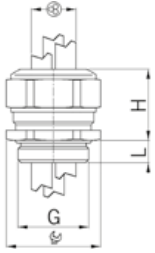

Material: Messing vernickelt
 Dichtung: Spezial AGRO TPE hellgrau
 O-Ring: NBR
 Zugentlastung: Ausführung A nach EN 62444
 Schutzart: IP 68
 Einsatztemperatur: -50 °C / +105 °C

Material: Nickel-plated brass
 Seal: Special AGRO TPE light grey
 O-ring: NBR
 Strain relief: Version A acc. to EN 62444
 Protection class: IP 68
 Operation temperature: -50 °C / +105 °C



Einteiliger Dichteinsatz
 nicht durchgehend isolierend

One-piece sealing insert
 not overall length insulated

G	$\begin{matrix} > \ominus < \\ \text{min mm} \end{matrix}$	$\begin{matrix} > \ominus < \\ \text{max mm} \end{matrix}$	$\begin{matrix} \text{⊗} \\ \text{mm} \end{matrix}$	$\begin{matrix} \text{⊕} \\ \text{mm} \end{matrix}$	H mm	L mm	Art.-No.	
M16x1.5	2.0	3.0	2	18	22	5	F1310.17.2.030	50
M16x1.5	2.5	4.0	2	18	22	5	F1310.17.2.040	50
M16x1.5	3.5	5.0	2	18	22	5	F1310.17.2.050	50
M20x1.5	3.5	5.0	2	24	23	6	F1310.20.2.050	50
M20x1.5	4.5	6.0	2	24	23	6	F1310.20.2.060	50
M20x1.5	5.5	7.5	2	24	23	6	F1310.20.2.075	50
M20x1.5	3.5	5.0	3	24	23	6	F1310.20.3.050	50
M20x1.5	4.5	6.0	3	24	23	6	F1310.20.3.060	50
M20x1.5	5.2	6.5	3	24	23	6	F1310.20.3.065	50
M20x1.5	3.5	5.0	4	24	23	6	F1310.20.4.050	50
M20x1.5	4.5	6.0	4	24	23	6	F1310.20.4.060	50
M25x1.5	5.0	7.0	2	30	28	7	F1310.25.2.070	25
M25x1.5	6.7	9.0	2	30	28	7	F1310.25.2.090	25
M25x1.5	7.7	10.0	2	30	28	7	F1310.25.2.100	25
M25x1.5	5.5	7.0	3	30	28	7	F1310.25.3.070	25
M25x1.5	6.8	9.0	3	30	28	7	F1310.25.3.090	25
M25x1.5	5.5	7.0	4	30	28	7	F1310.25.4.070	25
M25x1.5	4.8	6.0	6	30	28	7	F1310.25.6.060	25
M32x1.5	9.0	11.5	2	36	28	8	F1310.32.2.115	25
M32x1.5	7.0	9.0	3	36	28	8	F1310.32.3.090	25
M32x1.5	8.5	10.5	3	36	28	8	F1310.32.3.105	25
M32x1.5	7.0	9.0	4	36	28	8	F1310.32.4.090	25
M32x1.5	5.8	7.0	6	36	28	8	F1310.32.6.070	25

Weitere Ausführungen und Anschlussgewinde
 auf Anfrage

Further versions and entry threads
 are available upon request.

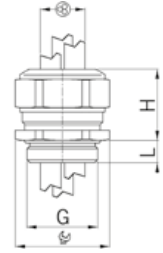

Langes Anschlussgewinde metrisch | Long entry thread metric

Material:	Messing vernickelt	Material:	Nickel-plated brass
Dichtung:	Spezial AGRO TPE hellgrau	Seal:	Special AGRO TPE light grey
O-Ring:	NBR	O-ring:	NBR
Zugentlastung:	Ausführung A nach EN 62444	Strain relief:	Version A acc. to EN 62444
Schutzart:	IP 68	Protection class:	IP 68
Einsatztemperatur:	-50 °C / +105 °C	Operation temperature:	-50 °C / +105 °C



Einteiliger Dichteinsatz
 nicht durchgehend isolierend

One-piece sealing insert
 not overall length insulated

G	$\begin{matrix} > \ominus < \\ \text{min mm} \end{matrix}$	$\begin{matrix} > \ominus < \\ \text{max mm} \end{matrix}$			H mm	L mm	Art.-No.	
M16x1.5	2.0	3.0	2	18	22	10	F1311.17.2.030	50
M16x1.5	2.5	4.0	2	18	22	10	F1311.17.2.040	50
M16x1.5	3.5	5.0	2	18	22	10	F1311.17.2.050	50
M20x1.5	3.5	5.0	2	24	23	10	F1311.20.2.050	50
M20x1.5	4.5	6.0	2	24	23	10	F1311.20.2.060	50
M20x1.5	5.5	7.5	2	24	23	10	F1311.20.2.075	50
M20x1.5	3.5	5.0	3	24	23	10	F1311.20.3.050	50
M20x1.5	4.5	6.0	3	24	23	10	F1311.20.3.060	50
M20x1.5	5.2	6.5	3	24	23	10	F1311.20.3.065	50
M20x1.5	3.5	5.0	4	24	23	10	F1311.20.4.050	50
M20x1.5	4.5	6.0	4	24	23	10	F1311.20.4.060	50
M25x1.5	5.0	7.0	2	30	28	11	F1311.25.2.070	25
M25x1.5	6.7	9.0	2	30	28	11	F1311.25.2.090	25
M25x1.5	7.7	10.0	2	30	28	11	F1311.25.2.100	25
M25x1.5	5.5	7.0	3	30	28	11	F1311.25.3.070	25
M25x1.5	6.8	9.0	3	30	28	11	F1311.25.3.090	25
M25x1.5	5.5	7.0	4	30	28	11	F1311.25.4.070	25
M25x1.5	4.8	6.0	6	30	28	11	F1311.25.6.060	25
M32x1.5	9.0	11.5	2	36	28	13	F1311.32.2.115	25
M32x1.5	7.0	9.0	3	36	28	13	F1311.32.3.090	25
M32x1.5	8.5	10.5	3	36	28	13	F1311.32.3.105	25
M32x1.5	7.0	9.0	4	36	28	13	F1311.32.4.090	25
M32x1.5	5.8	7.0	6	36	28	13	F1311.32.6.070	25



Weitere Ausführungen und Anschlussgewinde
 auf Anfrage

>Further versions and entry threads
 are available upon request.

Kurzes Anschlussgewinde metrisch | Short entry thread metric

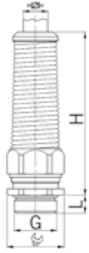

Material: Messing vernickelt
 Knickschutzfeder: Rostfreier Stahl A2
 Dichtung: Spezial AGRO TPE hellgrau
 O-Ring: NBR
 Zugentlastung: Ausführung A nach EN 62444
 Schutzart: IP 68 (bis 10 bar) / IP 69
 Einsatztemperatur: -50 °C / +105 °C

Material: Nickel-plated brass
 Antikink spring: Stainless steel A2
 Seal: Special AGRO TPE light grey
 O-ring: NBR
 Strain relief: Version A acc. to EN 62444
 Protection class: IP 68 (up to 10 bar) / IP 69
 Operation temperature: -50 °C / +105 °C



Einteiliger Dichteinsatz durchgehend isolierend

One-piece sealing insert overall length insulated

G	> Ø <	> Ø <	mm	H	L	i	Art.-No.	
	min mm	max mm		mm	mm	info		
M8x1.25	2.5	3.0	11	49	5	1	F1060.08.52.030	10
M8x1.25	3.5	4.0	11	49	5	1	F1060.08.52.040	10
M10x1.5	3.0	4.0	13	52	5	1	F1060.10.52.040	10
M10x1.5	4.0	6.0	13	52	5	1	F1060.10.52.060	10
M12x1.5	3.5	5.0	15	57	5	-	F1060.12.52.050	10
M12x1.5	5.0	6.5	15	57	5	-	F1060.12.52.065	10
M12x1.5	6.5	7.5	15	57	5	-	F1060.12.52.075	10
M16x1.5	4.5	6.0	18	66	5	-	F1060.17.52.060	10
M16x1.5	6.0	8.0	18	66	5	-	F1060.17.52.080	10
M16x1.5	8.0	10.5	18	66	5	-	F1060.17.52.105	10
M20x1.5	6.0	8.0	24	86	6	-	F1060.20.52.080	10
M20x1.5	8.0	11.0	24	86	6	-	F1060.20.52.110	10
M20x1.5	11.0	14.5	24	86	6	-	F1060.20.52.145	10
M25x1.5	9.5	12.5	30	99	7	-	F1060.25.52.125	10
M25x1.5	12.5	16.0	30	99	7	-	F1060.25.52.160	10
M25x1.5	16.0	19.0	30	99	7	-	F1060.25.52.190	10
M32x1.5	17.0	21.0	36	109	8	-	F1060.32.52.210	5
M32x1.5	21.0	24.5	36	109	8	-	F1060.32.52.245	5

1 = Metrisches Regelgewinde (mit VDE Testreport)
 Auf Anfrage lieferbar:
 - Kurzes Anschlussgewinde mit kurzem ein- oder zweiseitigem Dichteinsatz.
 - Langes Anschlussgewinde mit kurzem oder durchgehend isolierendem ein- oder zweiseitigem Dichteinsatz.

1 = Metric coarse-pitch thread (with VDE test report)
 Available on request:
 - Short entry thread with short one-piece or two-piece sealing insert.
 - Long entry thread with short or full-length insulating one-piece or two-piece sealing insert.

Kurzes Anschlussgewinde metrisch | Short entry thread metric

Material:	Messing vernickelt	Material:	Nickel-plated brass
Klemmschrauben:	Rostfreier Stahl A2	Screws:	Stainless steel A2
Dichtung:	Spezial AGRO TPE hellgrau	Seal:	Special AGRO TPE light grey
O-Ring:	NBR	O-ring:	NBR
Zugentlastung:	Ausführung B nach EN 62444	Strain relief:	Version B acc. to EN 62444
Schutzart:	IP 68 (bis 10 bar) / IP 69	Protection class:	IP 68 (up to 10 bar) / IP 69
Einsatztemperatur:	-50 °C / +105 °C	Operation temperature:	-50 °C / +105 °C

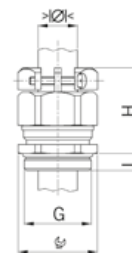

Einteiliger Dichteinsatz
nicht durchgehend isolierend

One-piece sealing insert
not overall length insulated

G	$\begin{matrix} > \ominus < \\ \text{min mm} & \text{max mm} \end{matrix}$	$\begin{matrix} > \ominus < \\ \text{min mm} & \text{max mm} \end{matrix}$	$\begin{matrix} \text{mm} \\ \text{mm} \end{matrix}$	H	L	i	Art.-No.	
M10x1.5	3.0	4.0	13/16	24	5	1	F1800.10.03.040	50
M10x1.5	4.0	6.0	13/16	24	5	1	F1800.10.03.060	50
M12x1.5	5.0	6.5	15/16	26	5	-	F1800.12.03.065	50
M12x1.5	6.5	8.0	15/16	26	5	-	F1800.12.03.080	50

1 = Metrisches Regelgewinde (mit VDE Testreport)

1 = Metric coarse-pitch thread (with VDE test report)



Zweiteiliger Dichteinsatz
nicht durchgehend isolierend

Two-piece sealing insert
not overall length insulated

G	$\begin{matrix} > \ominus < \\ \text{min mm} & \text{max mm} \end{matrix}$	$\begin{matrix} > \ominus < \\ \text{min mm} & \text{max mm} \end{matrix}$	$\begin{matrix} > \ominus < \\ \text{min mm} & \text{max mm} \end{matrix}$	$\begin{matrix} > \ominus < \\ \text{min mm} & \text{max mm} \end{matrix}$	$\begin{matrix} \text{mm} \\ \text{mm} \end{matrix}$	H	L	Art.-No.	
M16x1.5	6.0	8.0	8.0	10.5	18/19	30	5	F1800.17.03.105	50
M20x1.5	8.0	11.0	11.0	15.0	24	31	6	F1800.20.03.150	50
M25x1.5	12.5	16.0	16.0	20.5	30	35	7	F1800.25.03.205	25
M32x1.5	17.0	21.0	21.0	25.5	36	40	8	F1800.32.03.255	25
M40x1.5	24.0	28.5	28.5	33	46	44	8	F1800.40.03.330	10
M50x1.5	33.0	37.0	37.0	42.0	55	49	9	F1800.50.03.410	10
M63x1.5	40.0	46.0	46.0	52.0	70	55	10	F1800.63.03.520	5
M75x1.5	50.0	56.0	56.0	63.0	80	56	11	F1800.75.03.630	1



Kurzes Anschlussgewinde metrisch | Short entry thread metric

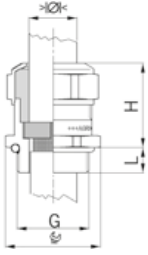

Material: Messing vernickelt
 Kontaktfeder: Federstahl 1.4310
 Dichtung: Spezial AGRO TPE hellgrau
 O-Ring: NBR
 Zugentlastung: Ausführung A nach EN 62444
 Schutzart: IP 68 (bis 10 bar) / IP 69
 Eigenschaften: Für zeitsparende und sichere Montage von partiell abisolierten sowie durchgehend geschirmten Kabeln
 Einsatztemperatur: -50 °C / +105 °C

Material: Nickel-plated brass
 Contact spring: Spring steel 1.4310
 Seal: Special AGRO TPE light grey
 O-ring: NBR
 Strain relief: Version A acc. to EN 62444
 Protection class: IP 68 (up to 10 bar) / IP 69
 Properties: For a quick and safe installation of partially dismantled cables as well as thoroughly shielded cables
 Operation temperature: -50 °C / +105 °C



Zweiteiliger Dichteinsatz
nicht durchgehend isolierend

Two-piece sealing insert
not overall length insulated

G	> Ø <	> Ø <	> Ø <	> Ø <	mm	H	L	i	Art.-No.	
	min mm	max mm	min mm	max mm	mm	mm	mm	info		
M12x1.5	-	-	3.5	5.0	15	22	5	1	F1083.12.050	50
M12x1.5	-	-	5.0	6.5	15	22	5	1	F1083.12.065	50
M16x1.5	6.0	8.0	8.0	10.5	18	25	5	-	F1083.17	50
M20x1.5	8.0	11.0	11.0	15.0	24	27	6	-	F1083.20	50
M25x1.5	12.5	16.0	16.0	20.5	30	33	7	-	F1083.25	25
M32x1.5	17.0	21.0	21.0	25.5	36	33	8	-	F1083.32	25
M40x1.5	24.0	28.5	28.5	33.0	46	38	8	-	F1083.40	10
M50x1.5	33.0	37.0	37.0	42.0	55	42	9	-	F1083.50	10
M63x1.5	40.0	46.0	46.0	52.0	70	42	10	-	F1083.63	5

1 = Einteiliger Dichteinsatz
 Auf Anfrage lieferbar:
 Anschlussgewinde Pg und NPT
 Ausführungen in Stahl A2 und A4

1 = One-piece sealing insert
 Available on request:
 Entry thread Pg and NPT
 Executions in steel A2 and A4

Langes Anschlussgewinde metrisch | Long entry thread metric



Zweiteiliger Dichteinsatz
nicht durchgehend isolierend

Two-piece sealing insert
not overall length insulated

G	> Ø <	> Ø <	> Ø <	> Ø <	mm	H	L	i	Art.-No.	
	min mm	max mm	min mm	max mm	mm	mm	mm	info		
M12x1.5	-	-	3.5	5.0	15	22	10	1	F1183.12.050	50
M12x1.5	-	-	5.0	6.5	15	22	10	1	F1183.12.065	50
M16x1.5	6.0	8.0	8.0	10.5	18	25	10	-	F1183.17	50
M20x1.5	8.0	11.0	11.0	15.0	24	27	10	-	F1183.20	50
M25x1.5	12.5	16.0	16.0	20.5	30	33	11	-	F1183.25	25
M32x1.5	17.0	21.0	21.0	25.5	36	33	13	-	F1183.32	25
M40x1.5	24.0	28.5	28.5	33.0	46	38	13	-	F1183.40	10
M50x1.5	33.0	37.0	37.0	42.0	55	42	14	-	F1183.50	10
M63x1.5	40.0	46.0	46.0	52.0	70	42	14	-	F1183.63	5

1 = Einteiliger Dichteinsatz
 Auf Anfrage lieferbar:
 Anschlussgewinde Pg und NPT
 Ausführungen in Stahl A2 und A4

1 = One-piece sealing insert
 Available on request:
 Entry thread Pg and NPT
 Executions in steel A2 and A4

Kurzes Anschlussgewinde metrisch | Short entry thread metric

Material:	Messing vernickelt	Material:	Nickel-plated brass
Dichtung:	Spezial AGRO TPE hellgrau	Seal:	Special AGRO TPE light grey
O-Ring:	NBR	O-ring:	NBR
Zugentlastung:	Ausführung A nach EN 62444	Strain relief:	Version A acc. to EN 62444
Schutzart:	IP 68 (bis 10 bar) / IP 69	Protection class:	IP 68 (up to 10 bar) / IP 69
Eigenschaften:	Für hohe Ableitströme, konzentrische Schirmkontaktierung 360° mit tiefstem Übergangswiderstand und Transferimpedanz. Sehr geringe Bauhöhe.	Properties:	For high leakage currents, concentric 360° shield contact ensure extremely low transfer resistance and transfer impedance. Compact design
Einsatztemperatur:	-50 °C / +105 °C	Operation temperature:	-50 °C / +105 °C

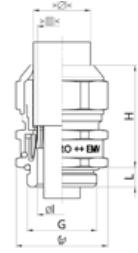

Zweiteiliger Dichteinsatz nicht durchgehend isolierend		Two-piece sealing insert not overall length insulated										
G	>∅< min mm	>∅< max mm	>∅< min mm	>∅< max mm	>■< mm	∅I mm	∅G mm	H mm	L mm	i info	Art.-No.	
M16x1.5	6.0	8.0	8.0	10.5	9.3	8.2	18	28	5	-	F1084.17	25
M20x1.5	8.0	11.0	11.0	15.0	13.4	11.9	24	32	6	-	F1084.20	25
M25x1.5	12.5	16.0	16.0	20.5	18.7	17.6	30	36.5	7	-	F1084.25	25
M32x1.5	17.0	21.0	21.0	25.5	23.8	22.1	36	38.5	8	-	F1084.32	25
M40x1.5	24.0	28.5	28.5	33.0	30.4	29.5	46	42	8	-	F1084.40	10
M50x1.5	33.0	37.0	37.0	42.0	38.7	37.7	55	44.5	9	-	F1084.50	10
M63x1.5	40.0	46.0	46.0	52.0	48.6	46.6	70	49	10	-	F1084.63	5
M75x1.5	50.0	56.0	56.0	63.0	59.7	57.9	80	51	11	-	F1084.75	1
M80x2.0	-	-	58.0	65.0	62.0	59.8	95	58	12	1	F1084.80.650	1
M85x2.0	-	-	63.0	70.0	67.0	64.7	95	58	12	1	F1084.85.700	1

1 = Einteiliger Dichteinsatz	1 = One-piece sealing insert
Auf Anfrage lieferbar:	Available on request:
Rostfreier Stahl A2 oder A4	Stainless steel A2 or A4
Anschlussgewinde Pg und NPT	Entry thread Pg and NPT



Langes Anschlussgewinde metrisch | Long entry thread metric

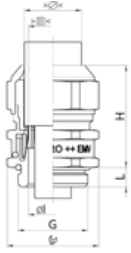

Material: Messing vernickelt
 Dichtung: Spezial AGRO TPE hellgrau
 O-Ring: NBR
 Zugentlastung: Ausführung A nach EN 62444
 Schutzart: IP 68 (bis 10 bar) / IP 69
 Eigenschaften: Für hohe Ableitströme, konzentrische Schirmkontaktierung 360° mit tiefstem Übergangswiderstand und Transferimpedanz. Sehr geringe Bauhöhe.
 Einsatztemperatur: -50 °C / +105 °C

Material: Nickel-plated brass
 Seal: Special AGRO TPE light grey
 O-ring: NBR
 Strain relief: Version A acc. to EN 62444
 Protection class: IP 68 (up to 10 bar) / IP 69
 Properties: For high leakage currents, concentric 360° shield contact ensure extremely low transfer resistance and transfer impedance. Compact design
 Operation temperature: -50 °C / +105 °C



Zweiteiliger Dichteinsatz
 nicht durchgehend isolierend

Two-piece sealing insert
 not overall length insulated

G	>⌀< min mm	>⌀< max mm	>⌀< min mm	>⌀< max mm	>■< mm	∅ mm	⌀ mm	H mm	L mm	i info	Art.-No.	
M16x1.5	6.0	8.0	8.0	10.5	9.3	8.2	18	28	10	-	F1184.17	25
M20x1.5	8.0	11.0	11.0	15.0	13.4	11.9	24	32	10	-	F1184.20	25
M25x1.5	12.5	16.0	16.0	20.5	18.7	17.6	30	36.5	11	-	F1184.25	25
M32x1.5	17.0	21.0	21.0	25.5	23.8	22.1	36	38.5	13	-	F1184.32	25
M40x1.5	24.0	28.5	28.5	33.0	30.4	29.5	46	42	13	-	F1184.40	10
M50x1.5	33.0	37.0	37.0	42.0	38.7	37.7	55	44.5	14	-	F1184.50	10
M63x1.5	40.0	46.0	46.0	52.0	48.6	46.6	70	49	14	-	F1184.63	5
M75x1.5	50.0	56.0	56.0	63.0	59.7	57.9	80	51	15	-	F1184.75	1
M80x2.0	-	-	58.0	65.0	62.0	59.8	95	58	18	1	F1184.80.650	1
M85x2.0	-	-	63.0	70.0	67.0	64.7	95	58	18	1	F1184.85.700	1

1 = Einteiliger Dichteinsatz
 Auf Anfrage lieferbar:
 Rostfreier Stahl A2 oder A4
 Anschlussgewinde Pg und NPT

1 = One-piece sealing insert
 Available on request:
 Stainless steel A2 or A4
 Entry thread Pg and NPT

Anschlussgewinde metrisch | Entry thread metric

Material:	Messing vernickelt	Material:	Nickel-plated brass
Dichtung:	Spezial AGRO TPE hellgrau	Seal:	Special AGRO TPE light grey
O-Ring:	NBR	O-ring:	NBR
Zugentlastung:	Ausführung A nach EN 62444	Strain relief:	Version A acc. to EN 62444
Schutzart:	IP 68 (bis 10 bar) / IP 69	Protection class:	IP 68 (up to 10 bar) / IP 69
Eigenschaften:	Für hohe Ableitströme, konzentrische Schirmkontaktierung mit tiefsten Übergangswiderständen und Transferimpedanzen	Properties:	For high leakage currents, concentric shield contact with minimal transfer resistances and transfer impedances
Einsatztemperatur:	-50 °C / +105 °C	Operation temperature:	-50 °C / +105 °C

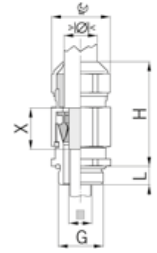

Zweiteiliger Dichteinsatz nicht durchgehend isolierend

Two-piece sealing insert not overall length insulated

G	> ◊ <	> ◊ <	> ◊ <	> ◊ <	> ■ <	mm	H	L	X	Art.-No.	mm
	min mm	max mm	min mm	max mm	mm		mm	mm	mm		
M16x1.5	-	-	4.5	6.0	3.0-4.5	18	40	6	14	F1000.17.85.045	25
M16x1.5	6.0	8.0	8.0	10.5	4.5-8.0	18	42	8	16	F1000.17.85.080	25
M16x1.5	8.0	11.0	11.0	15.0	7.5-10.0	24	47	8	20	F1000.17.85.100	25
M20x1.5	8.0	11.0	11.0	15.0	7.5-12.0	24	47	8	20	F1000.20.85.120	25
M20x1.5	12.5	16.0	16.0	20.5	10.0-14.0	30	59	8	21	F1000.20.85.140	20
M25x1.5	12.5	16.0	16.0	20.5	10.0-16.0	30	59	8	21	F1000.25.85.160	20
M25x1.5	17.0	21.0	21.0	25.5	14.0-19.0	36	66	8	24	F1000.25.85.190	25
M32x1.5	17.0	21.0	21.0	25.5	14.0-22.0	36	66	10	24	F1000.32.85.220	25
M32x1.5	24.0	28.5	28.5	33.0	21.0-25.0	46	68	10	24	F1000.32.85.250	5
M40x1.5	24.0	28.5	28.5	33.0	21.0-30.0	46	68	12	24	F1000.40.85.300	5
M50x1.5	33.0	37.0	37.0	42.0	29.0-38.0	55	82	13	30	F1000.50.85.380	5
M63x1.5	33.0	37.0	37.0	42.0	29.0-38.0	70/55	82	15	30	F1000.63.85.380	5
M63x1.5	40.0	46.0	46.0	52.0	35.0-44.0	70	78	15	26	F1000.63.85.440	1



Wichtig: Um den Kabelschirm und die Kabellitzen optimal zu schützen ist es erforderlich, das der Kabelverschraubung beiliegende Kupfer-EMV-Tape zu montieren.

Important: To provide the best possible protection for the cable shield and the cable, it is necessary to install a copper EMC tape.

Das Kupfer-Tape muss zwingend gemäss Illustration montiert werden! (Beispiel: Tape Scotch 3M Typ 1181)

The copper tape must be fixed according to the illustration! (example: Tape Scotch 3M Typ 1181)

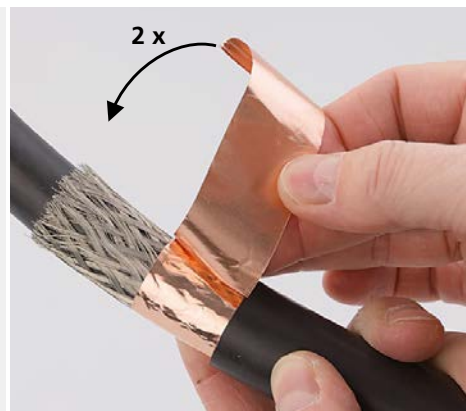

Ex Kabelverschraubungen

Ex cable glands

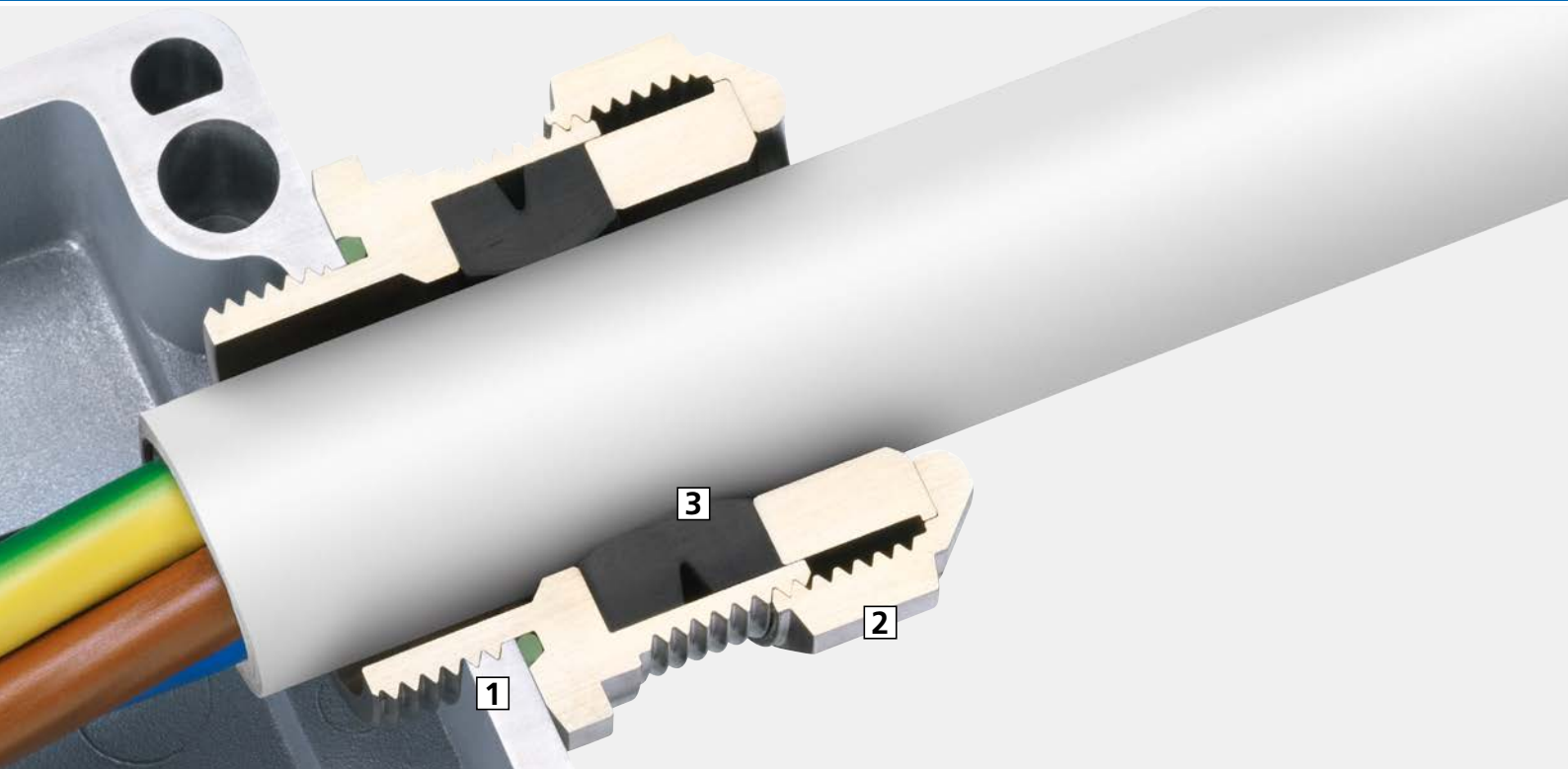

In vielen Bereichen wie zum Beispiel der Chemischen Industrie, Lackierereien, Offshore, Raffinerien, Tankstellen, Textil- und Papierindustrie, Nahrungsmittelindustrie, Glas- und/oder Keramikindustrie, Holzverarbeitung und in vielen weiteren Industrien, werden Geräte in explosionsgefährdeten Bereichen betrieben. Aufgrund der hohen Gefährdung von Personen sowie Sachwerten im Falle einer Explosion gelten speziell in explosionsgefährdeten Bereichen besonders strenge rechtliche und technische Anforderungen. AGRO Ex-Kabelverschraubungen aus Messing oder Kunststoff erfüllen die strengsten Anforderungen und sorgen in explosionsgefährdeten Bereichen für eine sichere Kabeleinführung. Alle Kabelverschraubungen sind zertifiziert und haben eine entsprechende EU-Baumusterprüfbescheinigung. Durch die IECEx-Zertifizierung ist ein weltweiter Einsatz möglich.

1 Kurze, lange oder Spezial-Anschlussgewinde

Ex Kabelverschraubungen Progress® mit kurzem oder langem Anschlussgewinde in metrischer, Pg-, Gasrohr- oder NPT-Ausführung können bei vorhandenem Gewinde oder Durchgangsbohrung mit Gegenmutter verwendet werden.

2 Stabile Schlüsselflächen

Grosse, stabile Schlüsselflächen an der Druckmutter vereinfachen das Anziehen mit dem Montagewerkzeug.

3 Garantierte Dichtigkeit

Auf den Dichteinsatz abgestimmte Innenkonturen sorgen für eine zielgerichtete Verformung des Dichteinsatzes und garantieren somit dessen perfekte Abdichtung. Die Schutzarten IP 68 bis 10 bar (druckfeste Kapselung 30 bar) sowie IP 69 ermöglichen eine breite Anwendung.

In many areas such as the chemical industry, paint shops, the offshore industry, refineries, petrol stations, the textile and paper industry, the food industry, the glass and/or ceramics industry, wood processing and many other industries, equipment is operated in explosive areas. Due to the high risk to persons and property in case of an explosion, very strict legal and technical requirements apply to explosive areas in particular. AGRO Ex cable glands made of brass or plastic comply with the strictest requirements and ensure safe cable entry in explosive areas. All cable glands are certified accordingly and come with an EC type-examination certificate. IECEx certification allows for worldwide use.

1 Short, long or special entry thread

Ex Cable glands Progress® with short or long entry thread designed as metric, Pg, gas-pipe or NPT can be used with existing opening threads or with a counter nut.



















2 Stable spanner flats

Large, stable spanner flats on the nut simplify tightening using the assembly tool.

3 Reliable leak-tightness

Inner contours matched to the sealing insert ensure a targeted deformation of the insert and thus ensure its leak-tightness in compliance with protection class IP 68 up to 10 bar (flameproof enclosures up to 30 bar) and IP 69 for a wide range of applications.



AGRO Ex Kabelverschraubungen Messing druckfeste Kapselung Ex d IIC AGRO Ex cable glands nickel-plated brass for flameproof enclosure Ex d IIC		147 - 148	1
AGRO Kabelverschraubungen Ex Compact Messing druckfeste Kapselung Ex d IIC und erhöhte Sicherheit Ex e II AGRO cable glands Ex Compact nickel-plated brass flameproof enclosure Ex d IIC and increased safety Ex e II		149	2
AGRO Kabelverschraubungen Ex Compact Messing mit Klemmbacken Ex d IIC und Ex e II AGRO cable glands Ex Compact nickel-plated brass with clamps Ex d IIC and Ex e II		150	3
AGRO Kabelverschraubungen Ex Compact Messing druckfeste Kapselung Ex d IIC und erhöhte Sicherheit Ex e II AGRO cable glands Ex Compact nickel-plated brass flameproof enclosure Ex d IIC and increased safety Ex e II		151	3
Verschlusschrauben Messing druckfeste Kapselung Ex d IIC Locking plugs nickel-plated brass flameproof enclosure Ex d IIC		152	4
AGRO Kabelverschraubungen Progress® Messing erhöhte Sicherheit Ex e II AGRO cable glands Progress® nickel-plated brass increased safety Ex e II		153 - 156	5
AGRO Kabelverschraubungen Progress® Messing erhöhte Sicherheit Ex e II für mehrere Kabel AGRO cable glands Progress® nickel-plated brass increased safety Ex e II for installation of multiple cables		157 - 158	6
AGRO Kabelverschraubungen Progress® Messing mit Klemmbacken erhöhte Sicherheit Ex e II AGRO cable glands Progress® nickel-plated brass with clamps increased safety Ex e II		159 - 160	6
AGRO Kabelverschraubungen Progress® Messing mit Trompete und Klemmbacken erhöhte Sicherheit Ex e II AGRO cable glands Progress® nickel-plated brass with trumpet and clamps increased safety Ex e II		161 - 162	7
AGRO Kabelverschraubungen Progress® EMV Rapid Messing mit Kontaktscheibe erhöhte Sicherheit Ex e II AGRO cable glands Progress® EMC Rapid nickel-plated brass with contact disc increased safety EX e II		163	8
AGRO Kabelverschraubungen Progress® EMV Messing mit Kontakthülse erhöhte Sicherheit Ex e II AGRO EMC cable glands Progress® nickel-plated brass with contact sleeve increased safety Ex e II		164 - 165	9
AGRO Kabelverschraubungen Progress® EMV Messing mit Kontakthülse und Klemmbacken erhöhte Sicherheit Ex e II AGRO EMC cable glands Progress® nickel-plated brass with contact sleeve and clamps increased safety Ex e II		166 - 167	9
AGRO Kabelverschraubungen Progress® EMV easyCONNECT mit Klemmbacken erhöhte Sicherheit Ex e II AGRO cable glands Progress® EMC easyCONNECT with clamps increased safety Ex e II		168	10
AGRO Kombi-Schlauchverschraubungen Progress® Messing erhöhte Sicherheit Ex e II AGRO combination conduit glands Progress® nickel-plated brass increased safety Ex e II		169	11
Verschlussbolzen Messing vernickelt Locking pins nickel-plated brass		170	12
AGRO Kabelverschraubungen Progress® Kunststoff GFK erhöhte Sicherheit Ex e II AGRO synthetic cable glands Progress® GFK increased safety Ex e II		171 - 174	12
AGRO Kabelverschraubungen Progress® Kunststoff GFK erhöhte Sicherheit Ex e II für mehrere Kabel AGRO synthetic cable glands Progress® GFK for increased safety Ex e II with sealing insert for multiple cables		175 - 177	13
AGRO Kabelverschraubungen Progress® Kunststoff GFK erhöhte Sicherheit Ex e II und Eigensicherheit Ex i II AGRO synthetic cable glands Progress® GFK increased safety Ex e II and intrinsic safety Ex i II		178 - 179	14
Reduktionen Messing erhöhte Sicherheit Ex e II Reduction fittings nickel-plated brass increased safety Ex e II		180 - 185	15

Richtlinien & Vorschriften

Richtlinie 2014/34/EU

Die Richtlinie 2014/34/EU des Europäischen Parlamentes und des Rates vom 26. Februar 2014 zur Harmonisierung der Rechtsvorschriften dient als Basis, welche für Hersteller und Benutzer von Geräten oder Schutzsystemen für den Einsatz in explosionsgefährdeten Bereichen verbindlich ist.

Seit dem 20.04.2016 dürfen nur noch Produkte gemäss den neuen Richtlinien und entsprechender EU-Konformitätserklärung auf den Markt gebracht werden. Zertifikate nach Richtlinie 94/9/EG behalten ihre Gültigkeit. Eine Neuzertifizierung nach den aktuellen Richtlinien 2014/34/EU ist nicht erforderlich.

Die Richtlinie 2014/34/EU definiert im Anhang verschiedene Module für die Inverkehrbringung von Geräten für den Einsatz in explosionsgefährdeten Bereichen. Oft verwendet, so auch bei AGRO, werden die Module B (Anhang III) und D (Anhang IV), woraus folgende Zertifikate resultieren:

- Die EU-Baumusterprüfbescheinigung
- Die Anerkennung Qualitätssicherung Produktion

Beide Zertifikate werden von akkreditierten Prüfstellen nach erfolgreich absolvierten Prüfungen/Audits ausgestellt.

EU-Baumusterprüfbescheinigung

Modul B regelt die EU-Baumusterprüfung. Darauf basiert die EU-Baumusterprüfbescheinigung. Sie wird auf Grund der erfolgreichen technischen Produkteprüfungen ausgestellt.

Anerkennung Qualitätssicherung Produktion

Modul D fordert die geprüfte und überwachte Produktion. Sie stellt sicher, dass die in Verkehr gebrachten Produkte mit den Prüfmustern der EU-Baumusterprüfbescheinigung übereinstimmen. Ein vorhandenes QM-System wird nach EN/ISO/IEC 80079-34 geprüft und zertifiziert.

EU-Konformitätserklärung

Die EU-Konformitätserklärung basiert auf der EU-Baumusterprüfbescheinigung und der Mitteilung Qualitätssicherung Produktion. Damit erklärt der Hersteller die Einhaltung der geltenden Normen, Richtlinien und Vorschriften. Sichtbar wird dies durch die CE-Kennzeichnung.

Installation

 **Für das Errichten und Betreiben sind die Vorschriften gemäss IEC / EN 60079-14, das Gerätesicherheitsgesetz, die allgemein anerkannten Regeln der Technik und die Betriebsanleitung massgebend. Damit der geforderte IP-Schutzgrad gemäss EN 60529:2014 erreicht wird, müssen die Verschraubungen sachgerecht im elektrischen Betriebsmittel eingebaut werden.**

Bei Montage von Erweiterungen oder Reduktionen ist darauf zu achten, dass maximal 1 Stk. eingebaut wird. Das Ineinanderschrauben mehrerer Reduktionen / Erweiterungen ist nach Norm nicht zulässig!

Bitte beachten Sie unbedingt unsere Montage-, Betriebs- und Wartungsanleitungen!

Beim Einsatz in Kunststoffgehäuse müssen die Kabelverschraubungen in den Potentialausgleich einbezogen werden. Die auf der Tabelle für die jeweiligen Grössen angegebenen Anzugsdrehmomente für die Druckmuttern und die Klemmbackenschrauben sowie die ergänzenden Hinweise sind zu beachten.

Instandhaltung

 **Die für Wartung, Instandhaltung und Prüfung geltenden Bestimmungen der IEC / EN 60079-14 sind einzuhalten. Im Rahmen der Wartung sind vor allem die für die Zündschutzart massgebenden Teile zu prüfen.**

Directives & Regulations

Directive 2014/34/EU

Directive 2014/34/EU of the European Parliament and Council of 26 February 2014 on the harmonisation of the laws of the Member States serves as a mandatory basis for manufacturers and users of equipment and protective systems for use in potentially explosive atmospheres.

Since 20 April 2016 only products approved according to the new directive and with an EC declaration of conformity can be brought to the market. Old certificates according to the former Directive 94/9/EC remain valid. A recertification according to Directive 2014/34/EU is not necessary.

In the annex of Directive 2014/34/EU, various modules for the commercialisation of equipment intended for use in potentially explosive atmospheres are defined. Modules B (Annex III) and D (Annex IV) are often used, also by AGRO, and from them two certificates result:

- EU type-examination certificate
- Recognition of production quality assurance

Both certificates are issued by accredited testing facilities after tests/audits have been successfully completed.

EU type-examination certificate

The EU type-examination certificate is the document which is issued on the basis of successfully passed technical testing according to the requirements of Module B.

Recognition of production quality assurance

Module D demands tested and monitored production. It ensures that products placed on the market are identical with the test samples used for the EU type-examination certificate. The quality management system must be tested and certified acc. to EN/ISO/IEC 80079-34.

EU declaration of conformity

The EU declaration of conformity is based on the EU type-examination certificate and manufacturing approval. With it, a manufacturer declares that it has observed all applicable standards, instructions and regulations. This is visually indicated by the CE marking.

Installation

 **The regulations according to IEC / EN 60079-14, the equipment safety law, the generally acknowledged rules of the industry and the operating instructions are applicable for installation and operation. In order to ensure the required IP protection category according to EN 60529:2014 is achieved, the cable glands must be properly installed in the electrical equipment.**

When installing enlarging or reduction fittings, make sure to install one piece only. Standards do not permit the screwing together of reduction / enlarging fittings!

Please note: Our installation, operation and maintenance guidelines must be observed!

When used in enclosures made of plastic, the cable glands must be included in the equipotential bonding system. The tightening torques stated in the table for the respective sizes of compression nuts and clamps and the additional information must be taken into account.

Maintenance

 **The provisions of IEC / EN 60079-14 which are applicable for service, maintenance and testing must be complied with. During maintenance, in particular the parts critical for the ignition protection category must be examined.**

In Produktions- und Arbeitsstätten können sich Gefahrenbereiche für Explosionen ausbilden, wenn die ersten zwei Voraussetzungen für eine Explosion erfüllt sind. Typische Gefahrenbereiche entstehen in chemischen Fabriken, Raffinerien, Lackfabriken, Lackierereien, Reinigungsanlagen, Mühlen und Lagern für Mahlprodukte, Grossbäckereien und anderen brennbaren Stäuben, in Tank- und Verladeanlagen für brennbare Gase, Flüssigkeiten und Feststoffe.

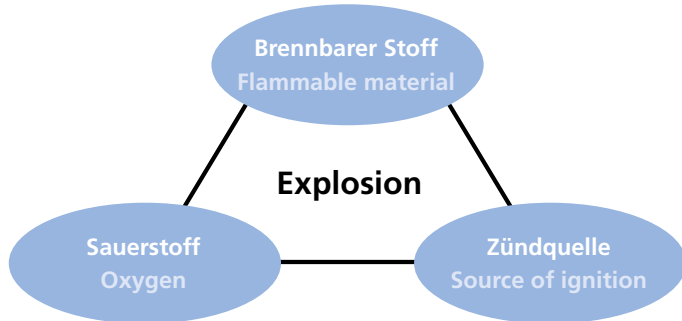

In production and work places, explosive areas may arise when the preconditions for an explosion, as shown in the illustration below, are met. Typical danger zones arise in chemical factories, refineries, paint and varnish factories, paint shops, cleaning plants, mills and storehouses for mill products, large bakeries and other flammable dusts, in tank and loading facilities for inflammable gases, liquids and solid matter.

Beispiele für Zoneneinteilungen im Ex-Bereich

Examples for zone classifications in hazardous (Ex) areas

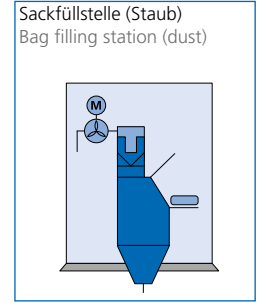
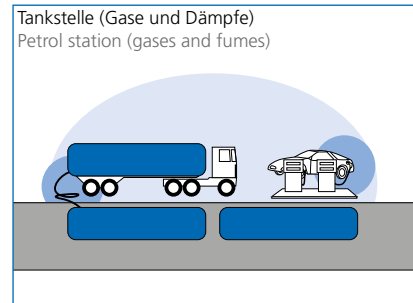

■ Zone 0
■ Zone 1
■ Zone 2

■ Zone 20
■ Zone 21
■ Zone 22

Weiterhin spielt für das Entstehen einer Explosion die Konstellation dieser Faktoren eine Rolle. So kann z.B. eine übersättigte Atmosphäre nicht zünden (Gemisch zu fett) ebenso eine Atmosphäre mit zu hohem Sauerstoffanteil (Gemisch zu mager).

Furthermore, for an explosion to occur, the combination of these factors is important. If the atmosphere is oversaturated (rich mixture) it cannot ignite, nor can it if the oxygen content is too high (lean mixture).

Die Gerätekennzeichnung – unterschieden durch Buchstaben – sagt etwas über die explosionsfähigen Stoffe aus:

The marking of devices, using letters, gives information about the flammable material:

- M** vorangestellt steht für untertägige Bergwerke
- G** nachgestellt steht für brennbare Gase, Nebel oder Dämpfe und
- D** nachgestellt für Stäube

- M** mining
- G** flammable gas, vapour, fumes
- D** dust

Die Ziffern drücken den Grad aus.

Numbers are used to indicate the degree of safety.

- 1** steht für ein sehr hohes Mass an Sicherheit
- 2** steht für ein hohes Mass an Sicherheit
- 3** steht für ein normales Mass an Sicherheit

- 1** very high degree of safety
- 2** high degree of safety
- 3** normal degree of safety

Damit ergibt sich die Zuordnung der Gerätekategorien zu den Zonen.

The outcome of this is the assignment of the device categories to the zones.

Die Definition der Ex-Zonen und der Zusammenhang der explosionsgefährdeten Bereiche mit der Häufigkeit der Zündquellen im Übertagebetrieb.

The definition of the hazardous area and the combination between explosive areas and frequency by sources of ignition (no mining)

Zoneneinteilung / Zoning						
	Gas / Gas			Staub / Dust		
	Zone 0	Zone 1	Zone 2	Zone 20	Zone 21	Zone 22
Häufigkeit der Explosionsgefahr	ständig oder langfristig	gelegentlich	selten und kurzfristig	wie Zone 0 Staubablagerungen allein bilden keine Zone 20	wie Zone 1	wie Zone 2 oder wenn Staubanhäufungen vorhanden sind
Frequency of explosion risk	constant or long-term	occasional	rare and for a short time	Like zone 0 Dust deposits alone are not sufficient for Zone 20 to apply	like Zone 1	like Zone 2 or if dust deposits are present
Häufigkeit der Zündquellen von elektrischen Betriebsmitteln	niemals (auch nicht bei seltenen Betriebsstörungen)	sehr selten (auch nicht bei häufiger zu erwartenden Betriebsstörungen)	gelegentlich (z.B. bei Betriebsstörung)	wie Zone 0	wie Zone 1	wie Zone 2
Frequency of sources of ignition from electrical equipment	never (also not on rare malfunctions)	very rare (also not in the case of more frequently expected malfunctions)	occasional (e.g. during malfunctions)	like Zone 0	like Zone 1	like Zone 2

Generelle Informationen Explosionsschutz

Information about explosion protection

Gerätezuordnung nach Zonen Device assignment by zones			
Gruppe Group	Stufe Explosionsgefahr Level of explosion risk	Erforderliche Kennzeichnung der einsetzbaren Betriebsmittel Required marking of applicable equipment	
		Gerätegruppe* Device group*	Kategorie Category
Gruppe II Group II	Zone 0	II	1 G
Gruppe II Group II	Zone 1	II	2 G oder / or 1 G
Gruppe II Group II	Zone 2	II	3 G oder / or 2 G
Gruppe III Group III	Zone 20	III	1 D
Gruppe III Group III	Zone 21	III	2 D oder / or 1 D
Gruppe III Group III	Zone 22	III	3 D oder / or 2 D

* Die Geräte werden in zwei Gruppen unterteilt. Gruppe 1 gilt für schlagwettergefährdete Geräte zur Verwendung im Bergbau und wird hier nicht weiter beschrieben.
* The equipment is divided into two groups. Group 1 is applicable to equipment at risk from firedamp and intended for use in mining and will not be described further here.



Für elektrische Betriebsmittel der Gruppe II wird weiter eine Unterteilung in Explosionsgruppen und Temperaturklassen vorgenommen.

For electrical equipment of Group II, further classifications in terms of temperature class and explosion group have been undertaken.

Einteilung in Temperaturklassen Classification by temperature class		
Zündtemperatur in °C Ignition temperature in °C	Temperaturklasse Temperature class	max. Oberflächentemperatur in °C des Betriebsmittels max. surface temperature of the equipment in °C
≥ 450	T1	450
300-450	T2	300
200-300	T3	200
135-200	T4	135
100-135	T5	100
85-100	T6	85



Einteilung von Explosionsgruppen bei Gas-Ex-Schutz

Brennbare Gase/Dämpfe/Nebel unterscheiden sich in ihrem Zünddurchschlagsvermögen. Daher unterteilt man sie in Explosionsgruppen. Durch Versuchsreihen wurde hierbei die Grenzspaltweite MESG (Maximum Experimental Safe Gap) und der Mindestzündstrom MIC (Minimum Ignition Current) ermittelt. Die Gefährlichkeit der Gase nimmt hierbei von IIA nach IIC zu.



Classification of explosion groups for gas protection

Flammable gases, fumes and vapours differ in their ignitability. Therefore they are classified in explosion groups. Testing established the MESG (Maximum Experimental Safe Gap) and the MIC (Minimum Ignition Current). The risk increases from IIA to IIC.

Explosionsgruppe Explosion Group	Grenzspaltwerte MESG Maximum experimental safe gap	Mindestzündstromverhältnis bezogen auf Methan Minimum ignition current relating to methane
II A	> 0.9 mm	> 0.8
II B	0.5 mm - 0.9 mm	0.45 - 0.8
II C	< 0.5 mm	< 0.45

Schematische Darstellung der Funktionsprinzipien von einzelnen Zündschutzarten für die AGRO Kabelverschraubungen anbietet.

Schematic representation of functional principle of some ignition protection types for which AGRO offers cable glands.

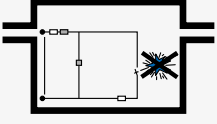
Zündschutzart nach IEC bzw. EN Type of ignition protection according to IEC / EN standards	Grundprinzip Basic principle	Schematische Darstellung Schematic representation
IEC / EN 60079-1	<p>Ex d druckfeste Kapselung</p> <p>Kommt es im Innern eines druckfest gekapselten Gehäuses zu einer Explosion wird eine Übertragung der Explosion nach aussen ausgeschlossen</p> <p>Ex d flameproof enclosures</p> <p>If an explosion occurs within a flameproof enclosure, the explosion will be contained within the enclosure</p>	
IEC / EN 60079-7	<p>Ex e erhöhte Sicherheit</p> <p>Die Entstehung von Funken und hohen Temperaturen wird mit einem erhöhten Grad an Sicherheit ausgeschlossen</p> <p>Ex e increased safety</p> <p>The appearance of sparks and high temperatures is prevented by an increased level of safety.</p>	
IEC / EN 60079-11	<p>Ex i Eigensicherheit</p> <p>Die Energie im Stromkreis wird so gering gehalten, dass zündfähige Funken, Lichtbögen oder hohe Temperaturen nicht entstehen können</p> <p>Ex i intrinsic safety</p> <p>The circuit energy is kept so low that ignitable sparks, electric arcs and high temperatures cannot arise</p>	



Anwendungen

Die AGRO Kabelverschraubungen für explosionsgeschützte Geräte sind somit für die meisten Anwendungen an explosionsgeschützten Motoren, Schalt- und Steuergeräten, Gehäusen usw. geeignet, die in der Industrie, in der chemischen und petrochemischen Industrie eingesetzt werden.



Applications

AGRO cable glands for explosion-protected equipment are therefore suitable for most applications in explosion-protected motors, switching and control devices, housings etc. used in industrial fields such as in the machinery and automation industry and in the chemical and petrochemical industry.

	Kabelverschraubung Messing Cable glands nickel-plated brass	Druckfeste Kapselung (Serie 18) Flameproof enclosure (Series 18)	Druckfeste Kapselung (Ex Compact) Progress® Messing (Ex Compact)	Standard Standard	Für mehrere Kabel For multiple cables	Mit Klemmbacken With clamps	Mit Trompete With trumpet shape and clamps	EMV EMC	Progress® Kunststoff (GFK) Standard	Für mehrere Kabel For multiple cables	Zubehör Accessories	Reduktoren Reducers	Erweiterungen Expanders	Adapter Adapters	Verschlusschrauben Locking screws
Ausführung / Design															
Kompressionstechnik Compression technology	•	•	•	•	•	•	•	•	•	•	-	-	-	-	-
Zündschutzart Type of protection	d	d/e	e	e	e	e	e	e	e/i	e/i	e	e	e	e	d/e
EMV Technik / EMC technology															
Kontakthülse / Scheibe Contact sleeve / disc	-	-	-	-	-	-	•	-	-	-	-	-	-	-	-
Kontaktfeder Contact spring	-	-	-	-	-	-	•	-	-	-	-	-	-	-	-
Gewinde / Thread															
Anschlussgewinde metrisch Entry thread metric	•	•	•	•	•	•	•	•	•	•	-	-	-	-	•
Anschlussgewinde Pg Entry thread Pg	•	-	•	•	•	•	•	•	•	•	-	-	-	-	•
Anschlussgewinde NPT Entry thread NPT	•	•	-	-	-	-	-	-	-	-	-	-	-	-	-
Anschlussgewinde Gasrohr Entry thread gas-pipe	•	-	-	-	-	-	-	-	-	-	-	-	-	-	-
Aussengewinde metrisch - Innengewinde metrisch External thread metric - internal thread metric	-	-	-	-	-	-	-	-	-	-	•	•	-	-	-
Aussengewinde Pg - Innengewinde metrisch External thread Pg - internal thread metric	-	-	-	-	-	-	-	-	-	-	-	-	•	-	-
Kurzes Anschlussgewinde Short entry thread	-	-	•	•	•	•	•	•	•	•	•	•	•	•	•
Langes Anschlussgewinde Long entry thread	•	•	•	-	-	•	-	-	-	-	-	-	-	-	-
Dichteinsatz / Sealing insert															
Einteiliger Dichteinsatz One-piece sealing insert	•	•	•	•	-	-	•	•	•	•	-	-	-	-	-
Zweiteiliger Dichteinsatz Two-piece sealing insert	-	-	-	-	•	•	-	-	-	-	-	-	-	-	-
Für mehrere Kabel For multiple cables	-	-	-	•	-	-	-	-	•	-	-	-	-	-	-
Standard-Dichteinsatz (TPE / NBR)	•	•	•	•	•	•	•	•	•	•	-	-	-	-	-
Standard sealing insert (TPE / NBR)	•	•	•	•	•	•	•	•	•	•	-	-	-	-	-
Technische Besonderheiten / Technical features															
Zugentlastung Strain relief	•	•	•	•	•	•	•	•	•	•	-	-	-	-	-
Mechanische Zugentlastung Mechanical strain relief	•	•	-	-	•	-	•	-	-	-	-	-	-	-	-
Mit Biegeschutz und mechanischer Zugentlastung With bending protection and mechanical strain relief	•	-	-	-	-	•	-	-	-	-	-	-	-	-	-

AGRO Ex Kabelverschraubungen Messing druckfeste Kapselung Ex d IIC

AGRO Ex cable glands nickel-plated brass for flameproof enclosure Ex d IIC

Anschlussgewinde metrisch | Entry thread metric

Material: Messing vernickelt
 Schrauben: Rostfreier Stahl A2
 Dichtung: NBR
 O-Ring: FPM
 Schutzart: IP 68 (30 bar)
 Prüfnorm: IEC EN 60079-0 /
 IEC EN 60079-1 /
 IEC EN 60079-31
 Gas: II 2G Ex db eb IIC
 Staub: II 2D Ex ta IIIC
 Zone: Gas 1 und 2 /
 Staub 21 und 22
 Zertifikat: PTB 00 ATEX 1059
 IECEx Zertifikat: IECEx PTB 12.0056
 Einsatztemperatur: -40 °C / +100 °C

Material: Nickel-plated brass
 Screws: Stainless steel A2
 Seal: NBR
 O-ring: FPM
 Protection class: IP 68 (30 bar)
 Test standard: IEC EN 60079-0 /
 IEC EN 60079-1 /
 IEC EN 60079-31
 Gas: II 2G Ex db eb IIC
 Dust: II 2D Ex ta IIIC
 Zone: Gas 1 and 2 /
 dust 21 and 22
 Certificate: PTB 00 ATEX 1059
 IECEx Certificate: IECEx PTB 12.0056
 Operation temperature: -40 °C / +100 °C

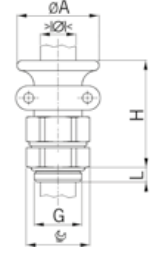

Einteiliger Dichteinsatz nicht durchgehend isolierend		One-piece sealing insert not overall length insulated					
G	>ØK min mm	>ØK max mm	ØA mm	H mm	L mm	Art.-No.	
M16x1.5	7.0	9.0	20	27	57	1817.09.26	20
M20x1.5	9.0	11.0	24	30	57	1820.11.26	20
M20x1.5	11.0	13.0	26	32	57	1820.16.26	20
M25x1.5	13.0	16.5	32	40	67	1825.21.26	10
M25x1.5	16.5	20.0	36	44	67	1825.21.27	10
M32x1.5	20.0	24.0	46	48	78	1832.29.26	5
M40x1.5	24.0	28.0	46	52	78	1840.29.27	5
M50x1.5	28.0	32.0	55	60	85	1850.36.26	5
M50x1.5	32.0	36.0	55	64	85	1850.36.27	5
M63x1.5	36.0	40.0	70	75	88	1863.48.26	1
M63x1.5	40.0	44.0	70	80	88	1863.48.27	1



Serie 18



Anschlussgewinde Pg | Entry thread Pg

Einteiliger Dichteinsatz nicht durchgehend isolierend		One-piece sealing insert not overall length insulated					
G	>ØK min mm	>ØK max mm	ØA mm	H mm	L mm	Art.-No.	
Pg 9	7.0	9.0	20	27	57	1809.26	20
Pg 11	9.0	11.0	24	30	57	1811.26	20
Pg 13	11.0	13.0	26	32	57	1813.26	20
Pg 16	11.0	13.0	26	32	57	1816.26	20
Pg 21	13.0	16.5	32	40	67	1821.26	10
Pg 21	16.5	20.0	36	44	67	1821.27	10
Pg 29	20.0	24.0	45	48	78	1829.26	5
Pg 29	24.0	28.0	45	52	78	1829.27	5
Pg 36	28.0	32.0	55	60	85	1836.26	5
Pg 36	32.0	36.0	55	64	85	1836.27	5
Pg 48	36.0	40.0	64	75	88	1848.48.26	1
Pg 48	40.0	44.0	64	80	88	1848.48.27	1



Serie 18



AGRO Ex Kabelverschraubungen Messing druckfeste Kapselung Ex d IIC

AGRO Ex cable glands nickel-plated brass for flameproof enclosure Ex d IIC

Anschlussgewinde NPT | Entry thread NPT

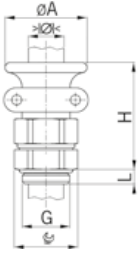

Material: Messing vernickelt
 Schrauben: Rostfreier Stahl A2
 Dichtung: NBR
 Schutzart: IP 68 (30 bar)
 Prüfnorm: IEC EN 60079-0 / IEC EN 60079-1 / IEC EN 60079-31
 Gas: II 2G Ex db eb IIC
 Staub: II 2D Ex ta IIIC
 Zone: Gas 1 und 2 / Staub 21 und 22
 Zertifikat: PTB 00 ATEX 1059
 IECEx Zertifikat: IECEx PTB 12.0056
 Einsatztemperatur: -40 °C / +100 °C

Material: Nickel-plated brass
 Screws: Stainless steel A2
 Seal: NBR
 Protection class: IP 68 (30 bar)
 Test standard: IEC EN 60079-0 / IEC EN 60079-1 / IEC EN 60079-31
 Gas: II 2G Ex db eb IIC
 Dust: II 2D Ex ta IIIC
 Zone: Gas 1 and 2 / dust 21 and 22
 Certificate: PTB 00 ATEX 1059
 IECEx Certificate: IECEx PTB 12.0056
 Operation temperature: -40 °C / +100 °C



Serie 18



Einteiliger Dichteinsatz
 nicht durchgehend isolierend

One-piece sealing insert
 not overall length insulated

G	> Ø < min mm	> Ø < max mm	mm	ØA mm	H mm	L mm	Art.-No.	
NPT 3/8"	7.0	9.0	20	27	57	15.5	183/8NPT.09.26	20
NPT 1/2"	9.0	11.0	24	30	57	20	181/2NPT.11.26	20
NPT 1/2"	11.0	13.0	26	32	57	20	181/2NPT.16.26	20
NPT 3/4"	9.0	11.0	27	30	57	20	183/4NPT.11.26	20
NPT 3/4"	11.0	13.0	26	32	57	20	183/4NPT.16.26	20
NPT 3/4"	13.0	16.5	32	40	67	20	183/4NPT.21.26	10
NPT 1"	13.0	16.5	32/34	40	67	25	181NPT.21.26	10
NPT 1"	16.5	20.0	36	44	67	25	181NPT.21.27	10
NPT 1 1/4"	20.0	24.0	45	48	78	26	1811/4NPT.29.26	5
NPT 1 1/4"	24.0	28.0	45	52	78	26	1811/4NPT.29.27	5
NPT 1 1/2"	28.0	32.0	55	60	85	26	1811/2NPT.36.26	5
NPT 1 1/2"	32.0	36.0	55	64	85	26	1811/2NPT.36.27	5

IP 68, wenn Anschlussgewinde abgedichtet

IP 68, if the entry thread is sealed

Anschlussgewinde Gasrohr | Gas-pipe entry thread



Serie 18



Einteiliger Dichteinsatz
 nicht durchgehend isolierend

One-piece sealing insert
 not overall length insulated

G	> Ø < min mm	> Ø < max mm	mm	ØA mm	H mm	L mm	Art.-No.	
G 3/8"	7.0	9.0	20	27	57	12	183/8G.09.26	20
G 1/2"	9.0	11.0	24	30	57	14	181/2G.11.26	20
G 1/2"	11.0	13.0	26	32	57	14	181/2G.16.26	20
G 3/4"	13.0	16.5	32	40	67	16	183/4G.21.26	10
G 3/4"	16.5	20.0	36	44	67	16	183/4G.21.27	10
G 1"	20.0	24.0	45	48	78	17	181G.29.26	5
G 1 1/4"	24.0	28.0	45	52	78	17	1811/4G.29.27	5
G 1 1/2"	28.0	32.0	55	60	85	17	1811/2G.36.26	5
G 2"	36.0	40.0	64	75	88	20	1848.26	1
G 2"	40.0	44.0	64	80	88	20	1848.27	1

Anschlussgewinde metrisch | Entry thread metric

Material: Messing vernickelt
 Dichtung: NBR
 O-Ring: FPM
 Schutzart: IP 66 / IP 68 (30 bar)
 Prüfnorm: IEC EN 60079-0 / IEC EN 60079-1 / IEC EN 60079-7 / IEC EN 60079-31
 Gas: II 2G Ex db eb IIC
 Staub: II 2D Ex ta IIIC
 Zone: Gas 1 und 2 / Staub 21 und 22
 Zertifikat: PTB 10 ATEX 1034X
 IECEx Zertifikat: IECEx PTB 12.0055X
 Einsatztemperatur: -60 °C / +105 °C

Material: Nickel-plated brass
 Seal: NBR
 O-ring: FPM
 Protection class: IP 66 / IP 68 (30 bar)
 Test standard: IEC EN 60079-0 / IEC EN 60079-1 / IEC EN 60079-7 / IEC EN 60079-31
 Gas: II 2G Ex db eb IIC
 Dust: II 2D Ex ta IIIC
 Zone: Gas 1 and 2 / dust 21 and 22
 Certificate: PTB 10 ATEX 1034X
 IECEx Certificate: IECEx PTB 12.0055X
 Operation temperature: -60 °C / +105 °C

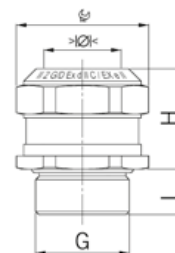

Einteiliger Dichteinsatz
 nicht durchgehend isolierend

One-piece sealing insert
 not overall length insulated

G	>math>\varnothing</math> min mm	>math>\varnothing</math> max mm	>math>\varnothing</math> mm	H mm	L mm	Art.-No.	
M16x1.5	3.0	7.0	21	26	12	EX1126.17.070	25
M16x1.5	5.0	10.0	24	26	12	EX1126.17.100	25
M20x1.5	5.0	11.0	24	26	12	EX1126.20.110	25
M20x1.5	9.0	14.0	30	26	12	EX1126.20.140	25
M25x1.5	7.5	15.0	32	28	12	EX1126.25.150	20
M25x1.5	12.5	18.0	32	28	12	EX1126.25.180	20
M32x1.5	17.0	23.0	41	33	12	EX1126.32.230	10
M32x1.5	21.0	26.0	41	33	12	EX1126.32.260	10
M40x1.5	21.0	26.0	41	33	14	EX1126.40.260	10
M40x1.5	24.0	32.0	50	34	14	EX1126.40.320	10
M50x1.5	28.0	36.0	55	34	14	EX1126.50.360	5
M50x1.5	35.0	42.0	60	35	14	EX1126.50.420	5
M63x1.5	36.0	44.0	65	35	14	EX1126.63.440	1
M63x1.5	43.0	50.0	70	35	14	EX1126.63.500	1

Auf Anfrage lieferbar:
 Rostfreier Stahl A2 oder A4

Available on request:
 Stainless steel A2 or A4



EX Compact MS



Anschlussgewinde metrisch | Entry thread metric

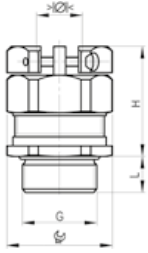

Material: Messing vernickelt
 Dichtung: NBR
 O-Ring: FPM
 Schutzart: IP 66 / IP 68 (30 bar)
 Prüfnorm: IEC EN 60079-0 / IEC EN 60079-1 / IEC EN 60079-7 / IEC EN 60079-31
 Gas: II 2G Ex db eb IIC Gb
 Staub: II 2D Ex tb IIIC Db
 Zone: Gas 1 und 2 / Staub 21 und 22
 Zertifikat: SEV 17 ATEX 0153
 IECEx Zertifikat: IECEx SEV 17.0017
 Einsatztemperatur: -60 °C / +105 °C

Material: Nickel-plated brass
 Seal: NBR
 O-ring: FPM
 Protection class: IP 66 / IP 68 (30 bar)
 Test standard: IEC EN 60079-0 / IEC EN 60079-1 / IEC EN 60079-7 / IEC EN 60079-31
 Gas: II 2G Ex db eb IIC Gb
 Dust: II 2D Ex tb IIIC Db
 Zone: Gas 1 and 2 / dust 21 and 22
 Certificate: SEV 17 ATEX 0153
 IECEx Certificate: IECEx SEV 17.0017
 Operation temperature: -60 °C / +105 °C



EX Compact MS KB



Einteiliger Dichteinsatz
 nicht durchgehend isolierend

One-piece sealing insert
 not overall length insulated

G	>Ø<		Ø	H	L	Art.-No.	📦
	min mm	max mm					
M16x1.5	3.0	7.0	21	34	12	EX1826.17.070	25
M16x1.5	5.0	10.0	24	35	12	EX1826.17.100	25
M20x1.5	5.0	11.0	24	35	12	EX1826.20.110	25
M20x1.5	9.0	14.0	30	35	12	EX1826.20.140	25
M25x1.5	7.5	15.0	32	37	12	EX1826.25.150	20
M25x1.5	12.5	18.0	32	37	12	EX1826.25.180	20
M32x1.5	17.0	23.0	41	42	12	EX1826.32.230	10
M32x1.5	21.0	26.0	41	42	12	EX1826.32.260	10
M40x1.5	21.0	26.0	41	42	14	EX1826.40.260	10
M40x1.5	24.0	32.0	50	47	14	EX1826.40.320	10
M50x1.5	28.0	36.0	55	48	14	EX1826.50.360	5
M50x1.5	35.0	42.0	60	50	14	EX1826.50.420	5
M63x1.5	36.0	44.0	65	51	14	EX1826.63.440	1
M63x1.5	43.0	50.0	70	51	14	EX1826.63.500	1

Auf Anfrage lieferbar:
 Anschlussgewinde Pg und NPT
 Rostfreier Stahl A2 oder A4

Available on request:
 Entry thread Pg and NPT
 Stainless steel A2 or A4

Anschlussgewinde NPT | Entry thread NPT

Material: Messing vernickelt
 Dichtung: NBR
 O-Ring: FPM
 Schutzart: IP 66 / IP 68 (30 bar)
 Prüfnorm: IEC EN 60079-0 / IEC EN 60079-1 / IEC EN 60079-7 / IEC EN 60079-31
 Gas: II 2G Ex db eb IIC
 Staub: II 2D Ex ta IIIC
 Zone: Gas 1 und 2 / Staub 21 und 22
 Zertifikat: PTB 10 ATEX 1034X
 IECEx Zertifikat: IECEx PTB 12.0055X
 Einsatztemperatur: -60 °C / +105 °C

Material: Nickel-plated brass
 Seal: NBR
 O-ring: FPM
 Protection class: IP 66 / IP 68 (30 bar)
 Test standard: IEC EN 60079-0 / IEC EN 60079-1 / IEC EN 60079-7 / IEC EN 60079-31
 Gas: II 2G Ex db eb IIC
 Dust: II 2D Ex ta IIIC
 Zone: Gas 1 and 2 / dust 21 and 22
 Certificate: PTB 10 ATEX 1034X
 IECEx Certificate: IECEx PTB 12.0055X
 Operation temperature: -60 °C / +105 °C

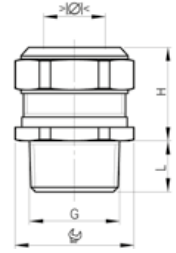

Einteiliger Dichteinsatz
 nicht durchgehend isolierend

One-piece sealing insert
 not overall length insulated

G	>math>\varnothing</math> min mm	>math>\varnothing</math> max mm	 mm	H mm	L mm	Art.-No.	
NPT 3/8"	3.0	7.0	21	26	15	EX1126.3/8NPT.070	25
NPT 3/8"	5.0	10.0	24	26	15	EX1126.3/8NPT.100	25
NPT 1/2"	5.0	11.0	24	26	15	EX1126.1/2NPT.110	25
NPT 1/2"	9.0	14.0	30	26	15	EX1126.1/2NPT.140	25
NPT 3/4"	7.5	15.0	32	28	15	EX1126.3/4NPT.150	20
NPT 3/4"	12.5	18.0	32	28	15	EX1126.3/4NPT.180	20
NPT 1"	17.0	23.0	41	33	20	EX1126.1NPT.230	10
NPT 1"	21.0	26.0	41	33	20	EX1126.1NPT.260	10
NPT 1 1/4"	24.0	32.0	50	34	20	EX1126.11/4NPT.320	10
NPT 1 1/2"	28.0	36.0	55	34	20	EX1126.11/2NPT.360	5
NPT 2"	36.0	44.0	65	35	22	EX1126.2NPT.440	5

Auf Anfrage lieferbar:
 Rostfreier Stahl A2 oder A4

Available on request:
 Stainless steel A2 or A4



EX Compact MS



Verschlusschrauben Messing druckfeste Kapselung Ex d IIC

Locking plugs nickel-plated brass flameproof enclosure Ex d IIC

Anschlussgewinde metrisch | Entry thread metric

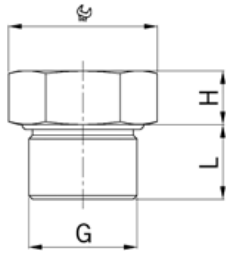

Material: Messing vernickelt
 O-Ring: FPM
 Schutzart: IP 68 (30 bar)
 Prüfnorm: IEC EN 60079-0 / IEC EN 60079-1 / IEC EN 60079-31
 Gas: II 2G Ex db eb IIC
 Staub: II 2D Ex ta IIC
 Zone: Gas 1 und 2 / Staub 21 und 22
 Zertifikat: PTB 00 ATEX 1059
 IECEx Zertifikat: IECEx PTB 12.0056
 Einsatztemperatur: -40 °C / +100 °C

Material: Nickel-plated brass
 O-ring: FPM
 Protection class: IP 68 (30 bar)
 Test standard: IEC EN 60079-0 / IEC EN 60079-1 / IEC EN 60079-31
 Gas: II 2G Ex db eb IIC
 Dust: II 2D Ex ta IIC
 Zone: Gas 1 and 2 / dust 21 and 22
 Certificate: PTB 00 ATEX 1059
 IECEx Certificate: IECEx PTB 12.0056
 Operation temperature: -40 °C / +100 °C



mit O-Ring

with O-ring

G	mm	H	L	mm	mm	Art.-No.	
M12x1.5	15	5	15			8710.12	10
M16x1.5	18	6	15			8710.17	10
M20x1.5	24	8	15			8710.20	10
M25x1.5	30	10	15			8710.25	10
M32x1.5	36	12	15			8710.32	10
M40x1.5	46	12	15			8710.40	10
M50x1.5	55	12	15			8710.50	10
M63x1.5	70	12	15			8710.63	10

Anschlussgewinde Pg | Entry thread Pg



mit O-Ring

with O-ring

G	mm	H	L	mm	mm	Art.-No.	
Pg 7	16	6.4	10.5			8710.07	10
Pg 9	18	7.5	12			8710.09	10
Pg 11	21	8.8	12			8710.11	10
Pg 13	24	10.0	14			8710.13	10
Pg 16	27	11.5	14			8710.16	10
Pg 21	32	14.0	16			8710.21	10
Pg 29	41	17.0	17			8710.29	10
Pg 36	55	22.5	17			8710.36	10

AGRO Kabelverschraubungen Progress® Messing erhöhte Sicherheit Ex e II

AGRO cable glands Progress® nickel-plated brass increased safety Ex e II

Kurzes Anschlussgewinde metrisch | Short entry thread metric

Material: Messing vernickelt
 Dichtung: TPE
 O-Ring: FPM
 Schutzart: IP 66 / IP 68 (bis 10 bar)
 Prüfnorm: IEC EN 60079-0 /
 IEC EN 60079-7 /
 IEC EN 60079-31
 Gas: II 2G Ex eb IIC Gb
 Staub: II 2D Ex tb IIIC Db
 Zone: Gas 1 und 2 /
 Staub 21 und 22
 Zertifikat: SEV 15 ATEX 0152X
 IECEx Zertifikat: IECEx SEV 15.0019X
 Einsatztemperatur: -60 °C / +100 °C

Material: Nickel-plated brass
 Seal: TPE
 O-ring: FPM
 Protection class: IP 66 / IP 68 (up to 10 bar)
 Test standard: IEC EN 60079-0 /
 IEC EN 60079-7 /
 IEC EN 60079-31
 Gas: II 2G Ex eb IIC Gb
 Dust: II 2D Ex tb IIIC Db
 Zone: Gas 1 and 2 /
 dust 21 and 22
 Certificate: SEV 15 ATEX 0152X
 IECEx Certificate: IECEx SEV 15.0019X
 Operation temperature: -60 °C / +100 °C

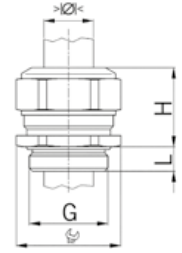

Einteiliger Dichteinsatz
 nicht durchgehend isolierend

One-piece sealing insert
 not overall length insulated

G	>Ø< min mm	>Ø< max mm	H mm	L mm	i info	Art.-No.	
M8x1.25	3.0	3.5	11	14	5 1	EX1000.08.035	50
M8x1.25	4.0	5.0	11	14	5 1	EX1000.08.050	50
M10x1.5	3.0	4.0	13	15	5 1	EX1000.10.040	50
M10x1.5	4.5	6.0	13	15	5 1	EX1000.10.060	50
M12x1.5	5.0	6.5	15	17	5 -	EX1000.12.065	50
M12x1.5	6.5	8.0	15	17	5 -	EX1000.12.080	50
M16x1.5	4.5	6.0	18	20	5 -	EX1000.17.060	50
M16x1.5	6.0	8.0	18	20	5 -	EX1000.17.080	50
M20x1.5	6.0	8.0	24	21	6 -	EX1000.20.080	50
M20x1.5	8.0	11.0	24	21	6 -	EX1000.20.110	50
M25x1.5	9.5	12.5	30	25	7 -	EX1000.25.125	25
M25x1.5	12.5	16.0	30	27	7 -	EX1000.25.160	25
M32x1.5	14.0	17.0	36	28	8 -	EX1000.32.170	25
M32x1.5	17.0	21.0	36	28	8 -	EX1000.32.210	25
M40x1.5	20.0	24.0	46	31	8 -	EX1000.40.240	10
M40x1.5	24.0	28.5	46	31	8 -	EX1000.40.285	10

1 = Metrisches Regelgewinde (mit VDE Testreport)
 Auf Anfrage lieferbar:
 Ausführungen in Stahl A2 und A4,
 Anschlussgewinde NPT

1 = Metric coarse-pitch thread (with VDE test report)
 Available on request:
 Executions in steel A2 and A4, entry thread NPT



Progress MS EX



1
2
3
4
5
6
7
8
9
10
11
12
13
14
15

AGRO Kabelverschraubungen Progress® Messing erhöhte Sicherheit Ex e II

AGRO cable glands Progress® nickel-plated brass increased safety Ex e II

Langes Anschlussgewinde metrisch | Long entry thread metric

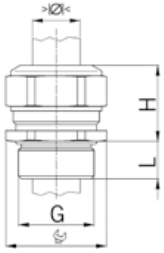

Material: Messing vernickelt
 Dichtung: TPE
 O-Ring: FPM
 Schutzart: IP 66 / IP 68 (bis 10 bar)
 Prüfnorm: IEC EN 60079-0 / IEC EN 60079-7 / IEC EN 60079-31
 Gas: II 2G Ex eb IIC Gb
 Staub: II 2D Ex tb IIIC Db
 Zone: Gas 1 und 2 / Staub 21 und 22
 Zertifikat: SEV 15 ATEX 0152X
 IECEx Zertifikat: IECEx SEV 15.0019X
 Einsatztemperatur: -60 °C / +100 °C

Material: Nickel-plated brass
 Seal: TPE
 O-ring: FPM
 Protection class: IP 66 / IP 68 (up to 10 bar)
 Test standard: IEC EN 60079-0 / IEC EN 60079-7 / IEC EN 60079-31
 Gas: II 2G Ex eb IIC Gb
 Dust: II 2D Ex tb IIIC Db
 Zone: Gas 1 and 2 / dust 21 and 22
 Certificate: SEV 15 ATEX 0152X
 IECEx Certificate: IECEx SEV 15.0019X
 Operation temperature: -60 °C / +100 °C



Progress MS EX



Einteiliger Dichteinsatz
 nicht durchgehend isolierend

One-piece sealing insert
 not overall length insulated

G	>Ø< min mm	>Ø< max mm	Ø mm	H mm	L mm	i info	Art.-No.	
M8x1.25	3.0	3.5	11	14	10	1	EX1100.08.035	50
M8x1.25	4.0	5.0	11	14	10	1	EX1100.08.050	50
M10x1.5	3.0	4.0	13	15	10	1	EX1100.10.040	50
M10x1.5	4.5	6.0	13	15	10	1	EX1100.10.060	50
M12x1.5	5.0	6.5	15	17	10	-	EX1100.12.065	50
M12x1.5	6.5	8.0	15	17	10	-	EX1100.12.080	50
M16x1.5	4.5	6.0	18	20	10	-	EX1100.17.060	50
M16x1.5	6.0	8.0	18	20	10	-	EX1100.17.080	50
M20x1.5	6.0	8.0	24	21	10	-	EX1100.20.080	50
M20x1.5	8.0	11.0	24	21	10	-	EX1100.20.110	50
M25x1.5	9.5	12.5	30	25	11	-	EX1100.25.125	25
M25x1.5	12.5	16.0	30	27	11	-	EX1100.25.160	25
M32x1.5	14.0	17.0	36	28	13	-	EX1100.32.170	25
M32x1.5	17.0	21.0	36	28	13	-	EX1100.32.210	25
M40x1.5	20.0	24.0	46	31	13	-	EX1100.40.240	10
M40x1.5	24.0	28.5	46	31	13	-	EX1100.40.285	10

1 = Metrisches Regelgewinde (mit VDE Testreport)

1 = Metric coarse-pitch thread (with VDE test report)

Auf Anfrage lieferbar:

Available on request:

Ausführungen in Stahl A2 und A4,
 Anschlussgewinde NPT

Executions in steel A2 and A4, entry thread NPT

AGRO Kabelverschraubungen Progress® Messing erhöhte Sicherheit Ex e II

AGRO cable glands Progress® nickel-plated brass increased safety Ex e II

Kurzes Anschlussgewinde Pg | Short entry thread Pg

Material: Messing vernickelt
 Dichtung: TPE
 O-Ring: FPM
 Schutzart: IP 66 / IP 68 (bis 10 bar)
 Prüfnorm: IEC EN 60079-0 /
 IEC EN 60079-7 /
 IEC EN 60079-31
 Gas: II 2G Ex eb IIC Gb
 Staub: II 2D Ex tb IIIC Db
 Zone: Gas 1 und 2 /
 Staub 21 und 22
 Zertifikat: SEV 15 ATEX 0152X
 IECEx Zertifikat: IECEx SEV 15.0019X
 Einsatztemperatur: -60 °C / +100 °C

Material: Nickel-plated brass
 Seal: TPE
 O-ring: FPM
 Protection class: IP 66 / IP 68 (up to 10 bar)
 Test standard: IEC EN 60079-0 /
 IEC EN 60079-7 /
 IEC EN 60079-31
 Gas: II 2G Ex eb IIC Gb
 Dust: II 2D Ex tb IIIC Db
 Zone: Gas 1 and 2 /
 dust 21 and 22
 Certificate: SEV 15 ATEX 0152X
 IECEx Certificate: IECEx SEV 15.0019X
 Operation temperature: -60 °C / +100 °C

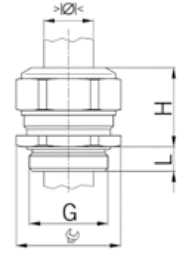

Einteiliger Dichteinsatz
 nicht durchgehend isolierend

One-piece sealing insert
 not overall length insulated

G	$\begin{matrix} > \varnothing < \\ \text{min mm} \end{matrix}$	$\begin{matrix} > \varnothing < \\ \text{max mm} \end{matrix}$	$\begin{matrix} \varnothing \\ \text{mm} \end{matrix}$	H	L	Art.-No.	
	min mm	max mm	mm	mm	mm		
Pg 7	5.0	6.5	15	17	6	EX1000.07.065	50
Pg 7	6.5	8.0	15	17	6	EX1000.07.080	50
Pg 9	4.5	6.0	18	20	6	EX1000.09.060	50
Pg 9	6.0	8.0	18	20	6	EX1000.09.080	50
Pg 11	4.0	5.5	21	21	6	EX1000.11.055	50
Pg 11	5.5	8.5	21	21	6	EX1000.11.085	50
Pg 13	6.0	8.0	24	21	6	EX1000.13.080	50
Pg 13	8.0	11.0	24	21	6	EX1000.13.110	50
Pg 16	6.0	8.0	24	21	6	EX1000.16.080	50
Pg 16	8.0	11.0	24	21	6	EX1000.16.110	50
Pg 21	9.5	12.5	30	25	7.5	EX1000.21.125	25
Pg 21	12.5	16.0	30	25	7.5	EX1000.21.160	25
Pg 29	16.0	19.0	38	28	8	EX1000.29.190	25
Pg 29	19.0	23.0	38	28	8	EX1000.29.230	25
Pg 36	21.5	26.0	50	32	8	EX1000.36.260	10
Pg 36	26.0	30.5	50	32	8	EX1000.36.305	10

Auf Anfrage lieferbar:
 Ausführungen in Stahl A2 und A4,
 Anschlussgewinde NPT

Available on request:
 Executions in steel A2 and A4, entry thread NPT



Progress MS EX



AGRO Kabelverschraubungen Progress® Messing erhöhte Sicherheit Ex e II

AGRO cable glands Progress® nickel-plated brass increased safety Ex e II

Langes Anschlussgewinde Pg | Long entry thread Pg

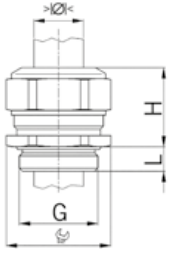

Material: Messing vernickelt
 Dichtung: TPE
 O-Ring: FPM
 Schutzart: IP 66 / IP 68 (bis 10 bar)
 Prüfnorm: IEC EN 60079-0 / IEC EN 60079-7 / IEC EN 60079-31
 Gas: II 2G Ex eb IIC Gb
 Staub: II 2D Ex tb IIIC Db
 Zone: Gas 1 und 2 / Staub 21 und 22
 Zertifikat: SEV 15 ATEX 0152X
 IECEx Zertifikat: IECEx SEV 15.0019X
 Einsatztemperatur: -60 °C / +100 °C

Material: Nickel-plated brass
 Seal: TPE
 O-ring: FPM
 Protection class: IP 66 / IP 68 (up to 10 bar)
 Test standard: IEC EN 60079-0 / IEC EN 60079-7 / IEC EN 60079-31
 Gas: II 2G Ex eb IIC Gb
 Dust: II 2D Ex tb IIIC Db
 Zone: Gas 1 and 2 / dust 21 and 22
 Certificate: SEV 15 ATEX 0152X
 IECEx Certificate: IECEx SEV 15.0019X
 Operation temperature: -60 °C / +100 °C



Progress MS EX



Einteiliger Dichteinsatz
 nicht durchgehend isolierend

One-piece sealing insert
 not overall length insulated

G	>D< min mm	>D< max mm	 mm	H mm	L mm	Art.-No.	
Pg 7	5.0	6.5	15	17	10	EX1100.07.065	50
Pg 7	6.5	8.0	15	17	10	EX1100.07.080	50
Pg 9	4.5	6.0	18	20	10	EX1100.09.060	50
Pg 9	6.0	8.0	18	20	10	EX1100.09.080	50
Pg 11	4.0	5.5	21	21	10	EX1100.11.055	50
Pg 11	5.5	8.5	21	21	10	EX1100.11.085	50
Pg 13	6.0	8.0	24	21	10	EX1100.13.080	50
Pg 13	8.0	11.0	24	21	10	EX1100.13.110	50
Pg 16	6.0	8.0	24	21	10	EX1100.16.080	50
Pg 16	8.0	11.0	24	21	10	EX1100.16.110	50
Pg 21	9.5	12.5	30	25	12	EX1100.21.125	25
Pg 21	12.5	16.0	30	25	12	EX1100.21.160	25
Pg 29	16.0	19.0	38	28	12	EX1100.29.190	25
Pg 29	19.0	23.0	38	28	12	EX1100.29.230	25
Pg 36	21.5	26.0	50	32	15	EX1100.36.260	10
Pg 36	26.0	30.5	50	32	15	EX1100.36.305	10

Auf Anfrage lieferbar:
 Ausführungen in Stahl A2 und A4,
 Anschlussgewinde NPT

Available on request:
 Executions in steel A2 and A4, entry thread NPT

Kurzes Anschlussgewinde metrisch | Short entry thread metric

Material: Messing vernickelt
 Dichtung: TPE / NBR
 O-Ring: FPM
 Schutzart: IP 66 / IP 68
 Prüfnorm: IEC EN 60079-0 /
 IEC EN 60079-7 /
 IEC EN 60079-31
 Gas: II 2G Ex eb IIC Gb
 Staub: II 2D Ex tb IIIC Db
 Zone: Gas 1 und 2 /
 Staub 21 und 22
 Zertifikat: SEV 15 ATEX 0152X
 IECEx Zertifikat: IECEx SEV 15.0019X
 Einsatztemperatur: -60 °C / +100 °C

Material: Nickel-plated brass
 Seal: TPE / NBR
 O-ring: FPM
 Protection class: IP 66 / IP 68
 Test standard: IEC EN 60079-0 /
 IEC EN 60079-7 /
 IEC EN 60079-31
 Gas: II 2G Ex eb IIC Gb
 Dust: II 2D Ex tb IIIC Db
 Zone: Gas 1 and 2 /
 dust 21 and 22
 Certificate: SEV 15 ATEX 0152X
 IECEx Certificate: IECEx SEV 15.0019X
 Operation temperature: -60 °C / +100 °C

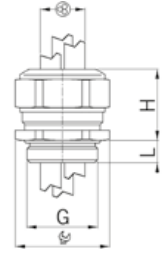

Einteiliger Dichteinsatz
 nicht durchgehend isolierend

One-piece sealing insert
 not overall length insulated

G	>Ø< min mm	>Ø< max mm	⊗ mm	⊗ mm	H mm	L mm	i info	Art.-No.	
M12x1.5	0.6	1.0	3	15	17	5	3	EX1310.12.3.010	50
M16x1.5	1.0	1.5	4	18	20	5	3	EX1310.17.4.015	50
M16x1.5	2.0	3.0	2	18	20	5	-	EX1310.17.2.030	50
M20x1.5	2.5	3.0	6	24	21	6	-	EX1310.20.6.030	50
M20x1.5	3.5	5.0	2	24	21	6	-	EX1310.20.2.050	50
M20x1.5	3.5	5.0	4	24	21	6	-	EX1310.20.4.050	50
M20x1.5	4.5	6.0	3	24	21	6	-	EX1310.20.3.060	50
M20x1.5	5.5	7.5	2	24	21	6	-	EX1310.20.2.075	50
M25x1.5	5.0	6.0	6	30	25	7	-	EX1310.25.6.060	25
M25x1.5	6.0	7.0	3	30	25	7	-	EX1310.25.3.070	25
M25x1.5	5.5	7.0	4	30	25	7	-	EX1310.25.4.070	25
M25x1.5	7.5	9.0	3	30	25	7	-	EX1310.25.3.090	25
M25x1.5	8.0	10.0	2	30	25	7	-	EX1310.25.2.100	25
M32x1.5	6.0	7.0	6	36	28	8	-	EX1310.32.6.070	25
M32x1.5	7.5	9.0	4	36	28	8	-	EX1310.32.4.090	25
M40x1.5	8.0	9.0	7	46	31	8	3	EX1310.40.7.090	10
M40x1.5	14.0	15.0	2	46	31	8	3	EX1310.40.2.150	10
M50x1.5	9.0	10.0	4	55	34	9	3	EX1310.50.4.100	10
M63x1.5	11.0	12.0	6	70	37	10	3	EX1310.63.6.120	5
M63x1.5	17.0	18.0	3	70	37	10	3	EX1310.63.3.180	5

3 = Material Dichteinsatz NBR
 Passende Verschlussbolzen siehe Zubehör
 Auf Anfrage lieferbar:
 Ausführungen in Stahl A2 und A4,
 Anschlussgewinde NPT

3 = Material sealing insert NBR
 Suitable locking pins see accessories
 Available on request:
 Executions in steel A2 and A4, entry thread NPT



Progress MS Multi EX



Kurzes Anschlussgewinde Pg | Short entry thread Pg

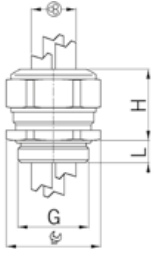

Material: Messing vernickelt
 Dichtung: TPE / NBR
 O-Ring: FPM
 Schutzart: IP 66 / IP 68
 Prüfnorm: IEC EN 60079-0 / IEC EN 60079-7 / IEC EN 60079-31
 Gas: II 2G Ex eb IIC Gb
 Staub: II 2D Ex tb IIIC Db
 Zone: Gas 1 und 2 / Staub 21 und 22
 Zertifikat: SEV 15 ATEX 0152X
 IECEx Zertifikat: IECEx SEV 15.0019X
 Einsatztemperatur: -60 °C / +100 °C

Material: Nickel-plated brass
 Seal: TPE / NBR
 O-ring: FPM
 Protection class: IP 66 / IP 68
 Test standard: IEC EN 60079-0 / IEC EN 60079-7 / IEC EN 60079-31
 Gas: II 2G Ex eb IIC Gb
 Dust: II 2D Ex tb IIIC Db
 Zone: Gas 1 and 2 / dust 21 and 22
 Certificate: SEV 15 ATEX 0152X
 IECEx Certificate: IECEx SEV 15.0019X
 Operation temperature: -60 °C / +100 °C



Progress MS Multi EX



Einteiliger Dichteinsatz
 nicht durchgehend isolierend

One-piece sealing insert
 not overall length insulated

G	>Ø< min mm	>Ø< max mm	⊗ mm	H mm	L mm	i info	Art.-No.	
Pg 9	1.0	1.5	4	18	20	6 3	EX1310.09.4.015	50
Pg 9	2.0	3.0	2	18	20	6 -	EX1310.09.2.030	50
Pg 11	2.0	3.0	3	21	21	6 3	EX1310.11.3.030	50
Pg 11	3.0	4.0	2	21	21	6 3	EX1310.11.2.040	50
Pg 11	3.5	5.0	2	21	21	6 -	EX1310.11.2.050	50
Pg 13	2.5	4.0	3	24	23	6 3	EX1310.13.3.040	50
Pg 13	3.5	5.0	2	24	23	6 -	EX1310.13.2.050	50
Pg 16	2.5	3.0	6	24	23	6 -	EX1310.16.6.030	50
Pg 16	3.0	4.0	6	24	23	6 3	EX1310.16.6.040	50
Pg 16	4.5	6.0	2	24	23	6 -	EX1310.16.2.060	50
Pg 16	4.5	6.0	3	24	23	6 -	EX1310.16.3.060	50
Pg 21	5.5	7.0	4	30	28	7 -	EX1310.21.4.070	25
Pg 21	7.5	9.0	3	30	28	7 -	EX1310.21.3.090	25
Pg 29	5.5	6.5	6	38	28	8 3	EX1310.29.6.065	25
Pg 29	8.0	9.0	3	38	28	8 -	EX1310.29.3.090	25
Pg 36	9.0	10.0	4	50	32	8 3	EX1310.36.4.100	10
Pg 36	14.0	15.0	2	50	32	8 3	EX1310.36.2.150	10
Pg 48	11.0	12.0	6	65	37	11 3	EX1310.48.6.120	10
Pg 48	17.0	18.0	3	65	37	11 3	EX1310.48.3.180	10

3 = Material Dichteinsatz NBR

3 = Material sealing insert NBR

Passende Verschlussbolzen siehe Zubehör

Suitable locking pins see accessories

Auf Anfrage lieferbar:

Available on request:

Ausführungen in Stahl A2 und A4,
 Anschlussgewinde NPT

Executions in steel A2 and A4, entry thread NPT

Kurzes Anschlussgewinde metrisch | Short entry thread metric

Material: Messing vernickelt
 Schrauben: Rostfreier Stahl A2
 Dichtung: TPE
 O-Ring: FPM
 Schutzart: IP 66 / IP 68 (bis 10 bar)
 Prüfnorm: IEC EN 60079-0 / IEC EN 60079-7 / IEC EN 60079-31
 Gas: II 2G Ex eb IIC Gb
 Staub: II 2D Ex tb IIIC Db
 Zone: Gas 1 und 2 / Staub 21 und 22
 Zertifikat: SEV 15 ATEX 0151
 IECEx Zertifikat: IECEx SEV 15.0018
 Einsatztemperatur: -60 °C / +100 °C

Material: Nickel-plated brass
 Screws: Stainless steel A2
 Seal: TPE
 O-ring: FPM
 Protection class: IP 66 / IP 68 (up to 10 bar)
 Test standard: IEC EN 60079-0 / IEC EN 60079-7 / IEC EN 60079-31
 Gas: II 2G Ex eb IIC Gb
 Dust: II 2D Ex tb IIIC Db
 Zone: Gas 1 and 2 / dust 21 and 22
 Certificate: SEV 15 ATEX 0151
 IECEx Certificate: IECEx SEV 15.0018
 Operation temperature: -60 °C / +100 °C

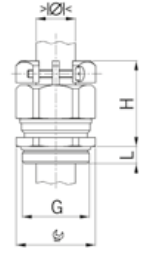

Zweiteiliger Dichteinsatz nicht durchgehend isolierend		Two-piece sealing insert not overall length insulated								
G	> Ø <	> Ø <	> Ø <	> Ø <	H	L	i	Art.-No.		
	min mm	max mm	min mm	max mm	mm	mm	info			
M12x1.5	-	-	5.0	6.5	15/16	26	5	1/2	EX1803.12.03.065	50
M12x1.5	-	-	6.5	8.0	15/16	26	5	1/2	EX1803.12.03.080	50
M16x1.5	6.0	8.0	8.0	10.5	18/19	30	5	-	EX1803.17	50
M20x1.5	8.0	11.0	11.0	15.0	24	31	6	-	EX1803.20	50
M25x1.5	12.5	16.0	16.0	20.5	30	35	7	-	EX1803.25	25
M32x1.5	17.0	21.0	21.0	25.5	36	40	8	-	EX1803.32	25
M40x1.5	24.0	28.5	28.5	33.0	46	44	8	-	EX1803.40	10
M50x1.5	33.0	37.0	37.0	42.0	55	49	9	-	EX1803.50	10
M63x1.5	40.0	46.0	46.0	52.0	70	55	10	-	EX1803.63	5

1 = Einteiliger Dichteinsatz	1 = One-piece sealing insert
2 = Zertifikat SEV 15 ATEX 0152X / IECEx SEV 15.0019X	2 = Certificate SEV 15 ATEX 0152X / IECEx SEV 15.0019X
Auf Anfrage lieferbar:	Available on request:
Langes Anschlussgewinde	Long entry thread
Ausführungen in Stahl A2 und A4	Executions in steel A2 and A4



Progress MS KB EX



Kurzes Anschlussgewinde Pg | Short entry thread Pg

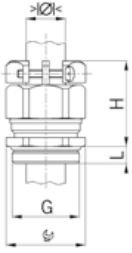

Material:	Messing vernickelt	Material:	Nickel-plated brass
Schrauben:	Rostfreier Stahl A2	Screws:	Stainless steel A2
Dichtung:	TPE	Seal:	TPE
O-Ring:	FPM	O-ring:	FPM
Schutzart:	IP 66 / IP 68 (bis 10 bar)	Protection class:	IP 66 / IP 68 (up to 10 bar)
Prüfnorm:	IEC EN 60079-0 / IEC EN 60079-7 / IEC EN 60079-31	Test standard:	IEC EN 60079-0 / IEC EN 60079-7 / IEC EN 60079-31
Gas:	II 2G Ex eb IIC Gb	Gas:	II 2G Ex eb IIC Gb
Staub:	II 2D Ex tb IIIC Db	Dust:	II 2D Ex tb IIIC Db
Zone:	Gas 1 und 2 / Staub 21 und 22	Zone:	Gas 1 and 2 / dust 21 and 22
Zertifikat:	SEV 15 ATEX 0151	Certificate:	SEV 15 ATEX 0151
IECEx Zertifikat:	IECEx SEV 15.0018	IECEx Certificate:	IECEx SEV 15.0018
Einsatztemperatur:	-60 °C / +100 °C	Operation temperature:	-60 °C / +100 °C



Progress MS KB EX



Zweiteiliger Dichteinsatz
nicht durchgehend isolierend

Two-piece sealing insert
not overall length insulated

G	> Ø <	> Ø <	> Ø <	> Ø <	mm	H	L	i	Art.-No.	
	min mm	max mm	min mm	max mm		mm	mm	info		
Pg 7	-	-	5.0	6.5	15/16	26	6	1/2	EX1803.07.03.065	50
Pg 7	-	-	6.5	8.0	15/16	26	6	1/2	EX1803.07.03.080	50
Pg 9	6.0	8.0	8.0	10.5	18/19	30	6	-	EX1803.09	50
Pg 11	5.5	8.5	8.5	12.0	21	31	6	-	EX1803.11	50
Pg 13	8.0	11.0	11.0	15.0	24	31	6	-	EX1803.13	50
Pg 16	8.0	11.0	11.0	15.0	24	31	6	-	EX1803.16	50
Pg 21	12.5	16.0	16.0	20.5	30	35	7.5	-	EX1803.21	25
Pg 29	19.0	23.0	23.0	27.5	38	40	8	-	EX1803.29	25
Pg 36	26.0	30.5	30.5	35.0	50	47	8	-	EX1803.36	10
Pg 42	33.0	37.0	37.0	42.0	55	49	10	-	EX1803.42	10
Pg 48	37.0	43.0	43.0	49.0	65	51	11	-	EX1803.48	5

1 = Einteiliger Dichteinsatz

1 = One-piece sealing insert

2 = Zertifikat SEV 15 ATEX 0152X / IECEx SEV 15.0019X

2 = Certificate SEV 15 ATEX 0152X / IECEx SEV 15.0019X

Auf Anfrage lieferbar:

Available on request:

Langes Anschlussgewinde

Long entry thread

Ausführungen in Stahl A2 und A4

Executions in steel A2 and A4

Kurzes Anschlussgewinde metrisch | Short entry thread metric

Material: Messing vernickelt
 Schrauben: Rostfreier Stahl A2
 Dichtung: TPE
 O-Ring: FPM
 Schutzart: IP 66 / IP 68 (bis 10 bar)
 Prüfnorm: IEC EN 60079-0 / IEC EN 60079-7 / IEC EN 60079-31
 Gas: II 2G Ex eb IIC Gb
 Staub: II 2D Ex tb IIIC Db
 Zone: Gas 1 und 2 / Staub 21 und 22
 Zertifikat: SEV 15 ATEX 0151
 IECEx Zertifikat: IECEx SEV 15.0018
 Einsatztemperatur: -60 °C / +100 °C

Material: Nickel-plated brass
 Screws: Stainless steel A2
 Seal: TPE
 O-ring: FPM
 Protection class: IP 66 / IP 68 (up to 10 bar)
 Test standard: IEC EN 60079-0 / IEC EN 60079-7 / IEC EN 60079-31
 Gas: II 2G Ex eb IIC Gb
 Dust: II 2D Ex tb IIIC Db
 Zone: Gas 1 and 2 / dust 21 and 22
 Certificate: SEV 15 ATEX 0151
 IECEx Certificate: IECEx SEV 15.0018
 Operation temperature: -60 °C / +100 °C

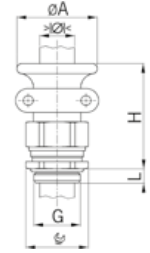

Zweiteiliger Dichteinsatz nicht durchgehend isolierend		Two-piece sealing insert not overall length insulated									
G	> Ø <	> Ø <	> Ø <	> Ø <	ØA	H	L	Art.-No.			
	min mm	max mm	min mm	max mm	mm	mm	mm				
M16x1.5	6.0	8.0	8.0	10.5	18	28	43	EX1801.17	50		
M20x1.5	8.0	11.0	11.0	15.0	24	34	46	EX1801.20	50		
M25x1.5	12.5	16.0	16.0	20.5	30	44	52	EX1801.25	25		
M32x1.5	17.0	21.0	21.0	25.5	36	50	59	EX1801.32	10		
M40x1.5	24.0	28.5	28.5	33.0	46	57	59	EX1801.40	5		



Progress MS T+KB EX



Langes Anschlussgewinde metrisch | Long entry thread metric

Zweiteiliger Dichteinsatz nicht durchgehend isolierend		Two-piece sealing insert not overall length insulated									
G	> Ø <	> Ø <	> Ø <	> Ø <	ØA	H	L	Art.-No.			
	min mm	max mm	min mm	max mm	mm	mm	mm				
M16x1.5	6.0	8.0	8.0	10.5	18	28	43	EX1811.17	50		
M20x1.5	8.0	11.0	11.0	15.0	24	34	46	EX1811.20	50		
M25x1.5	12.5	16.0	16.0	20.5	30	44	52	EX1811.25	25		
M32x1.5	17.0	21.5	21.5	25.5	36	50	59	EX1811.32	10		
M40x1.5	24.0	28.5	28.5	33.0	46	57	59	EX1811.40	5		



Progress MS T+KB EX



Kurzes Anschlussgewinde Pg | Short entry thread Pg

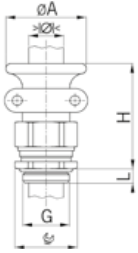

Material:	Messing vernickelt	Material:	Nickel-plated brass
Schrauben:	Rostfreier Stahl A2	Screws:	Stainless steel A2
Dichtung:	TPE	Seal:	TPE
O-Ring:	FPM	O-ring:	FPM
Schutzart:	IP 66 / IP 68 (bis 10 bar)	Protection class:	IP 66 / IP 68 (up to 10 bar)
Prüfnorm:	IEC EN 60079-0 / IEC EN 60079-7 / IEC EN 60079-31	Test standard:	IEC EN 60079-0 / IEC EN 60079-7 / IEC EN 60079-31
Gas:	II 2G Ex eb IIC Gb	Gas:	II 2G Ex eb IIC Gb
Staub:	II 2D Ex tb IIIC Db	Dust:	II 2D Ex tb IIIC Db
Zone:	Gas 1 und 2 / Staub 21 und 22	Zone:	Gas 1 and 2 / dust 21 and 22
Zertifikat:	SEV 15 ATEX 0151	Certificate:	SEV 15 ATEX 0151
IECEX Zertifikat:	IECEX SEV 15.0018	IECEX Certificate:	IECEX SEV 15.0018
Einsatztemperatur:	-60 °C / +100 °C	Operation temperature:	-60 °C / +100 °C



Progress MS T+KB EX



Zweiteiliger Dichteinsatz
nicht durchgehend isolierend

Two-piece sealing insert
not overall length insulated

G	>ØK min mm	>ØK max mm	>ØK min mm	>ØK max mm	Ø mm	ØA mm	H mm	L mm	Art.-No.	
Pg 9	6.0	8.0	8.0	10.5	18	28	43	6	EX1801.09	50
Pg 11	5.5	8.5	8.5	12.0	21	30	43	6	EX1801.11	50
Pg 13	8.0	11.0	11.0	15.0	24	34	46	6	EX1801.13	50
Pg 16	8.0	11.0	11.0	15.0	24	34	46	6	EX1801.16	50
Pg 21	12.5	16.0	16.0	20.5	30	44	52	7.5	EX1801.21	25
Pg 29	19.0	23.0	23.0	27.5	38	50	59	8	EX1801.29	10

Langes Anschlussgewinde Pg | Long entry thread Pg



Progress MS T+KB EX



Zweiteiliger Dichteinsatz
nicht durchgehend isolierend

Two-piece sealing insert
not overall length insulated

G	>ØK min mm	>ØK max mm	>ØK min mm	>ØK max mm	Ø mm	ØA mm	H mm	L mm	Art.-No.	
Pg 9	6.0	8.0	8.0	10.5	18	28	43	10	EX1811.09	50
Pg 11	5.5	8.5	8.5	12.0	21	30	43	10	EX1811.11	50
Pg 13	8.0	11.0	11.0	15.0	24	34	46	10	EX1811.13	50
Pg 16	8.0	11.0	11.0	15.0	24	34	46	10	EX1811.16	50
Pg 21	12.5	16.0	16.0	20.5	30	44	52	12	EX1811.21	25
Pg 29	19.0	23.0	23.0	27.5	38	50	59	12	EX1811.29	10

Kurzes Anschlussgewinde metrisch | Short entry thread metric

Material:	Messing vernickelt	Material:	Nickel-plated brass
Dichtung:	TPE	Seal:	TPE
O-Ring:	FPM	O-ring:	FPM
Schutzart:	IP 66 / IP 68 (bis 10 bar)	Protection class:	IP 66 / IP 68 (up to 10 bar)
Prüfnorm:	IEC EN 60079-0 / IEC EN 60079-7 / IEC EN 60079-31	Test standard:	IEC EN 60079-0 / IEC EN 60079-7 / IEC EN 60079-31
Gas:	II 2G Ex eb IIC Gb	Gas:	II 2G Ex eb IIC Gb
Staub:	II 2D Ex tb IIIC Db	Dust:	II 2D Ex tb IIIC Db
Zone:	Gas 1 und 2 / Staub 21 und 22	Zone:	Gas 1 and 2 / dust 21 and 22
Zertifikat:	SEV 15 ATEX 0152X	Certificate:	SEV 15 ATEX 0152X
IECEX Zertifikat:	IECEX SEV 15.0019X	IECEX Certificate:	IECEX SEV 15.0019X
Eigenschaften:	Für zeitsparende Montage von partiell abisolierten so- wie durchgehend geschirm- ten Kabeln	Properties:	For a quick installation of partially dismantled cables as well as thoroughly shielded cables
Einsatztemperatur:	-60 °C / +100 °C	Operation temperature:	-60 °C / +100 °C

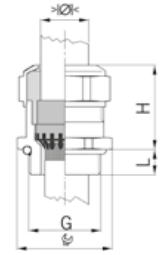

Einteiliger Dichteinsatz
nicht durchgehend isolierend

One-piece sealing insert
not overall length insulated

G	$\begin{matrix} > O < \\ \text{min mm} \end{matrix}$	$\begin{matrix} > O < \\ \text{max mm} \end{matrix}$	$\begin{matrix} \text{mm} \\ \text{mm} \end{matrix}$	H	L	Art.-No.	
M12x1.5	4.5	6.0	15	20	5	EX1081.12.060	50
M12x1.5	6.0	7.5	15	20	5	EX1081.12.075	50
M16x1.5	6.0	8.0	18	23	5	EX1081.17.080	50
M16x1.5	8.0	10.0	18	25	5	EX1081.17.100	50
M20x1.5	8.0	11.0	24	25	6	EX1081.20.110	50
M20x1.5	11.0	14.0	24	27	6	EX1081.20.140	50
M25x1.5	13.0	16.0	30	30	7	EX1081.25.160	25
M25x1.5	17.0	19.0	30	33	7	EX1081.25.190	25
M32x1.5	18.0	21.0	36	32	8	EX1081.32.210	25

Langes Anschlussgewinde auf Anfrage

Long entry thread available on request



Progress MS EMC
Rapid EX



Kurzes Anschlussgewinde Pg | Short entry thread Pg

Einteiliger Dichteinsatz
nicht durchgehend isolierend

One-piece sealing insert
not overall length insulated

G	$\begin{matrix} > O < \\ \text{min mm} \end{matrix}$	$\begin{matrix} > O < \\ \text{max mm} \end{matrix}$	$\begin{matrix} \text{mm} \\ \text{mm} \end{matrix}$	H	L	Art.-No.	
Pg 7	4.5	6.0	15	20	6	EX1081.07.060	50
Pg 7	6.0	7.5	15	20	6	EX1081.07.075	50
Pg 9	6.0	8.0	18	23	6	EX1081.09.080	50
Pg 9	8.0	10.0	18	25	6	EX1081.09.100	50
Pg 11	5.5	8.5	21	25	6	EX1081.11.085	50
Pg 11	8.5	12.0	21	25	6	EX1081.11.120	50
Pg 13	8.0	11.0	24	25	6	EX1081.13.110	50
Pg 13	12.5	14.0	24	27	6	EX1081.13.140	50
Pg 16	8.0	11.0	24	24	6	EX1081.16.110	50
Pg 16	12.5	14.0	24	27	6	EX1081.16.140	50
Pg 21	13.0	16.0	30	30	7	EX1081.21.160	25
Pg 21	17.0	19.0	30	33	7	EX1081.21.190	25
Pg 29	19.0	23.0	38	33	8	EX1081.29.230	25
Pg 29	23.0	25.5	38	32	8	EX1081.29.255	25

Langes Anschlussgewinde auf Anfrage

Long entry thread available on request



Progress MS EMC
Rapid EX



Kurzes Anschlussgewinde metrisch | Short entry thread metric

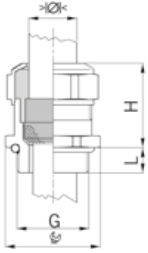

Material: Messing vernickelt
 Dichtung: TPE
 O-Ring: FPM
 Schutzart: IP 66 / IP 68 (bis 10 bar)
 Prüfnorm: IEC EN 60079-0 / IEC EN 60079-7 / IEC EN 60079-31
 Gas: II 2G Ex eb IIC Gb
 Staub: II 2D Ex tb IIIC Db
 Zone: Gas 1 und 2 / Staub 21 und 22
 Zertifikat: SEV 15 ATEX 0152X
 IECEx Zertifikat: IECEx SEV 15.0019X
 Eigenschaften: Sehr guter Schirmkontakt über die Kontakthülse bei in der Kabelverschraubung endendem Schirmgeflecht
 Einsatztemperatur: -60 °C / +100 °C

Material: Nickel-plated brass
 Seal: TPE
 O-ring: FPM
 Protection class: IP 66 / IP 68 (up to 10 bar)
 Test standard: IEC EN 60079-0 / IEC EN 60079-7 / IEC EN 60079-31
 Gas: II 2G Ex eb IIC Gb
 Dust: II 2D Ex tb IIIC Db
 Zone: Gas 1 and 2 / dust 21 and 22
 Certificate: SEV 15 ATEX 0152X
 IECEx Certificate: IECEx SEV 15.0019X
 Properties: Excellent shield contact through the contact sleeve with the braided shield terminating in the screwed cable gland
 Operation temperature: -60 °C / +100 °C



Progress MS EMC EX



Einteiliger Dichteinsatz
 nicht durchgehend isolierend

One-piece sealing insert
 not overall length insulated

G	>Ø< min mm	>Ø< max mm	Ø mm	H mm	L mm	i info	Art.-No.	
M8x1.25	2.5	3.5	11	15	5	1	EX1080.08.035	50
M8x1.25	3.0	4.0	11	15	5	1	EX1080.08.040	50
M10x1.5	3.0	4.0	13	16	5	1	EX1080.10.040	50
M10x1.5	4.0	6.0	13	16	5	1	EX1080.10.060	50
M12x1.5	4.5	6.0	15	20	5	-	EX1080.12.060	50
M12x1.5	6.0	7.5	15	20	5	-	EX1080.12.075	50
M16x1.5	6.0	8.0	18	23	5	-	EX1080.17.080	50
M16x1.5	8.0	10.0	18	25	5	-	EX1080.17.100	50
M20x1.5	8.0	11.0	24	25	6	-	EX1080.20.110	50
M20x1.5	12.5	14.0	24	27	6	-	EX1080.20.140	50
M25x1.5	13.0	16.0	30	30	7	-	EX1080.25.160	25
M25x1.5	17.0	19.0	30	33	7	-	EX1080.25.190	25
M32x1.5	17.0	21.0	36	32	8	-	EX1080.32.210	25
M40x1.5	24.0	28.5	46	34	8	-	EX1080.40.285	10

1 = Metrisches Regelgewinde (mit VDE Testreport)

1 = Metric coarse-pitch thread (with VDE test report)

Langes Anschlussgewinde auf Anfrage

Long entry thread available on request

Kurzes Anschlussgewinde Pg | Short entry thread Pg

Material: Messing vernickelt
 Dichtung: TPE
 O-Ring: FPM
 Schutzart: IP 66 / IP 68 (bis 10 bar)
 Prüfnorm: IEC EN 60079-0 / IEC EN 60079-7 / IEC EN 60079-31
 Gas: II 2G Ex eb IIC Gb
 Staub: II 2D Ex tb IIIC Db
 Zone: Gas 1 und 2 / Staub 21 und 22
 Zertifikat: SEV 15 ATEX 0152X
 IECEx Zertifikat: IECEx SEV 15.0019X
 Eigenschaften: Sehr guter Schirmkontakt über die Kontakthülse bei in der Kabelverschraubung endendem Schirmgeflecht
 Einsatztemperatur: -60 °C / +100 °C

Material: Nickel-plated brass
 Seal: TPE
 O-ring: FPM
 Protection class: IP 66 / IP 68 (up to 10 bar)
 Test standard: IEC EN 60079-0 / IEC EN 60079-7 / IEC EN 60079-31
 Gas: II 2G Ex eb IIC Gb
 Dust: II 2D Ex tb IIIC Db
 Zone: Gas 1 and 2 / dust 21 and 22
 Certificate: SEV 15 ATEX 0152X
 IECEx Certificate: IECEx SEV 15.0019X
 Properties: Excellent shield contact through the contact sleeve with the braided shield terminating in the screwed cable gland
 Operation temperature: -60 °C / +100 °C

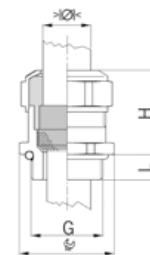

Einteiliger Dichteinsatz nicht durchgehend isolierend						One-piece sealing insert not overall length insulated	
G	> Ø <	> Ø <	⌀	H	L	Art.-No.	
	min mm	max mm	mm	mm	mm		
Pg 7	4.5	6.0	15	20	6	EX1080.07.060	50
Pg 7	6.0	7.5	15	20	6	EX1080.07.075	50
Pg 9	6.0	8.0	18	23	6	EX1080.09.080	50
Pg 9	8.0	10.0	18	25	6	EX1080.09.100	50
Pg 11	5.5	8.5	21	23	6	EX1080.11.085	50
Pg 11	9.5	12.0	21	23	6	EX1080.11.120	50
Pg 13	8.0	11.0	24	25	6	EX1080.13.110	50
Pg 13	12.5	14.0	24	27	6	EX1080.13.140	50
Pg 16	8.0	11.0	24	24	6	EX1080.16.110	50
Pg 16	12.5	14.0	24	27	6	EX1080.16.140	50
Pg 21	13.0	16.0	30	30	7.5	EX1080.21.160	25
Pg 21	17.0	19.0	30	33	7.5	EX1080.21.190	25
Pg 29	19.0	23.0	38	33	8	EX1080.29.230	25
Pg 29	24.0	25.5	38	32	8	EX1080.29.255	25
Pg 36	25.0	30.5	50	36	8	EX1080.36.305	10

Langes Anschlussgewinde auf Anfrage | Long entry thread available on request



Progress MS EMC EX



Kurzes Anschlussgewinde metrisch | Short entry thread metric

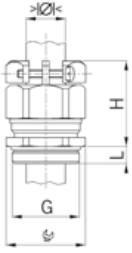

Material: Messing vernickelt
 Schrauben: Rostfreier Stahl A2
 Dichtung: TPE
 O-Ring: FPM
 Schutzart: IP 66 / IP 68 (bis 10 bar)
 Prüfnorm: IEC EN 60079-0 / IEC EN 60079-7 / IEC EN 60079-31
 Gas: II 2G Ex eb IIC Gb
 Staub: II 2D Ex tb IIIC Db
 Zone: Gas 1 und 2 / Staub 21 und 22
 Zertifikat: SEV 15 ATEX 0151
 IECEx Zertifikat: IECEx SEV 15.0018
 Einsatztemperatur: -60 °C / +100 °C

Material: Nickel-plated brass
 Screws: Stainless steel A2
 Seal: TPE
 O-ring: FPM
 Protection class: IP 66 / IP 68 (up to 10 bar)
 Test standard: IEC EN 60079-0 / IEC EN 60079-7 / IEC EN 60079-31
 Gas: II 2G Ex eb IIC Gb
 Dust: II 2D Ex tb IIIC Db
 Zone: Gas 1 and 2 / dust 21 and 22
 Certificate: SEV 15 ATEX 0151
 IECEx Certificate: IECEx SEV 15.0018
 Operation temperature: -60 °C / +100 °C



Progress MS EMC KB EX



Einteiliger Dichteinsatz
 nicht durchgehend isolierend

One-piece sealing insert
 not overall length insulated

G	>Ø< min mm	>Ø< max mm	Ø mm	H mm	L mm	i info	Art.-No.	
M12x1.5	4.5	6.0	15/16	26	5	1	EX1803.80.12.060	50
M12x1.5	6.0	7.5	15/16	26	5	1	EX1803.80.12.075	50
M16x1.5	6.0	8.0	18/19	30	5	-	EX1803.80.17.080	50
M16x1.5	8.0	10.0	18/19	30	5	-	EX1803.80.17.100	50
M20x1.5	8.0	11.0	24	31	6	-	EX1803.80.20.110	50
M20x1.5	11.0	14.0	24	31	6	-	EX1803.80.20.140	50
M25x1.5	13.0	16.0	30	35	7	-	EX1803.80.25.160	25
M25x1.5	16.0	19.0	30	35	7	-	EX1803.80.25.190	25
M32x1.5	18.0	21.0	36	40	8	-	EX1803.80.32.210	25
M32x1.5	21.0	25.0	36	40	8	-	EX1803.80.32.250	25
M40x1.5	24.0	28.5	46	44	8	-	EX1803.80.40.285	10
M40x1.5	28.5	32.0	46	44	8	-	EX1803.80.40.320	10
M50x1.5	33.0	37.0	55	49	9	-	EX1803.80.50.370	10
M50x1.5	37.0	41.0	55	49	9	-	EX1803.80.50.410	10
M63x1.5	40.0	46.0	70	55	10	-	EX1803.80.63.460	5
M63x1.5	46.0	50.0	70	55	10	-	EX1803.80.63.500	5

1 = Zertifikat SEV 15 ATEX 0152X / IECEx SEV 15.0019X

1 = Certificate SEV 15 ATEX 0152X / IECEx SEV 15.0019X

Langes Anschlussgewinde auf Anfrage

Long entry thread available on request

Kurzes Anschlussgewinde Pg | Short entry thread Pg

Material: Messing vernickelt
 Schrauben: Rostfreier Stahl A2
 Dichtung: TPE
 O-Ring: FPM
 Schutzart: IP 66 / IP 68 (bis 10 bar)
 Prüfnorm: IEC EN 60079-0 / IEC EN 60079-7 / IEC EN 60079-31
 Gas: II 2G Ex eb IIC Gb
 Staub: II 2D Ex tb IIIC Db
 Zone: Gas 1 und 2 / Staub 21 und 22
 Zertifikat: SEV 15 ATEX 0151
 IECEx Zertifikat: IECEx SEV 15.0018
 Einsatztemperatur: -60 °C / +100 °C

Material: Nickel-plated brass
 Screws: Stainless steel A2
 Seal: TPE
 O-ring: FPM
 Protection class: IP 66 / IP 68 (up to 10 bar)
 Test standard: IEC EN 60079-0 / IEC EN 60079-7 / IEC EN 60079-31
 Gas: II 2G Ex eb IIC Gb
 Dust: II 2D Ex tb IIIC Db
 Zone: Gas 1 and 2 / dust 21 and 22
 Certificate: SEV 15 ATEX 0151
 IECEx Certificate: IECEx SEV 15.0018
 Operation temperature: -60 °C / +100 °C

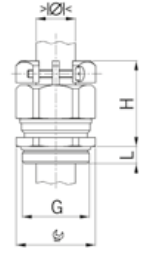

Einteiliger Dichteinsatz nicht durchgehend isolierend		One-piece sealing insert not overall length insulated						
G	>Ø< min mm	>Ø< max mm	Ø mm	H mm	L mm	i info	Art.-No.	
Pg 7	4.5	6.0	15/16	26	6	1	EX1803.80.07.060	50
Pg 7	6.0	7.5	15/16	26	6	1	EX1803.80.07.075	50
Pg 9	6.0	8.0	18/19	30	6	-	EX1803.80.09.080	50
Pg 9	8.0	10.0	18/19	30	6	-	EX1803.80.09.100	50
Pg 11	5.5	8.5	21	31	6	-	EX1803.80.11.085	50
Pg 11	8.5	12.0	21	31	6	-	EX1803.80.11.120	50
Pg 13	8.0	11.0	24	31	6	-	EX1803.80.13.110	50
Pg 13	11.0	14.0	24	31	6	-	EX1803.80.13.140	50
Pg 16	8.0	11.0	24	31	6	-	EX1803.80.16.110	50
Pg 16	11.0	14.0	24	31	6	-	EX1803.80.16.140	50
Pg 21	13.0	16.0	30	35	7.5	-	EX1803.80.21.160	25
Pg 21	16.0	19.0	30	35	7.5	-	EX1803.80.21.190	25
Pg 29	19.0	23.0	38	40	8	-	EX1803.80.29.230	25
Pg 29	23.0	25.5	38	40	8	-	EX1803.80.29.255	25
Pg 36	25.0	30.5	50	47	8	-	EX1803.80.36.305	10
Pg 36	30.5	35.0	50	47	8	-	EX1803.80.36.350	10
Pg 42	33.0	37.0	55	49	10	-	EX1803.80.42.370	10
Pg 42	37.0	41.0	55	49	10	-	EX1803.80.42.410	10
Pg 48	39.0	43.0	65	51	11	-	EX1803.80.48.430	5
Pg 48	43.0	46.5	65	51	11	-	EX1803.80.48.465	5

1 = Zertifikat SEV 15 ATEX 0152X / IECEx SEV 15.0019X 1 = Certificate SEV 15 ATEX 0152X / IECEx SEV 15.0019X
 Langes Anschlussgewinde auf Anfrage Long entry thread available on request



Progress MS EMC KB EX



Kurzes Anschlussgewinde metrisch | Short entry thread metric

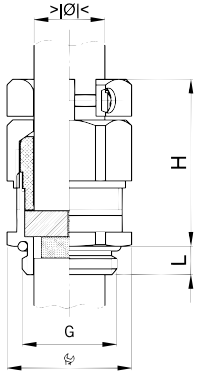

Material: Messing vernickelt
 Schrauben: Rostfreier Stahl A2
 Dichtung: TPE
 O-Ring: FPM
 Schutzart: IP 66 / IP 68
 Prüfnorm: IEC EN 60079-0 / IEC EN 60079-7 / IEC EN 60079-31
 Gas: II 2G Ex eb IIC Gb
 Staub: II 2D Ex tb IIIC Db
 Zone: Gas 1 und 2 / Staub 21 und 22
 Zertifikat: SEV 15 ATEX 0151
 IECEx Zertifikat: IECEx SEV 15.0018
 Einsatztemperatur: -60 °C / +100 °C

Material: Nickel-plated brass
 Screws: Stainless steel A2
 Seal: TPE
 O-ring: FPM
 Protection class: IP 66 / IP 68
 Test standard: IEC EN 60079-0 / IEC EN 60079-7 / IEC EN 60079-31
 Gas: II 2G Ex eb IIC Gb
 Dust: II 2D Ex tb IIIC Db
 Zone: Gas 1 and 2 / dust 21 and 22
 Certificate: SEV 15 ATEX 0151
 IECEx Certificate: IECEx SEV 15.0018
 Operation temperature: -60 °C / +100 °C



Progress MS EMV easyCONNECT KB EX



Zweiteiliger Dichteinsatz
 nicht durchgehend isolierend

Two-piece sealing insert
 not overall length insulated

G	>Ø< min mm	>Ø< max mm	>Ø< min mm	>Ø< max mm	Ø mm	H mm	L mm	i info	Art.-No.	
M12x1.5	-	-	5.0	6.5	15/16	31	5	1/2	EX1803.83.12.065	50
M16x1.5	6.0	8.0	8.0	10.5	18/19	33	5	-	EX1803.83.17	50
M20x1.5	8.0	11.0	11.0	15.0	24	35	6	-	EX1803.83.20	50
M25x1.5	12.5	16.0	16.0	20.5	30	40	7	-	EX1803.83.25	25
M32x1.5	17.0	21.0	21.0	25.5	36	45	8	-	EX1803.83.32	25
M40x1.5	24.0	28.5	28.5	33.0	46	51	8	-	EX1803.83.40	10
M50x1.5	33.0	37.0	37.0	42.0	55	57	9	-	EX1803.83.50	10
M63x1.5	40.0	46.0	46.0	52.0	70	60	10	-	EX1803.83.63	5

1 = Einteiliger Dichteinsatz
 2 = Zertifikat SEV 15 ATEX 0152X / IECEx SEV 15.0019X
 Auf Anfrage lieferbar:
 Anschlussgewinde Pg und NPT
 Ausführungen in Stahl A2 und A4

1 = One-piece sealing insert
 2 = Certificate SEV 15 ATEX 0152X / IECEx SEV 15.0019X
 Available on request:
 Entry thread Pg and NPT
 Executions in steel A2 and A4

Langes Anschlussgewinde metrisch | Long entry thread metric



Progress MS EMV easyCONNECT KB EX



Zweiteiliger Dichteinsatz
 nicht durchgehend isolierend

Two-piece sealing insert
 not overall length insulated

G	>Ø< min mm	>Ø< max mm	>Ø< min mm	>Ø< max mm	Ø mm	H mm	L mm	i info	Art.-No.	
M12x1.5	-	-	5.0	6.5	15/16	31	10	1/2	EX1813.83.12.065	50
M16x1.5	6.0	8.0	8.0	10.5	18/19	33	10	-	EX1813.83.17	50
M20x1.5	8.0	11.0	11.0	15.0	24	35	10	-	EX1813.83.20	50
M25x1.5	12.5	16.0	16.0	20.5	30	40	11	-	EX1813.83.25	25
M32x1.5	17.0	21.0	21.0	25.5	36	45	13	-	EX1813.83.32	25
M40x1.5	24.0	28.5	28.5	33.0	46	51	13	-	EX1813.83.40	10
M50x1.5	33.0	37.0	37.0	42.0	55	57	14	-	EX1813.83.50	10
M63x1.5	40.0	46.0	46.0	52.0	70	60	14	-	EX1813.83.63	5

1 = Einteiliger Dichteinsatz
 2 = Zertifikat SEV 15 ATEX 0152X / IECEx SEV 15.0019X
 Auf Anfrage lieferbar:
 Anschlussgewinde Pg und NPT
 Ausführungen in Stahl A2 und A4

1 = One-piece sealing insert
 2 = Certificate SEV 15 ATEX 0152X / IECEx SEV 15.0019X
 Available on request:
 Entry thread Pg and NPT
 Executions in steel A2 and A4

AGRO Kombi-Schlauchverschraubungen Progress® Messing erhöhte Sicherheit Ex e II

AGRO combination conduit glands Progress® nickel-plated brass increased safety Ex e II

Kurzes Anschlussgewinde metrisch | Short entry thread metric

Material: Messing vernickelt
 Dichtung: TPE
 O-Ring: FPM
 Schutzart: IP 66 / IP 68
 Prüfnorm: IEC EN 60079-0 /
 IEC EN 60079-7 /
 IEC EN 60079-31
 Gas: II 2G Ex eb IIC Gb
 Staub: II 2D Ex tb IIIC Db
 Zone: Gas 1 und 2 /
 Staub 21 und 22
 Zertifikat: SEV 15 ATEX 0152X
 IECEx Zertifikat: IECEx SEV 15.0019X
 Einsatztemperatur: -60 °C / +100 °C

Material: Nickel-plated brass
 Seal: TPE
 O-ring: FPM
 Protection class: IP 66 / IP 68
 Test standard: IEC EN 60079-0 /
 IEC EN 60079-7 /
 IEC EN 60079-31
 Gas: II 2G Ex eb IIC Gb
 Dust: II 2D Ex tb IIIC Db
 Zone: Gas 1 and 2 /
 dust 21 and 22
 Certificate: SEV 15 ATEX 0152X
 IECEx Certificate: IECEx SEV 15.0019X
 Operation temperature: -60 °C / +100 °C

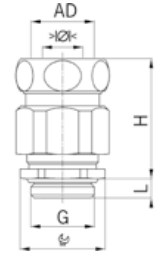

Einteiliger Dichteinsatz
 nicht durchgehend isolierend

One-piece sealing insert
 not overall length insulated

G	AD mm	>Ø< min mm	>Ø< max mm	H mm	L mm	Art.-No.	
M12x1.5	10	4.0	6.5	15/17	33	EX1700.12.10.065	50
M16x1.5	14	4.5	6.0	18/21	38	EX1700.17.14.060	50
M16x1.5	14	6.0	8.0	18/21	38	EX1700.17.14.080	50
M16x1.5	14	8.5	10.5	18/21	38	EX1700.17.14.105	50
M20x1.5	17	6.5	8.0	24/25	38	EX1700.20.17.080	25
M20x1.5	17	9.5	11.0	24/25	38	EX1700.20.17.110	25
M20x1.5	19	6.5	8.0	24/27	39	EX1700.20.19.080	25
M20x1.5	19	9.5	11.0	24/27	39	EX1700.20.19.110	25
M20x1.5	19	12.0	15.0	24/27	39	EX1700.20.19.150	25
M20x1.5	21	6.5	8.0	24/29	39	EX1700.20.21.080	25
M20x1.5	21	9.5	11.0	24/29	39	EX1700.20.21.110	25
M20x1.5	21	12.0	15.0	24/29	39	EX1700.20.21.150	25
M25x1.5	21	10.5	12.5	30/29	43	EX1700.25.21.125	25
M25x1.5	21	13.0	16.0	30/29	43	EX1700.25.21.160	25
M25x1.5	27	10.5	12.5	30/36	50	EX1700.25.27.125	25
M25x1.5	27	13.0	16.0	30/36	50	EX1700.25.27.160	25
M25x1.5	27	17.0	20.5	30/36	50	EX1700.25.27.205	25
M32x1.5	27	19.0	21.0	36/36	52	EX1700.32.27.210	25
M40x1.5	36	25.0	28.5	45/45	56	EX1700.40.36.285	10
M50x1.5	45	35.0	37.0	55/54	60	EX1700.50.45.370	10
M63x1.5	56	44.0	46.0	70/66	67	EX1700.63.56.460	5



Progress MS
 Kombi EX



Langes Anschlussgewinde auf Anfrage

Long entry thread available on request

Je nach Schlauchtyp muss die passende Stabilisierungshülse separat bestellt werden.

Depending on the type of conduit, the stabilising bush must be ordered separately.

Achtung: Es dürfen nur metallische oder metallisch umflochtene Schutzschläuche verwendet werden !

Warning: Only metallic conduits or conduits with metallic braiding may be applied !

Druckausgleichselement mit Membrane erhöhte Sicherheit Ex e II

Pressure balance element with membrane increased safety Ex e II

Anschlussgewinde metrisch | Entry thread metric

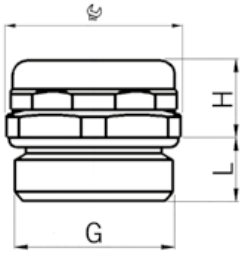

Material: Messing vernickelt
 Membrane: PES Polyethersulfon
 O-Ring: FPM
 Schutzart: IP 66 / IP 68 / IP 69
 Prüfnorm: IEC EN 60079-0 / IEC EN 60079-7 / IEC EN 60079-31
 Gas: II 2G Ex eb IIC Gb
 Staub: II 2D Ex tb IIIC Db
 Zone: Gas 1 und 2 / Staub 21 und 22
 Zertifikat: SEV 16 ATEX 0143
 IECEx Zertifikat: IECEx SEV 16.0010
 Einsatztemperatur: -60 °C / +100 °C

Material: Nickel-plated brass
 Membrane: PES polyethersulfone
 O-ring: FPM
 Protection class: IP 66 / IP 68 / IP 69
 Test standard: IEC EN 60079-0 / IEC EN 60079-7 / IEC EN 60079-31
 Gas: II 2G Ex eb IIC Gb
 Dust: II 2D Ex tb IIIC Db
 Zone: Gas 1 and 2 / dust 21 and 22
 Certificate: SEV 16 ATEX 0143
 IECEx Certificate: IECEx SEV 16.0010
 Operation temperature: -60 °C / +100 °C





EX DAE



mit Membrane
mit O-Ring

with membrane
with O-ring

G	 mm	H mm	L mm	Art.-No.	
M12x1.5	18	9.5	8	EX2450.12.34	25
M16x1.5	18	9.5	8	EX2450.17.34	20
M20x1.5	22	10.0	8	EX2450.20.34	20

Auf Anfrage lieferbar:

Available on request:

Rostfreier Stahl A2 oder A4

Stainless steel A2 or A4

für Multi-Kabelverschraubungen | for multi cable glands

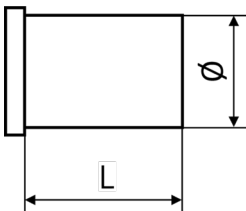

Material: Messing vernickelt
 Einsatzbereich: Zum Verschliessen nicht belegter Bohrungen in Mehrfach-Kabelverschraubungen
 Einsatztemperatur: -60 °C / +100 °C

Material: Nickel-plated brass
 Application: Usable as inserts to close unused holes in sealings of multi-duct cable glands
 Operation temperature: -60 °C / +100 °C



Verschlussbolzen zu Kabelverschraubungen

Locking pins for cable glands

$\frac{>\text{Ø}<}{\text{mm}}$	L mm	Art.-No.	
1.5	6	EX1310.015.07	25
3	7	EX1310.030.07	25
4	7	EX1310.040.07	25
5	7	EX1310.050.07	25
6	7	EX1310.060.07	25
7	7	EX1310.070.07	25
9	9	EX1310.090.07	25
10	9	EX1310.100.07	25
12	11	EX1310.120.07	25
15	11	EX1310.150.07	25
18	12	EX1310.180.07	25

Einsetzbar auch für Ex Multi-Kabelverschraubungen

Can also be used for Ex multi cable glands

AGRO Kabelverschraubungen Progress® Kunststoff GFK erhöhte Sicherheit Ex e II

AGRO synthetic cable glands Progress® GFK increased safety Ex e II

Anschlussgewinde metrisch | Entry thread metric

Material:	Polyamid glasfaserverstärkt	Material:	Polyamide glass fiber reinforced
Eigenschaften:	halogenfrei	Properties:	halogen-free
Dichtung:	TPE / NBR	Seal:	TPE / NBR
Schutzart:	IP 66 / IP 68	Protection class:	IP 66 / IP 68
Prüfnorm:	IEC EN 60079-0 / IEC EN 60079-7 / IEC EN 60079-31	Test standard:	IEC EN 60079-0 / IEC EN 60079-7 / IEC EN 60079-31
Gas:	II 2G Ex eb IIC Gb	Gas:	II 2G Ex eb IIC Gb
Staub:	II 2D Ex tb IIIC Db	Dust:	II 2D Ex tb IIIC Db
Zone:	Gas 1 und 2 / Staub 21 und 22	Zone:	Gas 1 and 2 / dust 21 and 22
Zertifikat:	SEV 15 ATEX 0152X	Certificate:	SEV 15 ATEX 0152X
IECEx Zertifikat:	IECEx SEV 15.0019X	IECEx Certificate:	IECEx SEV 15.0019X
Einsatztemperatur:	-20 °C / +85 °C	Operation temperature:	-20 °C / +85 °C

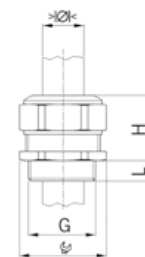

Hellgrau RAL 7035
Einteiliger Dichteinsatz

Light grey RAL 7035
One-piece sealing insert

G	>Ø< min mm	>Ø< max mm	mm	H mm	L mm	i info	Art.-No.	
M16x1.5	4.5	6.0	21	26	12	-	EX1571.17.060	50
M16x1.5	6.0	8.0	21	26	12	-	EX1571.17.080	50
M20x1.5	6.0	8.0	27	28	13	-	EX1571.20.080	50
M20x1.5	8.0	11.0	27	28	13	-	EX1571.20.110	50
M25x1.5	9.5	12.5	34	33	13	-	EX1571.25.125	25
M25x1.5	12.5	16.0	34	33	13	-	EX1571.25.160	25
M25x1.5	16.0	19.0	34	33	13	-	EX1571.25.190	25
M25x1.5	19.0	20.5	34	33	13	-	EX1571.25.205	25
M32x1.5	20.0	21.0	41	35	15	-	EX1571.32.210	25
M32x1.5	21.0	22.0	41	35	15	3	EX1571.32.220	25
M32x1.5	22.0	23.0	41	35	15	3	EX1571.32.230	25
M32x1.5	23.0	25.5	41	35	15	-	EX1571.32.255	25
M40x1.5	25.5	27.0	50	40	15	3	EX1571.40.270	10
M40x1.5	27.0	28.5	50	40	15	-	EX1571.40.285	10
M40x1.5	28.5	30.0	50	40	15	3	EX1571.40.300	10
M40x1.5	30.0	33.0	50	40	15	-	EX1571.40.330	10
M50x1.5	33.0	35.0	60	42	16	3	EX1571.50.350	10
M50x1.5	35.0	37.0	60	42	16	-	EX1571.50.370	10
M50x1.5	37.0	39.0	60	42	16	3	EX1571.50.390	10
M50x1.5	39.0	42.0	60	42	16	-	EX1571.50.420	10
M63x1.5	42.0	44.0	75	48	16	3	EX1571.63.440	5
M63x1.5	44.0	46.0	75	48	16	-	EX1571.63.460	5
M63x1.5	46.0	48.0	75	48	16	3	EX1571.63.480	5
M63x1.5	48.0	52.0	75	48	16	-	EX1571.63.520	5

3 = Material Dichteinsatz NBR

3 = Material sealing insert NBR



Progress GFK EX



Anschlussgewinde metrisch | Entry thread metric

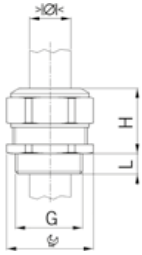

Material: Polyamid glasfaserverstärkt

Eigenschaften: halogenfrei

Dichtung: TPE / NBR

Schutzart: IP 66 / IP 68

Prüfnorm: IEC EN 60079-0 / IEC EN 60079-7 / IEC EN 60079-31

Gas: II 2G Ex eb IIC Gb

Staub: II 2D Ex tb IIIC Db

Zone: Gas 1 und 2 / Staub 21 und 22

Zertifikat: SEV 15 ATEX 0152X

IECEX Zertifikat: IECEX SEV 15.0019X

Einsatztemperatur: -20 °C / +85 °C

Material: Polyamide glass fiber reinforced

Properties: halogen-free

Seal: TPE / NBR

Protection class: IP 66 / IP 68

Test standard: IEC EN 60079-0 / IEC EN 60079-7 / IEC EN 60079-31

Gas: II 2G Ex eb IIC Gb

Dust: II 2D Ex tb IIIC Db

Zone: Gas 1 and 2 / dust 21 and 22

Certificate: SEV 15 ATEX 0152X

IECEX Certificate: IECEX SEV 15.0019X

Operation temperature: -20 °C / +85 °C



Progress GFK EX



Schwarz RAL 9005
Einteiliger Dichteinsatz

Black RAL 9005
One-piece sealing insert

G	>Ø< min mm	>Ø< max mm	Ø mm	H mm	L mm	i info	Art.-No.	
M16x1.5	4.5	6.0	21	26	12	-	EX1540.17.060	50
M16x1.5	6.0	8.0	21	26	12	-	EX1540.17.080	50
M20x1.5	6.0	8.0	27	28	13	-	EX1540.20.080	50
M20x1.5	8.0	11.0	27	28	13	-	EX1540.20.110	50
M25x1.5	9.5	12.5	34	33	13	-	EX1540.25.125	25
M25x1.5	12.5	16.0	34	33	13	-	EX1540.25.160	25
M25x1.5	16.0	19.0	34	33	13	-	EX1540.25.190	25
M25x1.5	19.0	20.5	34	33	13	-	EX1540.25.205	25
M32x1.5	20.0	21.0	41	35	15	-	EX1540.32.210	25
M32x1.5	21.0	22.0	41	35	15	3	EX1540.32.220	25
M32x1.5	22.0	23.0	41	35	15	3	EX1540.32.230	25
M32x1.5	23.0	25.5	41	35	15	-	EX1540.32.255	25
M40x1.5	25.5	27.0	50	40	15	3	EX1540.40.270	10
M40x1.5	27.0	28.5	50	40	15	-	EX1540.40.285	10
M40x1.5	28.5	30.0	50	40	15	3	EX1540.40.300	10
M40x1.5	30.0	33.0	50	40	15	-	EX1540.40.330	10
M50x1.5	33.0	35.0	60	42	16	3	EX1540.50.350	10
M50x1.5	35.0	37.0	60	42	16	-	EX1540.50.370	10
M50x1.5	37.0	39.0	60	42	16	3	EX1540.50.390	10
M50x1.5	39.0	42.0	60	42	16	-	EX1540.50.420	10
M63x1.5	42.0	44.0	75	48	16	3	EX1540.63.440	5
M63x1.5	44.0	46.0	75	48	16	-	EX1540.63.460	5
M63x1.5	46.0	48.0	75	48	16	3	EX1540.63.480	5
M63x1.5	48.0	52.0	75	48	16	-	EX1540.63.520	5

3 = Material Dichteinsatz NBR

3 = Material sealing insert NBR

AGRO Kabelverschraubungen Progress® Kunststoff GFK erhöhte Sicherheit Ex e II

AGRO synthetic cable glands Progress® GFK increased safety Ex e II

Anschlussgewinde Pg | Entry thread Pg

Material:	Polyamid glasfaserverstärkt	Material:	Polyamide glass fiber reinforced
Eigenschaften:	halogenfrei	Properties:	halogen-free
Dichtung:	TPE / NBR	Seal:	TPE / NBR
Schutzart:	IP 66 / IP 68	Protection class:	IP 66 / IP 68
Prüfnorm:	IEC EN 60079-0 / IEC EN 60079-7 / IEC EN 60079-31	Test standard:	IEC EN 60079-0 / IEC EN 60079-7 / IEC EN 60079-31
Gas:	II 2G Ex eb IIC Gb	Gas:	II 2G Ex eb IIC Gb
Staub:	II 2D Ex tb IIIC Db	Dust:	II 2D Ex tb IIIC Db
Zone:	Gas 1 und 2 / Staub 21 und 22	Zone:	Gas 1 and 2 / dust 21 and 22
Zertifikat:	SEV 15 ATEX 0152X	Certificate:	SEV 15 ATEX 0152X
IECEx Zertifikat:	IECEx SEV 15.0019X	IECEx Certificate:	IECEx SEV 15.0019X
Einsatztemperatur:	-20 °C / +85 °C	Operation temperature:	-20 °C / +85 °C

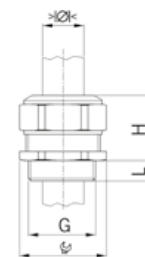

Hellgrau RAL 7035
Einteiliger Dichteinsatz

Light grey RAL 7035
One-piece sealing insert

G	>Ø< min mm	>Ø< max mm	mm	H mm	L mm	i info	Art.-No.	
Pg 9	4.5	6.0	21	26	12	-	EX1571.09.060	50
Pg 9	6.0	8.0	21	26	12	-	EX1571.09.080	50
Pg 11	4.0	5.5	24	28	12	-	EX1571.11.055	50
Pg 11	5.5	8.5	24	28	12	-	EX1571.11.085	50
Pg 13	6.0	8.0	27	28	13	-	EX1571.13.080	50
Pg 13	8.0	11.0	27	28	13	-	EX1571.13.110	50
Pg 16	6.0	8.0	27	28	13	-	EX1571.16.080	50
Pg 16	8.0	11.0	27	28	13	-	EX1571.16.110	50
Pg 21	9.5	12.5	34	33	13	-	EX1571.21.125	25
Pg 21	12.5	16.0	34	33	13	-	EX1571.21.160	25
Pg 21	16.0	19.0	34	33	13	-	EX1571.21.190	25
Pg 21	19.0	20.5	34	33	13	-	EX1571.21.205	25
Pg 29	19.5	21.0	41	36	13	3	EX1571.29.210	25
Pg 29	21.0	23.0	41	36	13	-	EX1571.29.230	25
Pg 29	23.0	25.0	41	36	13	3	EX1571.29.250	25
Pg 29	25.0	27.5	41	36	13	-	EX1571.29.275	25
Pg 36	27.0	28.5	55	42	16	3	EX1571.36.285	10
Pg 36	28.5	30.5	55	42	16	-	EX1571.36.305	10
Pg 36	30.5	32.5	55	42	16	3	EX1571.36.325	10
Pg 36	32.5	35.0	55	42	16	-	EX1571.36.350	10
Pg 42	33.0	35.0	60	42	16	3	EX1571.42.350	10
Pg 42	35.0	37.0	60	42	16	-	EX1571.42.370	10
Pg 42	37.0	39.0	60	42	16	3	EX1571.42.390	10
Pg 42	39.0	42.0	60	42	16	-	EX1571.42.420	10
Pg 48	41.0	43.0	70	46	16	-	EX1571.48.430	5
Pg 48	43.0	45.0	70	46	16	3	EX1571.48.450	5
Pg 48	45.0	47.0	70	46	16	3	EX1571.48.470	5
Pg 48	47.0	49.0	70	46	16	-	EX1571.48.490	5

3 = Material Dichteinsatz NBR

3 = Material sealing insert NBR



Progress GFK EX



Anschlussgewinde Pg | Entry thread Pg

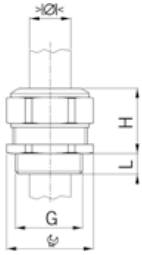

Material: Polyamid glasfaserverstärkt
 Eigenschaften: halogenfrei
 Dichtung: TPE / NBR
 Schutzart: IP 66 / IP 68
 Prüfnorm: IEC EN 60079-0 / IEC EN 60079-7 / IEC EN 60079-31
 Gas: II 2G Ex eb IIC Gb
 Staub: II 2D Ex tb IIIC Db
 Zone: Gas 1 und 2 / Staub 21 und 22
 Zertifikat: SEV 15 ATEX 0152X
 IECEx Zertifikat: IECEx SEV 15.0019X
 Einsatztemperatur: -20 °C / +85 °C

Material: Polyamide glass fiber reinforced
 Properties: halogen-free
 Seal: TPE / NBR
 Protection class: IP 66 / IP 68
 Test standard: IEC EN 60079-0 / IEC EN 60079-7 / IEC EN 60079-31
 Gas: II 2G Ex eb IIC Gb
 Dust: II 2D Ex tb IIIC Db
 Zone: Gas 1 and 2 / dust 21 and 22
 Certificate: SEV 15 ATEX 0152X
 IECEx Certificate: IECEx SEV 15.0019X
 Operation temperature: -20 °C / +85 °C



Progress GFK EX



Schwarz RAL 9005
 Einteiliger Dichteinsatz

Black RAL 9005
 One-piece sealing insert

G	>Øk< min mm	>Øk< max mm	Ø mm	H mm	L mm	i info	Art.-No.	
Pg 9	4.5	6.0	21	26	12	-	EX1540.09.060	50
Pg 9	6.0	8.0	21	26	12	-	EX1540.09.080	50
Pg 11	4.0	5.5	24	28	12	-	EX1540.11.055	50
Pg 11	5.5	8.5	24	28	12	-	EX1540.11.085	50
Pg 13	6.0	8.0	27	28	13	-	EX1540.13.080	50
Pg 13	8.0	11.0	27	28	13	-	EX1540.13.110	50
Pg 16	6.0	8.0	27	28	13	-	EX1540.16.080	50
Pg 16	8.0	11.0	27	28	13	-	EX1540.16.110	50
Pg 21	9.5	12.5	34	33	13	-	EX1540.21.125	25
Pg 21	12.5	16.0	34	33	13	-	EX1540.21.160	25
Pg 21	16.0	19.0	34	33	13	-	EX1540.21.190	25
Pg 21	19.0	20.5	34	33	13	-	EX1540.21.205	25
Pg 29	19.5	21.0	41	36	13	3	EX1540.29.210	25
Pg 29	21.0	23.0	41	36	13	-	EX1540.29.230	25
Pg 29	23.0	25.0	41	36	13	3	EX1540.29.250	25
Pg 29	25.0	27.5	41	36	13	-	EX1540.29.275	25
Pg 36	27.0	28.5	55	42	16	3	EX1540.36.285	10
Pg 36	28.5	30.5	55	42	16	-	EX1540.36.305	10
Pg 36	30.5	32.5	55	42	16	3	EX1540.36.325	10
Pg 36	32.5	35.0	55	42	16	-	EX1540.36.350	10
Pg 42	33.0	35.0	60	42	16	3	EX1540.42.350	10
Pg 42	35.0	37.0	60	42	16	-	EX1540.42.370	10
Pg 42	37.0	39.0	60	42	16	3	EX1540.42.390	10
Pg 42	39.0	42.0	60	42	16	-	EX1540.42.420	10
Pg 48	41.0	43.0	70	46	16	-	EX1540.48.430	5
Pg 48	43.0	45.0	70	46	16	3	EX1540.48.450	5
Pg 48	45.0	47.0	70	46	16	3	EX1540.48.470	5
Pg 48	47.0	49.0	70	46	16	-	EX1540.48.490	5

3 = Material Dichteinsatz NBR

3 = Material sealing insert NBR

Anschlussgewinde metrisch | Entry thread metric

Material:	Polyamid glasfaserverstärkt	Material:	Polyamide glass fiber reinforced
Eigenschaften:	halogenfrei	Properties:	halogen-free
Dichtung:	TPE / NBR	Seal:	TPE / NBR
Schutzart:	IP 66 / IP 68	Protection class:	IP 66 / IP 68
Prüfnorm:	IEC EN 60079-0 / IEC EN 60079-7 / IEC EN 60079-31	Test standard:	IEC EN 60079-0 / IEC EN 60079-7 / IEC EN 60079-31
Gas:	II 2G Ex eb IIC Gb	Gas:	II 2G Ex eb IIC Gb
Staub:	II 2D Ex tb IIIC Db	Dust:	II 2D Ex tb IIIC Db
Zone:	Gas 1 und 2 / Staub 21 und 22	Zone:	Gas 1 and 2 / dust 21 and 22
Zertifikat:	SEV 15 ATEX 0152X	Certificate:	SEV 15 ATEX 0152X
IECEx Zertifikat:	IECEx SEV 15.0019X	IECEx Certificate:	IECEx SEV 15.0019X
Einsatztemperatur:	-20 °C / +85 °C	Operation temperature:	-20 °C / +85 °C

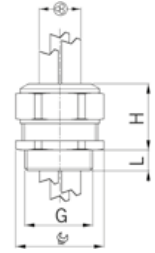

Hellgrau RAL 7035 Einteiliger Dichteinsatz		Light grey RAL 7035 One-piece sealing insert								
G	$\begin{matrix} >101< \\ \text{min mm} \end{matrix}$	$\begin{matrix} >101< \\ \text{max mm} \end{matrix}$	$\begin{matrix} \text{3} \\ \text{mm} \end{matrix}$	$\begin{matrix} \text{H} \\ \text{mm} \end{matrix}$	$\begin{matrix} \text{L} \\ \text{mm} \end{matrix}$	i info	Art.-No.			
M16x1.5	1.0	1.5	4	21	26	12	3	EX1571.17.4.015	50	
M16x1.5	2.0	3.0	2	21	26	12	-	EX1571.17.2.030	50	
M20x1.5	2.5	3.0	6	27	28	13	-	EX1571.20.6.030	50	
M20x1.5	3.5	5.0	2	27	28	13	-	EX1571.20.2.050	50	
M25x1.5	5.0	6.0	6	34	33	13	-	EX1571.25.6.060	25	
M25x1.5	5.5	7.0	4	34	33	13	-	EX1571.25.4.070	25	
M25x1.5	7.5	9.0	3	34	33	13	-	EX1571.25.3.090	25	
M25x1.5	8.0	10.0	2	34	33	13	-	EX1571.25.2.100	25	
M32x1.5	6.0	7.0	6	41	35	15	-	EX1571.32.6.070	25	
M32x1.5	7.5	9.0	4	41	35	15	-	EX1571.32.4.090	25	
M40x1.5	8.0	9.0	7	50	40	15	3	EX1571.40.7.090	10	
M40x1.5	14.0	15.0	2	50	40	15	3	EX1571.40.2.150	10	
M50x1.5	9.0	10.0	4	60	42	16	3	EX1571.50.4.100	10	
M63x1.5	11.0	12.0	6	75	48	16	3	EX1571.63.6.120	5	
M63x1.5	17.0	18.0	3	75	48	16	3	EX1571.63.3.180	5	
3 = Material Dichteinsatz NBR				3 = Material sealing insert NBR						
Passende Verschlussbolzen siehe Zubehör				Suitable locking pins see accessories						



Progress GFK
Multi EX



Schwarz RAL 9005 Einteiliger Dichteinsatz		Black RAL 9005 One-piece sealing insert								
G	$\begin{matrix} >101< \\ \text{min mm} \end{matrix}$	$\begin{matrix} >101< \\ \text{max mm} \end{matrix}$	$\begin{matrix} \text{3} \\ \text{mm} \end{matrix}$	$\begin{matrix} \text{H} \\ \text{mm} \end{matrix}$	$\begin{matrix} \text{L} \\ \text{mm} \end{matrix}$	i info	Art.-No.			
M16x1.5	1.0	1.5	4	21	26	12	3	EX1540.17.4.015	50	
M16x1.5	2.0	3.0	2	21	26	12	-	EX1540.17.2.030	50	
M20x1.5	2.5	3.0	6	27	28	13	-	EX1540.20.6.030	50	
M20x1.5	3.5	5.0	2	27	28	13	-	EX1540.20.2.050	50	
M25x1.5	5.0	6.0	6	34	33	13	-	EX1540.25.6.060	25	
M25x1.5	5.5	7.0	4	34	33	13	-	EX1540.25.4.070	25	
M25x1.5	7.5	9.0	3	34	33	13	-	EX1540.25.3.090	25	
M25x1.5	8.0	10.0	2	34	33	13	-	EX1540.25.2.100	25	
M32x1.5	6.0	7.0	6	41	33	13	-	EX1540.32.6.070	25	
M32x1.5	7.5	9.0	4	41	35	15	-	EX1540.32.4.090	25	
M40x1.5	8.0	9.0	7	50	40	15	3	EX1540.40.7.090	10	
M40x1.5	14.0	15.0	2	50	40	15	3	EX1540.40.2.150	10	
M50x1.5	9.0	10.0	4	60	42	16	3	EX1540.50.4.100	10	
M63x1.5	11.0	12.0	6	75	48	16	3	EX1540.63.6.120	5	
M63x1.5	17.0	18.0	3	75	48	16	3	EX1540.63.3.180	5	
3 = Material Dichteinsatz NBR				3 = Material sealing insert NBR						
Passende Verschlussbolzen siehe Zubehör				Suitable locking pins see accessories						



Progress GFK
Multi EX



Anschlussgewinde Pg | Entry thread Pg

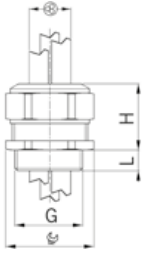

Material: Polyamid glasfaserverstärkt
 Eigenschaften: halogenfrei
 Dichtung: TPE / NBR
 Schutzart: IP 66 / IP 68
 Prüfnorm: IEC EN 60079-0 / IEC EN 60079-7 / IEC EN 60079-31
 Gas: II 2G Ex eb IIC Gb
 Staub: II 2D Ex tb IIIC Db
 Zone: Gas 1 und 2 / Staub 21 und 22
 Zertifikat: SEV 15 ATEX 0152X
 IECEx Zertifikat: IECEx SEV 15.0019X
 Einsatztemperatur: -20 °C / +85 °C

Material: Polyamide glass fiber reinforced
 Properties: halogen-free
 Seal: TPE / NBR
 Protection class: IP 66 / IP 68
 Test standard: IEC EN 60079-0 / IEC EN 60079-7 / IEC EN 60079-31
 Gas: II 2G Ex eb IIC Gb
 Dust: II 2D Ex tb IIIC Db
 Zone: Gas 1 and 2 / dust 21 and 22
 Certificate: SEV 15 ATEX 0152X
 IECEx Certificate: IECEx SEV 15.0019X
 Operation temperature: -20 °C / +85 °C



Progress GFK
Multi EX



Hellgrau RAL 7035
Einteiliger Dichteinsatz

Light grey RAL 7035
One-piece sealing insert

G	>Ø< min mm	>Ø< max mm	⊗ mm	H mm	L mm	i info	Art.-No.	
Pg 9	1.0	1.5	4	21	26	12	EX1571.09.4.015	50
Pg 9	2.0	3.0	2	21	26	12	EX1571.09.2.030	50
Pg 11	3.5	5.0	2	24	28	12	EX1571.11.2.050	50
Pg 11	2.0	3.0	3	24	28	12	EX1571.11.3.030	50
Pg 13	2.5	4.0	3	27	28	13	EX1571.13.3.040	50
Pg 13	3.5	5.0	2	27	28	13	EX1571.13.2.050	50
Pg 16	2.5	3.0	6	27	28	13	EX1571.16.6.030	50
Pg 16	4.5	6.0	3	27	28	13	EX1571.16.3.060	50
Pg 21	5.5	7.0	4	34	33	13	EX1571.21.4.070	25
Pg 21	7.5	9.0	3	34	33	13	EX1571.21.3.090	25
Pg 29	5.5	6.5	6	41	36	13	EX1571.29.6.065	25
Pg 29	8.0	9.0	3	41	36	13	EX1571.29.3.090	25
Pg 36	9.0	10.0	4	55	42	16	EX1571.36.4.100	10
Pg 36	14.0	15.0	2	55	42	16	EX1571.36.2.150	10
Pg 42	9.0	10.0	4	60	42	16	EX1571.42.4.100	10
Pg 48	11.0	12.0	6	70	46	16	EX1571.48.6.120	5
Pg 48	17.0	18.0	3	70	46	16	EX1571.48.3.180	5

3 = Material Dichteinsatz NBR

3 = Material sealing insert NBR

Anschlussgewinde Pg | Entry thread Pg

Material:	Polyamid glasfaserverstärkt	Material:	Polyamide glass fiber reinforced
Eigenschaften:	halogenfrei	Properties:	halogen-free
Dichtung:	TPE / NBR	Seal:	TPE / NBR
Schutzart:	IP 66 / IP 68	Protection class:	IP 66 / IP 68
Prüfnorm:	IEC EN 60079-0 / IEC EN 60079-7 / IEC EN 60079-31	Test standard:	IEC EN 60079-0 / IEC EN 60079-7 / IEC EN 60079-31
Gas:	II 2G Ex eb IIC Gb	Gas:	II 2G Ex eb IIC Gb
Staub:	II 2D Ex tb IIIC Db	Dust:	II 2D Ex tb IIIC Db
Zone:	Gas 1 und 2 / Staub 21 und 22	Zone:	Gas 1 and 2 / dust 21 and 22
Zertifikat:	SEV 15 ATEX 0152X	Certificate:	SEV 15 ATEX 0152X
IECEx Zertifikat:	IECEx SEV 15.0019X	IECEx Certificate:	IECEx SEV 15.0019X
Einsatztemperatur:	-20 °C / +85 °C	Operation temperature:	-20 °C / +85 °C

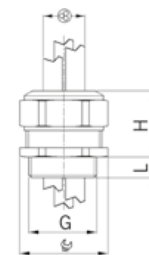

Schwarz RAL 9005 Einteiliger Dichteinsatz		Black RAL 9005 One-piece sealing insert							
G	> Ø < min mm	> Ø < max mm	⊗ mm	H mm	L mm	i info	Art.-No.		
Pg 9	1.0	1.5	4	21	26	12	3	EX1540.09.4.015	50
Pg 9	2.0	3.0	2	21	26	12	-	EX1540.09.2.030	50
Pg 11	2.0	3.0	3	24	28	12	3	EX1540.11.3.030	50
Pg 11	3.5	5.0	2	24	28	12	-	EX1540.11.2.050	50
Pg 13	2.5	4.0	3	27	28	13	3	EX1540.13.3.040	50
Pg 13	3.5	5.0	2	27	28	13	-	EX1540.13.2.050	50
Pg 16	2.5	3.0	6	27	28	13	-	EX1540.16.6.030	50
Pg 16	4.5	6.0	3	27	28	13	-	EX1540.16.3.060	50
Pg 21	5.5	7.0	4	34	33	13	-	EX1540.21.4.070	25
Pg 21	7.5	9.0	3	34	33	13	-	EX1540.21.3.090	25
Pg 29	5.5	6.5	6	41	36	13	3	EX1540.29.6.065	25
Pg 29	8.0	9.0	3	41	36	13	3	EX1540.29.3.090	25
Pg 36	14.0	15.0	2	55	42	16	3	EX1540.36.2.150	10
Pg 36	9.0	10.0	4	55	42	16	3	EX1540.36.4.100	10
Pg 42	9.0	10.0	4	60	42	16	3	EX1540.42.4.100	10
Pg 48	11.0	12.0	6	70	46	16	3	EX1540.48.6.120	5
Pg 48	17.0	18.0	3	70	46	16	3	EX1540.48.3.180	5



Progress GFK
Multi EX



Anschlussgewinde metrisch | Entry thread metric

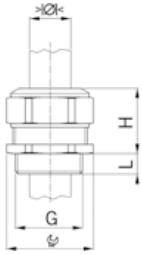

Material: Polyamid glasfaserverstärkt
 Eigenschaften: halogenfrei
 Dichtung: TPE / NBR
 Schutzart: IP 66 / IP 68
 Prüfnorm: IEC EN 60079-0 / IEC EN 60079-7 / IEC EN 60079-31
 Gas: II 2G Ex eb IIC Gb
 Staub: II 2D Ex tb IIIC Db
 Eigensicherheit Gas: II 2G Ex ia IIC Ga
 Eigensicherheit Staub: II 2D Ex ia IIIC Da
 Zone: Gas 0, 1 und 2 / Staub 20, 21 und 22
 Zertifikat: SEV 15 ATEX 0152X
 IECEx Zertifikat: IECEx SEV 15.0019X
 Einsatztemperatur: -20 °C / +85 °C

Material: Polyamide glass fiber reinforced
 Properties: halogen-free
 Seal: TPE / NBR
 Protection class: IP 66 / IP 68
 Test standard: IEC EN 60079-0 / IEC EN 60079-7 / IEC EN 60079-31
 Gas: II 2G Ex eb IIC Gb
 Dust: II 2D Ex tb IIIC Db
 Intrinsic safety gas: II 2G Ex ia IIC Ga
 Intrinsic safety dust: II 2D Ex ia IIIC Da
 Zone: Gas 0, 1 and 2 / dust 20, 21 and 22
 Certificate: SEV 15 ATEX 0152X
 IECEx Certificate: IECEx SEV 15.0019X
 Operation temperature: -20 °C / +85 °C



Progress GFK EX



Schwarz / Lichtblau RAL 5012
 Einteiliger Dichteinsatz

Black / light blue RAL 5012
 One-piece sealing insert

G	>Ø< min mm	>Ø< max mm	Ø mm	H mm	L mm	i info	Art.-No.	
M16x1.5	4.5	6.0	21	26	12	-	EX1530.17.060	50
M16x1.5	6.0	8.0	21	26	12	-	EX1530.17.080	50
M20x1.5	6.0	8.0	27	28	13	-	EX1530.20.080	50
M20x1.5	8.0	11.0	27	28	13	-	EX1530.20.110	50
M25x1.5	9.5	12.5	34	33	13	-	EX1530.25.125	25
M25x1.5	12.5	16.0	34	33	13	-	EX1530.25.160	25
M25x1.5	16.0	19.0	34	33	13	-	EX1530.25.190	25
M25x1.5	19.0	20.5	34	33	13	-	EX1530.25.205	25
M32x1.5	20.0	21.0	41	35	15	-	EX1530.32.210	25
M32x1.5	21.0	22.0	41	35	15	3	EX1530.32.220	25
M32x1.5	22.0	23.0	41	35	15	3	EX1530.32.230	25
M32x1.5	23.0	25.5	41	35	15	-	EX1530.32.255	25
M40x1.5	25.5	27.0	50	40	15	3	EX1530.40.270	10
M40x1.5	27.0	28.5	50	40	15	-	EX1530.40.285	10
M40x1.5	28.5	30.0	50	40	15	3	EX1530.40.300	10
M40x1.5	30.0	33.0	50	40	15	-	EX1530.40.330	10
M50x1.5	33.0	35.0	60	42	16	3	EX1530.50.350	10
M50x1.5	35.0	37.0	60	42	16	-	EX1530.50.370	10
M50x1.5	37.0	39.0	60	42	16	3	EX1530.50.390	10
M50x1.5	39.0	42.0	60	42	16	-	EX1530.50.420	10
M63x1.5	42.0	44.0	75	48	16	3	EX1530.63.440	5
M63x1.5	44.0	46.0	75	48	16	-	EX1530.63.460	5
M63x1.5	46.0	48.0	75	48	16	3	EX1530.63.480	5
M63x1.5	48.0	52.0	75	48	16	-	EX1530.63.520	5

3 = Material Dichteinsatz NBR

3 = Material sealing insert NBR

Auf Anfrage lieferbar:

Available on request:

Für mehrere Kabel

For installation of multiple cables

Anschlussgewinde Pg | Entry thread Pg

Material:	Polyamid glasfaserverstärkt	Material:	Polyamide glass fiber reinforced
Eigenschaften:	halogenfrei	Properties:	halogen-free
Dichtung:	TPE / NBR	Seal:	TPE / NBR
Schutzart:	IP 66 / IP 68	Protection class:	IP 66 / IP 68
Prüfnorm:	IEC EN 60079-0 / IEC EN 60079-7 / IEC EN 60079-31	Test standard:	IEC EN 60079-0 / IEC EN 60079-7 / IEC EN 60079-31
Gas:	II 2G Ex eb IIC Gb	Gas:	II 2G Ex eb IIC Gb
Staub:	II 2D Ex tb IIIC Db	Dust:	II 2D Ex tb IIIC Db
Eigensicherheit Gas:	II 2G Ex ia IIC Ga	Intrinsic safety gas:	II 2G Ex ia IIC Ga
Eigensicherheit Staub:	II 2D Ex ia IIIC Da	Intrinsic safety dust:	II 2D Ex ia IIIC Da
Zone:	Gas 0, 1 und 2 / Staub 20, 21 und 22	Zone:	Gas 0, 1 and 2 / dust 20, 21 and 22
Zertifikat:	SEV 15 ATEX 0152X	Certificate:	SEV 15 ATEX 0152X
IECEx Zertifikat:	IECEx SEV 15.0019X	IECEx Certificate:	IECEx SEV 15.0019X
Einsatztemperatur:	-20 °C / +85 °C	Operation temperature:	-20 °C / +85 °C

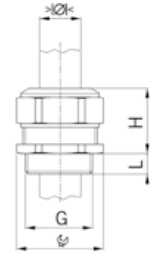

Schwarz / Lichtblau RAL 5012
Einteiliger Dichteinsatz

Black / light blue RAL 5012
One-piece sealing insert

G				H	L	i	Art.-No.	
	min mm	max mm	mm	mm	mm	info		
Pg 9	4.5	6.0	21	26	12	-	EX1530.09.060	50
Pg 9	6.0	8.0	21	26	12	-	EX1530.09.080	50
Pg 11	4.0	5.5	24	28	12	-	EX1530.11.055	50
Pg 11	5.5	8.5	24	28	12	-	EX1530.11.085	50
Pg 13	6.0	8.0	27	28	13	-	EX1530.13.080	50
Pg 13	8.0	11.0	27	28	13	-	EX1530.13.110	50
Pg 16	6.0	8.0	27	28	13	-	EX1530.16.080	50
Pg 16	8.0	11.0	27	28	13	-	EX1530.16.110	50
Pg 21	9.5	12.5	34	33	13	-	EX1530.21.125	25
Pg 21	12.5	16.0	34	33	13	-	EX1530.21.160	25
Pg 21	16.0	19.0	34	33	13	-	EX1530.21.190	25
Pg 21	19.0	20.5	34	33	13	-	EX1530.21.205	25
Pg 29	19.5	21.0	41	36	13	3	EX1530.29.210	25
Pg 29	21.0	23.0	41	36	13	-	EX1530.29.230	25
Pg 29	23.0	25.0	41	36	13	3	EX1530.29.250	25
Pg 29	25.0	27.5	41	36	13	-	EX1530.29.275	25
Pg 36	27.0	28.5	55	42	16	3	EX1530.36.285	10
Pg 36	28.5	30.5	55	42	16	-	EX1530.36.305	10
Pg 36	30.5	32.5	55	42	16	3	EX1530.36.325	10
Pg 36	32.5	35.0	55	42	16	-	EX1530.36.350	10
Pg 42	33.0	35.0	60	42	16	3	EX1530.42.350	10
Pg 42	35.0	37.0	60	42	16	-	EX1530.42.370	10
Pg 42	37.0	39.0	60	42	16	3	EX1530.42.390	10
Pg 42	39.0	42.0	60	42	16	-	EX1530.42.420	10
Pg 48	41.0	43.0	70	46	16	-	EX1530.48.430	5
Pg 48	43.0	45.0	70	46	16	3	EX1530.48.450	5
Pg 48	45.0	47.0	70	46	16	3	EX1530.48.470	5
Pg 48	47.0	49.0	70	46	16	-	EX1530.48.490	5



Progress GFK EX



3 = Material Dichteinsatz NBR

3 = Material sealing insert NBR

Auf Anfrage lieferbar:

Available on request:

Für mehrere Kabel

For installation of multiple cables

Reduktionen Messing erhöhte Sicherheit Ex e II

Reduction fittings nickel-plated brass increased safety Ex e II

Zubehör | Accessories

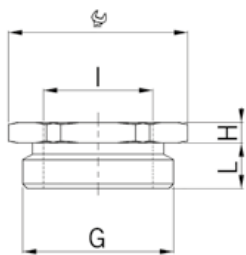

Material: Messing vernickelt
 O-Ring: FPM
 Schutzart: IP 66 / IP 68
 Prüfnorm: IEC EN 60079-0 / IEC EN 60079-7 / IEC EN 60079-31
 Gas: II 2G Ex eb IIC Gb
 Staub: II 2D Ex tb IIIC Db
 Zone: Gas 1 und 2 / Staub 21 und 22
 Zertifikat: SEV 15 ATEX 0151
 IECEx Zertifikat: IECEx SEV 15.0018
 Einsatztemperatur: -60 °C / +100 °C

Material: Nickel-plated brass
 O-ring: FPM
 Protection class: IP 66 / IP 68
 Test standard: IEC EN 60079-0 / IEC EN 60079-7 / IEC EN 60079-31
 Gas: II 2G Ex eb IIC Gb
 Dust: II 2D Ex tb IIIC Db
 Zone: Gas 1 and 2 / dust 21 and 22
 Certificate: SEV 15 ATEX 0151
 IECEx Certificate: IECEx SEV 15.0018
 Operation temperature: -60 °C / +100 °C



Reduktion MS EX



Aussengewinde metrisch
 Innengewinde metrisch
 mit O-Ring

Outer thread metric
 Inner thread metric
 with O-ring

G	I	i info	 mm	H mm	L mm	i info	Art.-No.	
M10x1.5	M 8x1.25	1	13	8.0	5	2	EX3500.10.08	50
M12x1.5	M 8x1.25	1	15	3.0	5	2	EX3500.12.08	50
M12x1.5	M10x1.5	1	15	8.0	5	2	EX3500.12.10	50
M16x1.5	M10x1.5	1	18	3.0	5	-	EX3500.17.10	50
M16x1.5	M12x1.5	-	18	3.0	5	-	EX3500.17.12	50
M20x1.5	M12x1.5	-	24	3.0	6	-	EX3500.20.12	50
M20x1.5	M16x1.5	-	24	3.0	6	-	EX3500.20.17	50
M25x1.5	M16x1.5	-	30	3.5	7	-	EX3500.25.17	25
M25x1.5	M20x1.5	-	30	3.5	7	-	EX3500.25.20	25
M32x1.5	M20x1.5	-	36	4.0	8	-	EX3500.32.20	20
M32x1.5	M25x1.5	-	36	4.0	8	-	EX3500.32.25	20
M40x1.5	M25x1.5	-	46	4.5	8	-	EX3500.40.25	10
M40x1.5	M32x1.5	-	46	4.5	8	-	EX3500.40.32	10
M50x1.5	M32x1.5	-	55	5.0	9	-	EX3500.50.32	10
M50x1.5	M40x1.5	-	55	5.0	9	-	EX3500.50.40	10
M63x1.5	M40x1.5	-	70	5.5	10	-	EX3500.63.40	5
M63x1.5	M50x1.5	-	70	5.5	10	-	EX3500.63.50	5

1 = Metrisches Regelgewinde (mit VDE Testreport)

1 = Metric coarse-pitch thread (with VDE test report)

2 = Zertifikat SEV 15 ATEX 0152X / IECEx SEV 15.0019X

2 = Certificate SEV 15 ATEX 0152X / IECEx SEV 15.0019X

Das Ineinanderschrauben mehrerer Reduktionen/
 Erweiterungen ist nach Norm nicht zulässig!

The norm interdicts to screw several reduction/enlarging
 fittings into each other!

Reduktionen Messing erhöhte Sicherheit Ex e II

Reduction fittings nickel-plated brass increased safety Ex e II

Zubehör | Accessories

Material: Messing vernickelt
 O-Ring: FPM
 Schutzart: IP 66 / IP 68
 Prüfnorm: IEC EN 60079-0 /
 IEC EN 60079-7 /
 IEC EN 60079-31
 Gas: II 2G Ex eb IIC Gb
 Staub: II 2D Ex tb IIIC Db
 Zone: Gas 1 und 2 /
 Staub 21 und 22
 Zertifikat: SEV 15 ATEX 0151
 IECEx Zertifikat: IECEx SEV 15.0018
 Einsatztemperatur: -60 °C / +100 °C

Material: Nickel-plated brass
 O-ring: FPM
 Protection class: IP 66 / IP 68
 Test standard: IEC EN 60079-0 /
 IEC EN 60079-7 /
 IEC EN 60079-31
 Gas: II 2G Ex eb IIC Gb
 Dust: II 2D Ex tb IIIC Db
 Zone: Gas 1 and 2 /
 dust 21 and 22
 Certificate: SEV 15 ATEX 0151
 IECEx Certificate: IECEx SEV 15.0018
 Operation temperature: -60 °C / +100 °C

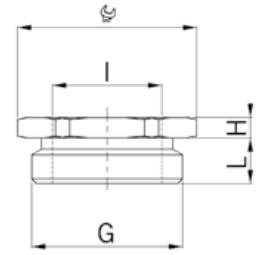

Aussengewinde Pg
 Innengewinde metrisch
 mit O-Ring

Outer thread Pg
 Inner thread metric
 with O-ring

G	I	i info	 mm	H mm	L mm	i info	Art.-No.	
Pg 7	M 8x1.25	1	15	3.0	6	2	EX3500.07.08	50
Pg 7	M10x1.5	1	15	7.0	6	2	EX3500.07.10	50
Pg 9	M 8x1.25	1	18	3.0	6	-	EX3500.09.08	50
Pg 9	M10x1.5	1	18	3.0	6	-	EX3500.09.10	50
Pg 9	M12x1.5	-	18	8.0	6	-	EX3500.09.12	50
Pg 11	M 8x1.25	1	21	3.0	6	-	EX3500.11.08	50
Pg 11	M10x1.5	1	21	3.0	6	-	EX3500.11.10	50
Pg 11	M12x1.5	-	21	3.0	6	-	EX3500.11.12	50
Pg 11	M16x1.5	-	21	8.0	6	-	EX3500.11.17	50
Pg 13	M12x1.5	-	24	3.0	6	-	EX3500.13.12	50
Pg 13	M16x1.5	-	24	3.0	6	-	EX3500.13.17	50
Pg 16	M12x1.5	-	24	3.0	6	-	EX3500.16.12	25
Pg 16	M16x1.5	-	24	3.0	6	-	EX3500.16.17	25
Pg 16	M20x1.5	-	24	10.5	6	-	EX3500.16.20	25
Pg 21	M16x1.5	-	30	3.5	7.5	-	EX3500.21.17	25
Pg 21	M20x1.5	-	30	3.5	7.5	-	EX3500.21.20	25
Pg 21	M25x1.5	-	30	10.5	7.5	-	EX3500.21.25	25
Pg 29	M25x1.5	-	38	4.0	8	-	EX3500.29.25	20
Pg 29	M32x1.5	-	38	13.0	8	-	EX3500.29.32	20
Pg 36	M32x1.5	-	50	4.5	8	-	EX3500.36.32	10
Pg 36	M40x1.5	-	50	4.5	8	-	EX3500.36.40	10
Pg 42	M32x1.5	-	55	5.0	10	-	EX3500.42.32	10
Pg 42	M40x1.5	-	55	5.0	10	-	EX3500.42.40	10
Pg 42	M50x1.5	-	55	15.0	10	-	EX3500.42.50	10
Pg 48	M40x1.5	-	65	5.5	11	-	EX3500.48.40	5
Pg 48	M50x1.5	-	65	5.5	11	-	EX3500.48.50	5



Reduktion MS EX



1 = Metrisches Regelgewinde (mit VDE Testreport)

1 = Metric coarse-pitch thread (with VDE test report)

2 = Zertifikat SEV 15 ATEX 0152X / IECEx SEV 15.0019X

2 = Certificate SEV 15 ATEX 0152X / IECEx SEV 15.0019X

Das Ineinanderschrauben mehrerer Reduktionen/
 Erweiterungen ist nach Norm nicht zulässig!

The norm interdicts to screw several reduction/enlarging
 fittings into each other!

Erweiterungen Messing erhöhte Sicherheit Ex e II

Enlarging fittings nickel-plated brass increased safety Ex e II

Zubehör | Accessories

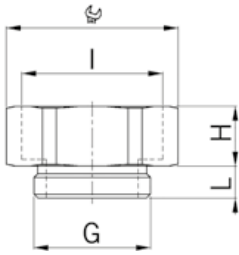

Material: Messing vernickelt
 O-Ring: FPM
 Schutzart: IP 66 / IP 68
 Prüfnorm: IEC EN 60079-0 / IEC EN 60079-7 / IEC EN 60079-31
 Gas: II 2G Ex eb IIC Gb
 Staub: II 2D Ex tb IIIC Db
 Zone: Gas 1 und 2 / Staub 21 und 22
 Zertifikat: SEV 15 ATEX 0151
 IECEx Zertifikat: IECEx SEV 15.0018
 Einsatztemperatur: -60 °C / +100 °C

Material: Nickel-plated brass
 O-ring: FPM
 Protection class: IP 66 / IP 68
 Test standard: IEC EN 60079-0 / IEC EN 60079-7 / IEC EN 60079-31
 Gas: II 2G Ex eb IIC Gb
 Dust: II 2D Ex tb IIIC Db
 Zone: Gas 1 and 2 / dust 21 and 22
 Certificate: SEV 15 ATEX 0151
 IECEx Certificate: IECEx SEV 15.0018
 Operation temperature: -60 °C / +100 °C



Erweiterung MS EX



Aussengewinde metrisch
 Innengewinde metrisch
 mit O-Ring

Outer thread metric
 Inner thread metric
 with O-ring

G	I	i info	mm	H mm	L mm	i info	Art.-No.	
M 8x1.25	M10x1.5	1	13	9	5	2	EX3600.08.10	50
M10x1.5	M12x1.5	1	15	9	5	2	EX3600.10.12	50
M12x1.5	M16x1.5	-	18	9	5	2	EX3600.12.17	50
M16x1.5	M20x1.5	-	24	10	5	-	EX3600.17.20	50
M20x1.5	M25x1.5	-	30	11.5	6	-	EX3600.20.25	25
M25x1.5	M32x1.5	-	36	14	7	-	EX3600.25.32	25
M32x1.5	M40x1.5	-	46	14	8	-	EX3600.32.40	25
M40x1.5	M50x1.5	-	55	16	8	-	EX3600.40.50	10
M50x1.5	M63x1.5	-	70	17	9	-	EX3600.50.63	10

1 = Metrisches Regelgewinde (mit VDE Testreport)

1 = Metric coarse-pitch thread (with VDE test report)

2 = Zertifikat SEV 15 ATEX 0152X / IECEx SEV 15.0019X

2 = Certificate SEV 15 ATEX 0152X / IECEx SEV 15.0019X

Das Ineinanderschrauben mehrerer Reduktionen/-Erweiterungen ist nach Norm nicht zulässig!

The norm interdicts to screw several reduction/enlarging fittings into each other!

Erweiterungen Messing erhöhte Sicherheit Ex e II

Enlarging fittings nickel-plated brass increased safety Ex e II

Zubehör | Accessories

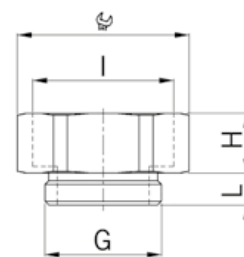

Material: Messing vernickelt
 O-Ring: FPM
 Schutzart: IP 66 / IP 68
 Prüfnorm: IEC EN 60079-0 /
 IEC EN 60079-7 /
 IEC EN 60079-31
 Gas: II 2G Ex eb IIC Gb
 Staub: II 2D Ex tb IIIC Db
 Zone: Gas 1 und 2 /
 Staub 21 und 22
 Zertifikat: SEV 15 ATEX 0151
 IECEx Zertifikat: IECEx SEV 15.0018
 Einsatztemperatur: -60 °C / +100 °C

Material: Nickel-plated brass
 O-ring: FPM
 Protection class: IP 66 / IP 68
 Test standard: IEC EN 60079-0 /
 IEC EN 60079-7 /
 IEC EN 60079-31
 Gas: II 2G Ex eb IIC Gb
 Dust: II 2D Ex tb IIIC Db
 Zone: Gas 1 and 2 /
 dust 21 and 22
 Certificate: SEV 15 ATEX 0151
 IECEx Certificate: IECEx SEV 15.0018
 Operation temperature: -60 °C / +100 °C



Aussengewinde Pg
 Innengewinde metrisch
 mit O-Ring

Outer thread Pg
 Inner thread metric
 with O-ring

G	I	 mm	H mm	L mm	i info	Art.-No.	
Pg 7	M12x1.5	15	9.0	6	2	EX3600.07.12	50
Pg 7	M16x1.5	18	9.0	6	2	EX3600.07.17	50
Pg 9	M16x1.5	18	9.5	6	-	EX3600.09.17	50
Pg 9	M20x1.5	24	10.5	6	-	EX3600.09.20	50
Pg 11	M20x1.5	24	10.5	6	-	EX3600.11.20	50
Pg 11	M25x1.5	30	11.5	6	-	EX3600.11.25	25
Pg 13	M20x1.5	24	10.5	6	-	EX3600.13.20	50
Pg 13	M25x1.5	30	11.5	6	-	EX3600.13.25	25
Pg 16	M25x1.5	30	11.5	6	-	EX3600.16.25	25
Pg 16	M32x1.5	36	13.5	6	-	EX3600.16.32	25
Pg 21	M32x1.5	36	14.0	7.5	-	EX3600.21.32	25
Pg 21	M40x1.5	46	14.0	7.5	-	EX3600.21.40	20
Pg 29	M40x1.5	46	14.0	8	-	EX3600.29.40	20
Pg 29	M50x1.5	55	16.0	8	-	EX3600.29.50	10
Pg 36	M50x1.5	55	16.0	8	-	EX3600.36.50	10
Pg 36	M63x1.5	70	17.0	8	-	EX3600.36.63	10
Pg 42	M63x1.5	70	17.0	10	-	EX3600.42.63	10
Pg 48	M63x1.5	70	17.0	11	-	EX3600.48.63	10

2 = Zertifikat SEV 15 ATEX 0152X / IECEx SEV 15.0019X 2 = Certificate SEV 15 ATEX 0152X / IECEx SEV 15.0019X

Das Ineinanderschrauben mehrerer Reduktionen/
 Erweiterungen ist nach Norm nicht zulässig!

The norm interdicts to screw several reduction/enlarging
 fittings into each other!



Erweiterung MS EX



Verschlusschrauben Messing erhöhte Sicherheit Ex e II

Locking plugs nickel-plated brass increased safety Ex e II

Kurzes Anschlussgewinde metrisch | Short entry thread metric

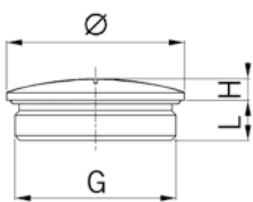

Material: Messing vernickelt
 O-Ring: FPM
 Schutzart: IP 66 / IP 68
 Prüfnorm: IEC EN 60079-0 / IEC EN 60079-7 / IEC EN 60079-31
 Gas: II 2G Ex eb IIC Gb
 Staub: II 2D Ex tb IIIC Db
 Zone: Gas 1 und 2 / Staub 21 und 22
 Zertifikat: SEV 15 ATEX 0151
 IECEx Zertifikat: IECEx SEV 15.0018
 Einsatztemperatur: -60 °C / +100 °C

Material: Nickel-plated brass
 O-ring: FPM
 Protection class: IP 66 / IP 68
 Test standard: IEC EN 60079-0 / IEC EN 60079-7 / IEC EN 60079-31
 Gas: II 2G Ex eb IIC Gb
 Dust: II 2D Ex tb IIIC Db
 Zone: Gas 1 and 2 / dust 21 and 22
 Certificate: SEV 15 ATEX 0151
 IECEx Certificate: IECEx SEV 15.0018
 Operation temperature: -60 °C / +100 °C



Verschlusszapfen
MS EX



mit O-Ring

G	Ø mm	H mm	L mm	i info
M8x1.25	10	3	5	1
M10x1.5	12	3	5	1
M12x1.5	14	3	5	-
M16x1.5	19	3	5	-
M20x1.5	24	3	6	-
M25x1.5	28	4	7	-
M32x1.5	35	4	8	-
M40x1.5	45	6	8	-
M50x1.5	55	6	9	-
M63x1.5	70	6	10	-

1 = Metrisches Regelgewinde (mit VDE Testreport)

Auf Anfrage lieferbar:

Langes Anschlussgewinde

Ausführungen in Stahl A2 und A4

with O-ring

Art.-No.



EX8708.08	50
EX8710.08	50
EX8712.08	50
EX8717.08	50
EX8720.08	25
EX8725.08	25
EX8732.08	10
EX8740.08	10
EX8750.08	10
EX8763.08	10

1 = Metric coarse-pitch thread (with VDE test report)

Available on request:

Long entry thread

Executions in steel A2 and A4

Kurzes Anschlussgewinde Pg | Short entry thread Pg



Verschlusszapfen
MS EX



mit O-Ring

G	Ø mm	H mm	L mm
Pg 7	14	3	5
Pg 9	17	3	6
Pg 11	20	3	6
Pg 13	22	3	6.5
Pg 16	24	3	6.5
Pg 21	30	4	7
Pg 29	39	4	8
Pg 36	50	6	9
Pg 48	65	6	10

Auf Anfrage lieferbar:

Langes Anschlussgewinde

Ausführungen in Stahl A2 und A4

with O-ring

Art.-No.



EX8707.08	50
EX8709.08	50
EX8711.08	50
EX8713.08	50
EX8716.08	50
EX8721.08	10
EX8729.08	10
EX8736.08	10
EX8748.08	10

Available on request:

Long entry thread

Executions in steel A2 and A4



Verschlusschrauben Kunststoff erhöhte Sicherheit Ex e II

Synthetic locking plugs for increased safety Ex e II

Anschlussgewinde metrisch | Entry thread metric

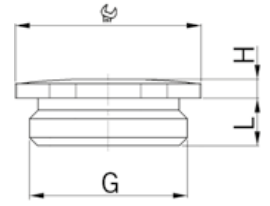

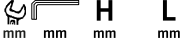
Material:	Polyamid glasfaserverstärkt	Material:	Polyamide glass fiber reinforced
O-Ring:	NBR	O-ring:	NBR
Schutzart:	IP 68 (bis 10 bar) / IP 69	Protection class:	IP 68 (up to 10 bar) / IP 69
Prüfnorm:	IEC EN 60079-0 / IEC EN 60079-7 / IEC EN 60079-31	Test standard:	IEC EN 60079-0 / IEC EN 60079-7 / IEC EN 60079-31
Gas:	II 2G Ex e IIC Gb	Gas:	II 2G Ex e IIC Gb
Staub:	II 1D Ex ta IIIC Ga	Dust:	II 1D Ex ta IIIC Ga
Zone:	Gas 2 / Staub 21	Zone:	Gas 2 / dust 21
Zertifikat:	DMT 03 ATEX E 049	Certificate:	DMT 03 ATEX E 049
IECEX Zertifikat:	IECEX BVS 07.0021	IECEX Certificate:	IECEX BVS 07.0021
Einsatztemperatur:	-20 °C / +90 °C	Operation temperature:	-20 °C / +90 °C



Schwarz RAL 9005 mit O-Ring	Black RAL 9005 with O-ring		
G		H	L
	mm mm	mm	mm
M12x1.5	15 6	13.0	8.5
M16x1.5	19 8	13.0	8.5
M20x1.5	24 8	14.5	9.0
M25x1.5	28 8	16.0	10.5
M32x1.5	36 8	17.5	11.5
M40x1.5	46 8	18.0	11.5
M50x1.5	55 8	20.0	13.5
M63x1.5	70 8	21.0	14.5
			Art.-No.
			
			8841.12 100
			8841.17 100
			8841.20 100
			8841.25 100
			8841.32 100
			8841.40 50
			8841.50 25
			8841.63 10



Anschlussgewinde Pg | Entry thread Pg

Schwarz RAL 9005 mit O-Ring	Black RAL 9005 with O-ring		
G		H	L
	mm mm	mm	mm
Pg 7	15 6	13.0	8.5
Pg 9	19 8	13.0	8.5
Pg 11	24 8	14.5	9.0
Pg 13	24 8	14.5	9.0
Pg 16	28 8	16.0	10.5
Pg 21	36 8	17.5	11.5
Pg 29	46 8	18.0	11.5
Pg 36	55 8	20.0	13.5
Pg 42	60 8	20.0	13.5
Pg 48	70 8	21.0	14.5
			Art.-No.
			
			8841.07 100
			8841.09 100
			8841.11 100
			8841.13 100
			8841.16 100
			8841.21 100
			8841.29 50
			8841.36 25
			8841.42 10
			8841.48 10



Kabelverschraubungen Progress® AgreenO Messing bleifrei Progress® AgreenO cable glands of lead-free brass



Die **Progress® AgreenO** Produkte von AGRO verwenden ein Material mit der Werkstoffbezeichnung CuZn21Si3P mit einem maximalen Bleigehalt von 0,1%. Nachhaltigkeit und Qualität ist ein wichtiger Baustein für die Zukunft. Anwender dieser nachhaltigen und zukunftsorientierten Produktalternative müssen dabei keinerlei Abstriche in Bezug auf Performance, Qualität oder Festigkeit hinnehmen. Das gilt sowohl für alle mechanischen Eigenschaften und die Korrosionsbeständigkeit als auch für die EMV-Eigenschaften.

Der Wahl von CuZn21Si3P bleifrei als Material für das **Progress® AgreenO** Sortiment ging ein strenges mehrmonatiges Evaluationsverfahren voraus. Die Wahl des Materials wurde durch zahlreiche Tests im AGRO-Prüflabor bestätigt. Selbstverständlich erfüllen auch diese Produkte die IEC EN 62444 und UL 514B sowie die Schutzarten IP 68 / IP 69.

AGRO's **Progress® AgreenO** products use the material CuZn21Si3P with a maximum lead content of 0.1%. Sustainability and quality are together an important foundation element for the future. Of course, users of these sustainable and future-oriented products do not have to accept any compromises in terms of performance, quality or reliability. This applies not only in relation to all mechanical properties and corrosion resistance, but also to the products' EMC properties.





The choice of lead-free CuZn21Si3P as material for the **Progress® AgreenO** range was preceded by a rigorous evaluation process that lasted several months. The suitability of the material was confirmed by numerous tests in the AGRO testing laboratory. Of course, these products also comply with IEC EN 62444 and UL 514B, and meet the demands of protection classes IP 68 / IP 69.



Die Artikelnummern für die bleifreien Kabelverschraubungen **Progress® AgreenO** werden mit dem Zusatz „LF“ (Lead Free) ergänzt. Das Produkt selbst ist mit einer Kerbe an der Druckmutter und dem Unterteil gekennzeichnet. Dadurch ist die sichere Identifizierung jederzeit sichergestellt.

The part numbers of lead-free **Progress® AgreenO** cable glands include the letters "LF" at the end of the part number. The product itself is marked with a groove on the compression nut as well as on the lower part, ensuring reliable identification at all times.



Kabelverschraubungen Progress® AgreenO Messing bleifrei Cable glands Progress® AgreenO nickel-plated brass lead-free	 190 - 191	1
Kabelverschraubungen Progress® AgreenO EMV easyCONNECT Messing bleifrei mit Kontaktfeder Cable glands Progress® AgreenO EMC easyCONNECT nickel-plated brass lead-free with contact spring	 192	2
Kabelverschraubungen Progress® AgreenO EMV Messing bleifrei mit Kontakthülse Cable glands Progress® AgreenO EMC nickel-plated brass lead-free with contact sleeve	 193 - 194	3
EMV-Gegenmuttern AgreenO Messing bleifrei mit Schneidezähnen Lock nuts AgreenO nickel-plated brass lead-free with cutting teeth	 195	4

1

2

3

4

5

6

7

8

9

10

11

12

13

14

15

Kabelverschraubungen Progress® AgreenO Messing bleifrei

Progress® AgreenO cable glands of lead-free brass

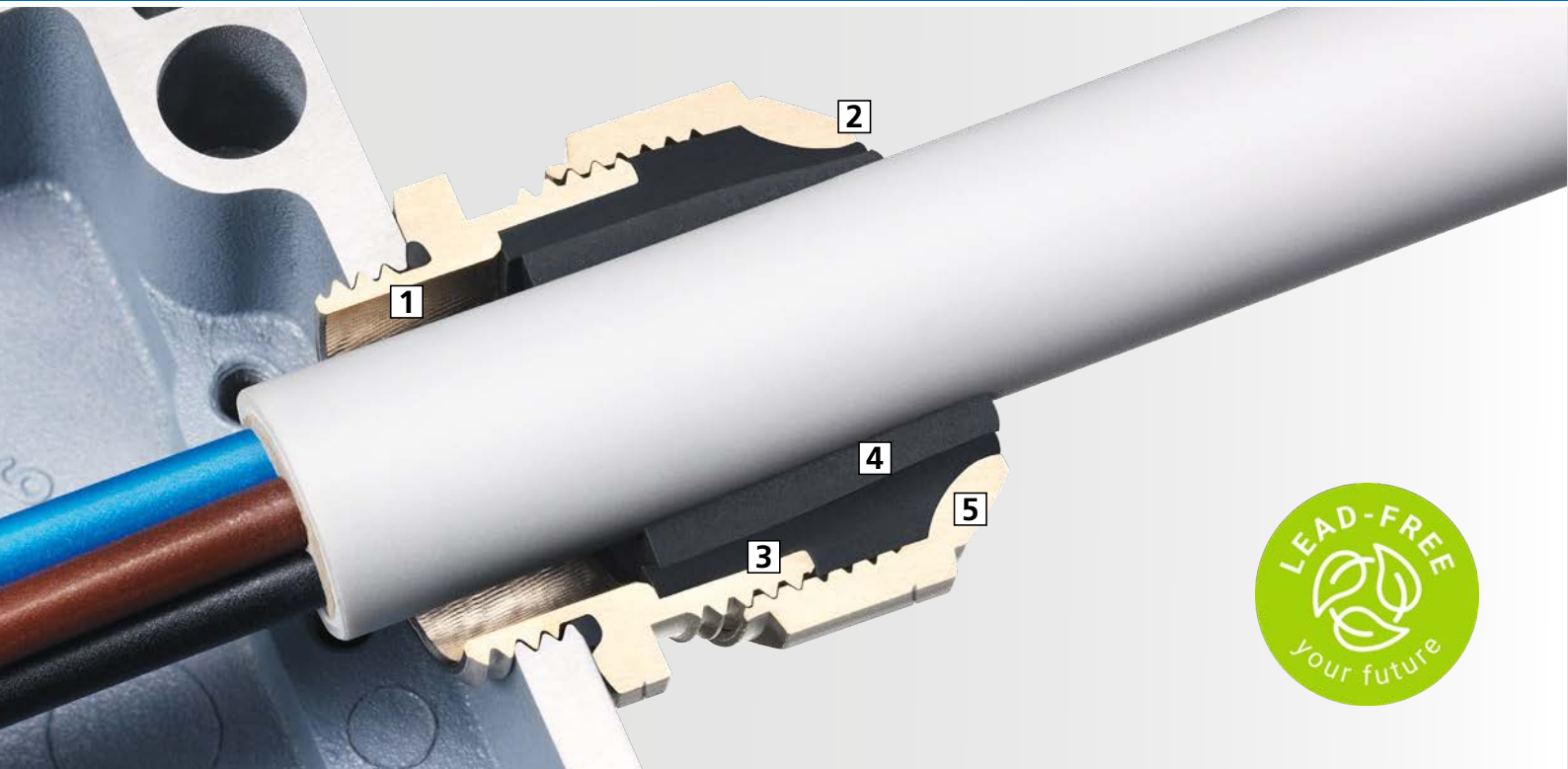

AGRO Kabelverschraubungen Progress® AgreenO Messing bleifrei sind bewährte Helfer für die fachgerechte Kabeleinführung in Industrieanlagen. Durch die richtige Wahl mit dem passenden Dichteinsatz sind sie überall einsetzbar. Die herausragende Kompressionstechnik sorgt für eine hohe Dichtigkeit und eine äußerst kabelschonende Zugentlastung auch bei dynamischen Belastungen.

1 Kurze, lange oder Spezial-Anschlussgewinde

Kabelverschraubungen **Progress® AgreenO** mit kurzem oder langem Anschlussgewinde in metrischer Ausführung, Ausführungen mit Pg- oder NPT-Anschlussgewinde sind auf Anfrage lieferbar. Die Anschlussgewinde können direkt ins Gehäuse geschraubt werden oder können bei vorhandenen Bohrungen mit Gegenmutter verwendet werden.

2 Sichtbare Sicherheit

Der kleine Wulst des Dichteinsatzes bestätigt das richtige Anzugsdrehmoment oder verwenden Sie für das richtige Drehmoment unsere Montagendrehmoment-Tabelle im Internet unter www.agro.ch.

3 Hoher Verdrehenschutz

Die im Unterteil integrierte Längsrandrierung sorgt über den Dichteinsatz für eine hohe Verdrehsicherheit und verhindert so das Mitdrehen des Kabels.

4 Grosse Flexibilität

Zweiteilige Dichteinsätze können in Sekundenschnelle vor Ort auf den vorhandenen Kabeldurchmesser angepasst werden.

5 Garantierte Dichtigkeit

Auf den Dichteinsatz abgestimmte Innenkonturen sorgen für eine zielgerichtete Verformung des Dichteinsatzes und garantieren somit dessen perfekte Abdichtung. Die Schutzart IP 68 bis 10 bar sowie IP 69 ermöglichen eine breite Anwendung.

AGRO Progress® AgreenO cable glands of lead-free brass are tried-and-trusted cable entry solutions for professional cabling work in industrial facilities. With the right selection and the right sealing insert, they can be used anywhere. The cable gland's outstanding compression technology ensures a high degree of leak-tightness and extremely cable-friendly strain relief, even if subjected to dynamic loading.

1 Short, Long or Special entry threads

Progress® AgreenO cable glands with short or long connection threads in metric design as standard; versions with PG or NPT entry threads are available on request. The entry thread can be screwed directly into the housing, or the cable gland can alternatively be installed with a lock nut where a suitable hole exists.

2 Visible reliability

A slight bulging of the sealing insert indicates the correct tightening torque during installation, or refer to the appropriate torque table on our website, www.agro.ch.

3 Good anti-rotation protection

The longitudinal knurling (surface texture) applied to the cable gland's lower part provides a high degree of protection against cable rotation, via the sealing insert.

4 Great flexibility

Two-part sealing inserts can be adapted on site in a matter of seconds to suit the existing cable diameter.

5 Reliable leak-tightness

Inner contours that precisely suit the shape of the sealing insert ensure optimal deformation of the sealing insert and thus perfect sealing. Protection classes IP 68 (up to 10 bar) and IP 69 facilitate a wide range of applications.



Progress® AgreenO EMV easyCONNECT Messing bleifrei

Die Kabelverschraubung gewährleistet volle Installationskontrolle und gleicht Toleranzen in den Schirmdicken für einen sicheren Schirmabgriff aus. Das Federsystem ermöglicht eine gute und sichere Schirmkontaktierung sowohl bei partiell abisolierten Abschirmkabeln als auch bei vollständig freigelegten Kabelschirmen.

1 Optimale Schirmkontaktierung

Die kraftvolle, schonende Klemmung des Kabelschirms garantiert einen hervorragenden Schirmkontakt und sorgt für extrem niedrige Transferimpedanzen. Durch die spezielle Formgebung der Kontaktfeder ist nicht nur ein grosser Schirmklemmbereich sondern auch die Demontierbarkeit der Kabelverschraubung ohne Zerstörung des EMV-Geflechtes gegeben.

Progress® AgreenO EMC easyCONNECT of lead-free brass

This cable gland provides full installation control and compensates for tolerances in shielding thickness to ensure reliable shield grip. The spring system facilitates good and reliable shield contact for either partially stripped shielded cables or fully exposed cable shields.

1 Optimal shield contact

The strong yet gentle clamping of the cable shield ensures excellent shield contact and extremely low transfer impedances. The special shape of the contact spring results in a wide shield clamping range, and also enables the cable gland to be dismantled without destroying the EMC braiding.

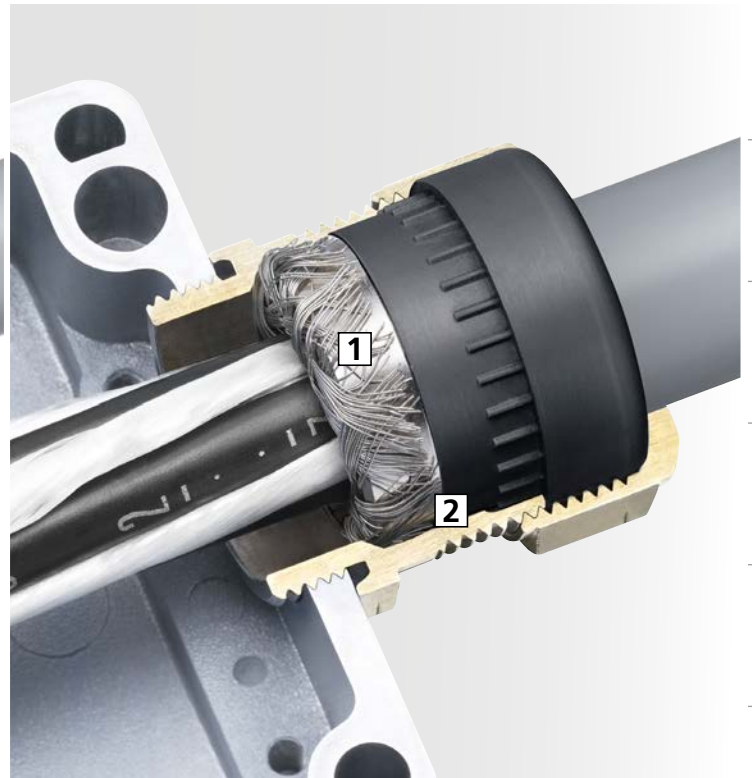

Progress® AgreenO EMV Messing bleifrei

Die Kabelverschraubungen mit der bewährten Kontakthülse ermöglichen eine Schirmkontaktierung von 360° bei in der Kabelverschraubung endendem Schirmgeflecht. Die massgebende Kanten geometrie der Kontakthülse verhindert hierbei ein Abscheren des Schirmgeflechtes.

1 Kleinste Übergangswiderstände

Der konzentrische Schirmabgriff von 360° bürgt für kleinste Übergangswiderstände.

2 Permanenter Kontaktdruck

Die ineinandergreifende Kombination „Dichteinsatz-Kontakthülse“ garantiert einen permanenten Kontaktdruck des Schirmgeflechtes am Unterteil.

Progress® AgreenO EMC of lead-free brass

This cable gland with its tried-and-tested contact sleeve facilitates 360° shield contact with the shield braiding ending in the cable gland. The geometry of the contact sleeve's edge prevents the shield braiding from shearing off.

1 Very low contact resistance

The concentric 360° shield grip minimises contact resistance.

2 Permanent contact pressure

The interlocking combination “sealing insert – contact sleeve” ensures permanent contact pressure of the shield braiding on the cable gland's lower part.

Kabelverschraubungen Progress® AgreenO Messing bleifrei

Cable glands Progress® AgreenO nickel-plated brass lead-free

Kurzes Anschlussgewinde metrisch | Short entry thread metric

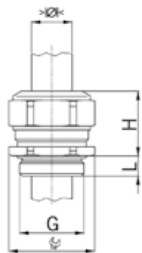

Material: Messing CuZn21Si3P bleifrei
 Oberfläche: Vernickelt
 Dichtung: TPE
 O-Ring: NBR
 Zugentlastung: Ausführung A nach EN 62444
 Schutzart: IP 68 (bis 10 bar) / IP 69
 Einsatztemperatur: -40 °C / +100 °C

Material: Brass CuZn21Si3P lead-free
 Surface: Nickel-plated
 Seal: TPE
 O-ring: NBR
 Strain relief: Version A acc. to EN 62444
 Protection class: IP 68 (up to 10 bar) / IP 69
 Operation temperature: -40 °C / +100 °C



Einteiliger Dichteinsatz
nicht durchgehend isolierend

One-piece sealing insert
not overall length insulated

G	>Ø< min mm	>Ø< max mm	mm	H mm	L mm	Art.-No.	
M12x1.5	3.5	5.0	15	17	5	1000.12.050LF	50
M12x1.5	5.0	6.5	15	17	5	1000.12.065LF	50
M12x1.5	6.5	8.0	15	17	5	1000.12.080LF	50
M16x1.5	3.5	4.5	18	20	5	1000.17.045LF	50
M16x1.5	4.5	6.0	18	20	5	1000.17.060LF	50
M16x1.5	6.0	8.0	18	20	5	1000.17.080LF	50
M16x1.5	8.0	10.5	18	22	5	1000.17.105LF	50
M20x1.5	6.0	8.0	24	21	6	1000.20.080LF	50
M20x1.5	8.0	11.0	24	21	6	1000.20.110LF	50
M20x1.5	11.0	15.0	24	23	6	1000.20.150LF	50
M25x1.5	9.5	12.5	30	25	7	1000.25.125LF	25
M25x1.5	12.5	16.0	30	27	7	1000.25.160LF	25
M25x1.5	16.0	20.5	30	28	7	1000.25.205LF	25
M32x1.5	14.0	17.0	36	28	8	1000.32.170LF	25
M32x1.5	17.0	21.0	36	28	8	1000.32.210LF	25
M32x1.5	21.0	25.5	36	28	8	1000.32.255LF	25
M40x1.5	20.0	24.0	46	31	8	1000.40.240LF	10
M40x1.5	24.0	28.5	46	31	8	1000.40.285LF	10
M40x1.5	28.5	33.0	46	31	8	1000.40.330LF	10
M50x1.5	29.0	33.0	55	34	9	1000.50.330LF	10
M50x1.5	33.0	37.0	55	34	9	1000.50.370LF	10
M50x1.5	37.0	42.0	55	34	9	1000.50.420LF	10
M63x1.5	35.0	40.0	70	37	10	1000.63.400LF	5
M63x1.5	40.0	46.0	70	37	10	1000.63.460LF	5
M63x1.5	46.0	52.0	70	37	10	1000.63.520LF	5

Auf Anfrage lieferbar:
Anschlussgewinde Pg und NPT

Available on request:
Entry thread Pg and NPT



Zweiteiliger Dichteinsatz
nicht durchgehend isolierend

Two-piece sealing insert
not overall length insulated

G	>Ø< min mm	>Ø< max mm	>Ø< min mm	>Ø< max mm	mm	H mm	L mm	Art.-No.	
M16x1.5	6.0	8.0	8.0	10.5	18	22	5	1000.17LF	50
M20x1.5	8.0	11.0	11.0	15.0	24	23	6	1000.20LF	50
M25x1.5	12.5	16.0	16.0	20.5	30	28	7	1000.25LF	25
M32x1.5	17.0	21.0	21.0	25.5	36	28	8	1000.32LF	25
M40x1.5	24.0	28.5	28.5	33.0	46	31	8	1000.40LF	10
M50x1.5	33.0	37.0	37.0	42.0	55	34	9	1000.50LF	10
M63x1.5	40.0	46.0	46.0	52.0	70	37	10	1000.63LF	5

Auf Anfrage lieferbar:
Anschlussgewinde Pg und NPT

Available on request:
Entry thread Pg and NPT

Kabelverschraubungen Progress® AgreenO Messing bleifrei

Cable glands Progress® AgreenO nickel-plated brass lead-free

Langes Anschlussgewinde metrisch | Long entry thread metric

Material:	Messing CuZn21Si3P bleifrei	Material:	Brass CuZn21Si3P lead-free
Oberfläche:	Vernickelt	Surface:	Nickel-plated
Dichtung:	TPE	Seal:	TPE
O-Ring:	NBR	O-ring:	NBR
Zugentlastung:	Ausführung A nach EN 62444	Strain relief:	Version A acc. to EN 62444
Schutzart:	IP 68 (bis 10 bar) / IP 69	Protection class:	IP 68 (up to 10 bar) / IP 69
Einsatztemperatur:	-40 °C / +100 °C	Operation temperature:	-40 °C / +100 °C

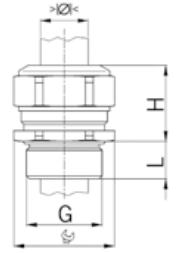

Einteiliger Dichteinsatz
nicht durchgehend isolierend

One-piece sealing insert
not overall length insulated

G	>Ø< min mm	>Ø< max mm	Ø mm	H mm	L mm	Art.-No.	
M12x1.5	3.5	5.0	15	17	10	1100.12.050LF	50
M12x1.5	5.0	6.5	15	17	10	1100.12.065LF	50
M12x1.5	6.5	8.0	15	17	10	1100.12.080LF	50
M16x1.5	3.5	4.5	18	20	10	1100.17.045LF	50
M16x1.5	4.5	6.0	18	20	10	1100.17.060LF	50
M16x1.5	6.0	8.0	18	20	10	1100.17.080LF	50
M16x1.5	8.0	10.5	18	22	10	1100.17.105LF	50
M20x1.5	6.0	8.0	24	21	10	1100.20.080LF	50
M20x1.5	8.0	11.0	24	21	10	1100.20.110LF	50
M20x1.5	11.0	15.0	24	23	10	1100.20.150LF	50
M25x1.5	9.5	12.5	30	25	11	1100.25.125LF	25
M25x1.5	12.5	16.0	30	27	11	1100.25.160LF	25
M25x1.5	16.0	20.5	30	28	11	1100.25.205LF	25
M32x1.5	14.0	17.0	36	28	13	1100.32.170LF	25
M32x1.5	17.0	21.0	36	28	13	1100.32.210LF	25
M32x1.5	21.0	25.5	36	28	13	1100.32.255LF	25
M40x1.5	20.0	24.0	46	31	13	1100.40.240LF	10
M40x1.5	24.0	28.5	46	31	13	1100.40.285LF	10
M40x1.5	28.5	33.0	46	31	13	1100.40.330LF	10
M50x1.5	29.0	33.0	55	34	14	1100.50.330LF	10
M50x1.5	33.0	37.0	55	34	14	1100.50.370LF	10
M50x1.5	37.0	42.0	55	34	14	1100.50.420LF	10
M63x1.5	35.0	40.0	70	37	14	1100.63.400LF	5
M63x1.5	40.0	46.0	70	37	14	1100.63.460LF	5
M63x1.5	46.0	52.0	70	37	14	1100.63.520LF	5

Auf Anfrage lieferbar:
Anschlussgewinde Pg und NPT

Available on request:
Entry thread Pg and NPT



Zweiteiliger Dichteinsatz
nicht durchgehend isolierend

Two-piece sealing insert
not overall length insulated

G	>Ø< min mm	>Ø< max mm	>Ø< min mm	>Ø< max mm	Ø mm	H mm	L mm	Art.-No.	
M16x1.5	6.0	8.0	8.0	10.5	18	22	10	1100.17LF	50
M20x1.5	8.0	11.0	11.0	15.0	24	23	10	1100.20LF	50
M25x1.5	12.5	16.0	16.0	20.5	30	28	11	1100.25LF	25
M32x1.5	17.0	21.0	21.0	25.5	36	28	13	1100.32LF	25
M40x1.5	24.0	28.5	28.5	33.0	46	31	13	1100.40LF	10
M50x1.5	33.0	37.0	37.0	42.0	55	34	14	1100.50LF	10
M63x1.5	40.0	46.0	46.0	52.0	70	37	14	1100.63LF	5

Auf Anfrage lieferbar:
Anschlussgewinde Pg und NPT

Available on request:
Entry thread Pg and NPT



Kurzes Anschlussgewinde metrisch | Short entry thread metric

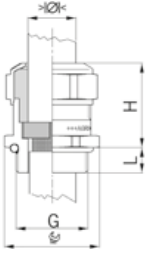

Material: Messing CuZn21Si3P bleifrei
 Oberfläche: Vernickelt
 Kontaktfeder: Federstahl 1.4310
 Dichtung: TPE
 O-Ring: NBR
 Zugentlastung: Ausführung A nach EN 62444
 Schutzart: IP 68 (bis 10 bar) / IP 69
 Eigenschaften: Für zeitsparende und sichere Montage von partiell abisolierten sowie durchgehend geschirmten Kabeln
 Einsatztemperatur: -60 °C / +100 °C

Material: Brass CuZn21Si3P lead-free
 Surface: Nickel-plated
 Contact spring: Spring steel 1.4310
 Seal: TPE
 O-ring: NBR
 Strain relief: Version A acc. to EN 62444
 Protection class: IP 68 (up to 10 bar) / IP 69
 Properties: For a quick and safe installation of partially dismantled cables as well as thoroughly shielded cables
 Operation temperature: -60 °C / +100 °C



Progress AgreenO
EMV easyCONNECT



Zweiteiliger Dichteinsatz
nicht durchgehend isolierend

Two-piece sealing insert
not overall length insulated

G	> Ø <	> Ø <	> Ø <	> Ø <	mm	H	L	i	Art.-No.	
	min mm	max mm	min mm	max mm	mm	mm	mm	info		
M12x1.5	-	-	5.0	6.5	15	22	5	1	1083.12.050LF	50
M12x1.5	-	-	5.0	6.5	15	22	5	1	1083.12.065LF	50
M16x1.5	6.0	8.0	8.0	10.5	18	25	5	-	1083.17LF	50
M20x1.5	8.0	11.0	11.0	15.0	24	27	6	-	1083.20LF	50
M25x1.5	12.5	16.0	16.0	20.5	30	33	7	-	1083.25LF	25
M32x1.5	17.0	21.0	21.0	25.5	36	33	8	-	1083.32LF	25
M40x1.5	24.0	28.5	28.5	33.0	46	38	8	-	1083.40LF	10
M50x1.5	33.0	37.0	37.0	42.0	55	42	9	-	1083.50LF	10
M63x1.5	40.0	46.0	46.0	52.0	70	42	10	-	1083.63LF	5

1 = Einteiliger Dichteinsatz
 Auf Anfrage lieferbar:
 Anschlussgewinde Pg und NPT

1 = One-piece sealing insert
 Available on request:
 Entry thread Pg and NPT

Langes Anschlussgewinde metrisch | Long entry thread metric



Progress AgreenO
EMV easyCONNECT



Zweiteiliger Dichteinsatz
nicht durchgehend isolierend

Two-piece sealing insert
not overall length insulated

G	> Ø <	> Ø <	> Ø <	> Ø <	mm	H	L	i	Art.-No.	
	min mm	max mm	min mm	max mm	mm	mm	mm	info		
M12x1.5	-	-	3.5	5.0	15	22	10	1	1183.12.050LF	50
M12x1.5	-	-	5.0	6.5	15	22	10	1	1183.12.065LF	50
M16x1.5	6.0	8.0	8.0	10.5	18	25	10	-	1183.17LF	50
M20x1.5	8.0	11.0	11.0	15.0	24	27	10	-	1183.20LF	50
M25x1.5	12.5	16.0	16.0	20.5	30	33	11	-	1183.25LF	25
M32x1.5	17.0	21.0	21.0	25.5	36	33	13	-	1183.32LF	25
M40x1.5	24.0	28.5	28.5	33.0	46	38	13	-	1183.40LF	10
M50x1.5	33.0	37.0	37.0	42.0	55	42	14	-	1183.50LF	10
M63x1.5	40.0	46.0	46.0	52.0	70	42	14	-	1183.63LF	5

1 = Einteiliger Dichteinsatz
 Auf Anfrage lieferbar:
 Anschlussgewinde Pg und NPT

1 = One-piece sealing insert
 Available on request:
 Entry thread Pg and NPT

Kabelverschraubungen Progress® AgreenO EMV Messing bleifrei mit Kontakthülse

Cable glands Progress® AgreenO EMC nickel-plated brass lead-free with contact sleeve

Kurzes Anschlussgewinde metrisch | Short entry thread metric

Material:	Messing CuZn21Si3P bleifrei	Material:	Brass CuZn21Si3P lead-free
Oberfläche:	Vernickelt	Surface:	Nickel-plated
Kontakthülse:	Messing CuZn21Si3P bleifrei	Contact sleeve:	Brass CuZn21Si3P lead-free
Dichtung:	TPE	Seal:	TPE
O-Ring:	NBR	O-ring:	NBR
Zugentlastung:	Ausführung A nach EN 62444	Strain relief:	Version A acc. to EN 62444
Schutzart:	IP 68 (bis 10 bar) / IP 69	Protection class:	IP 68 (up to 10 bar) / IP 69
Eigenschaften:	Sehr guter Schirmkontakt über die Kontakthülse bei in der Kabelverschraubung endendem Schirmgeflecht	Properties:	Excellent shield contact through the contact sleeve with the braided shield terminating in the screwed cable gland
Einsatztemperatur:	-40 °C / +100 °C	Operation temperature:	-40 °C / +100 °C

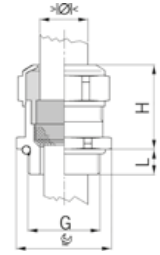

Einteiliger Dichteinsatz nicht durchgehend isolierend		One-piece sealing insert not overall length insulated				
G	>Ø< min mm	>Ø< max mm	H mm	L mm	Art.-No.	
M12x1.5	4.5	6.0	15	20	1080.12.060LF	50
M12x1.5	6.0	7.5	15	20	1080.12.075LF	50
M16x1.5	6.0	8.0	18	23	1080.17.080LF	50
M16x1.5	8.0	10.0	18	25	1080.17.100LF	50
M20x1.5	8.0	11.0	24	25	1080.20.110LF	50
M20x1.5	11.0	14.0	24	27	1080.20.140LF	50
M25x1.5	13.0	16.0	30	30	1080.25.160LF	25
M25x1.5	16.0	19.0	30	33	1080.25.190LF	25
M32x1.5	18.0	21.0	36	32	1080.32.210LF	25
M32x1.5	21.0	25.0	36	32	1080.32.250LF	25
M40x1.5	24.0	28.5	46	34	1080.40.285LF	10
M40x1.5	28.5	32.0	46	34	1080.40.320LF	10
M50x1.5	33.0	37.0	55	36	1080.50.370LF	10
M50x1.5	37.0	41.0	55	36	1080.50.410LF	10
M63x1.5	40.0	46.0	70	39	1080.63.460LF	5
M63x1.5	46.0	50.0	70	39	1080.63.500LF	5

Auf Anfrage lieferbar: Available on request:
Anschlussgewinde Pg und NPT Entry thread Pg and NPT



Kabelverschraubungen Progress® AgreenO EMV Messing bleifrei mit Kontakthülse

Cable glands Progress® AgreenO EMC nickel-plated brass lead-free with contact sleeve

Langes Anschlussgewinde metrisch | Long entry thread metric

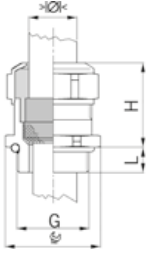

Material:	Messing CuZn21Si3P bleifrei	Material:	Brass CuZn21Si3P lead-free
Oberfläche:	Vernickelt	Surface:	Nickel-plated
Kontakthülse:	Messing CuZn21Si3P bleifrei	Contact sleeve:	Brass CuZn21Si3P lead-free
Dichtung:	TPE	Seal:	TPE
O-Ring:	NBR	O-ring:	NBR
Zugentlastung:	Ausführung A nach EN 62444	Strain relief:	Version A acc. to EN 62444
Schutzart:	IP 68 (bis 10 bar) / IP 69	Protection class:	IP 68 (up to 10 bar) / IP 69
Eigenschaften:	Sehr guter Schirmkontakt über die Kontakthülse bei in der Kabelverschraubung endendem Schirmgeflecht	Properties:	Excellent shield contact through the contact sleeve with the braided shield terminating in the screwed cable gland
Einsatztemperatur:	-40 °C / +100 °C	Operation temperature:	-40 °C / +100 °C



Einteiliger Dichteinsatz
nicht durchgehend isolierend

One-piece sealing insert
not overall length insulated

G	>math>D</math> min mm	>math>D</math> max mm	>math>S</math> mm	H mm	L mm	Art.-No.	
M12x1.5	4.5	6.0	15	20	10	1180.12.060LF	50
M12x1.5	6.0	7.5	15	20	10	1180.12.075LF	50
M16x1.5	6.0	8.0	18	23	10	1180.17.080LF	50
M16x1.5	8.0	10.0	18	25	10	1180.17.100LF	50
M20x1.5	8.0	11.0	24	25	10	1180.20.110LF	50
M20x1.5	11.0	14.0	24	27	10	1180.20.140LF	50
M25x1.5	13.0	16.0	30	30	11	1180.25.160LF	25
M25x1.5	16.0	19.0	30	33	11	1180.25.190LF	25
M32x1.5	18.0	21.0	36	32	13	1180.32.210LF	25
M32x1.5	21.0	25.0	36	32	13	1180.32.250LF	25
M40x1.5	24.0	28.5	46	34	13	1180.40.285LF	10
M40x1.5	28.5	32.0	46	34	13	1180.40.320LF	10
M50x1.5	33.0	37.0	55	36	14	1180.50.370LF	10
M50x1.5	37.0	41.0	55	36	14	1180.50.410LF	10
M63x1.5	40.0	46.0	70	39	14	1180.63.460LF	5
M63x1.5	46.0	50.0	70	39	14	1180.63.500LF	5

Auf Anfrage lieferbar:
Anschlussgewinde Pg und NPT

Available on request:
Entry thread Pg and NPT



Gegenmutter AgreenO Messing bleifrei Lock nuts AgreenO nickel-plated brass lead-free

Anschlussgewinde metrisch | Entry thread metric

Material: Messing CuZn21Si3P bleifrei
Oberfläche: Vernickelt
Ausführung: 6-kant
Einsatztemperatur: -60 °C / +200 °C

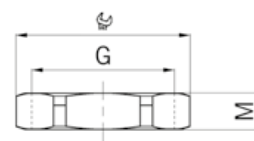
Material: Brass CuZn21Si3P lead-free
Surface: Nickel-plated
Execution: Hexagonal design
Operation temperature: -60 °C / +200 °C



Gewinde metrisch			Metric thread	
G	 mm	M mm	Art.-No.	
M12x1.5	15	3.5	8000.12LF	100
M16x1.5	19	3.5	8000.17LF	100
M20x1.5	24	4.0	8000.20LF	100
M25x1.5	30	4.0	8000.25LF	50
M32x1.5	36	5.0	8000.32LF	25
M40x1.5	46	5.3	8000.40LF	25
M50x1.5	55	6.3	8000.50LF	10
M63x1.5	70	7.0	8000.63LF	10

Auf Anfrage lieferbar: Available on request:
Anschlussgewinde Pg Entry thread Pg





Anschlussgewinde metrisch | Entry thread metric

Material: Messing CuZn21Si3P bleifrei
Oberfläche: Vernickelt
Ausführung: 6-kant
Eigenschaften: EMV-Gegenmutter mit Schneidezähnen für eine optimale Kontaktierung
Einsatztemperatur: -60 °C / +200 °C

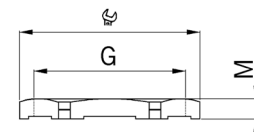
Material: Brass CuZn21Si3P lead-free
Surface: Nickel-plated
Execution: Hexagonal design
Properties: EMC lock nut with cutting teeth for optimised shield contact
Operation temperature: -60 °C / +200 °C



Gewinde metrisch			Metric thread	
G	 mm	M mm	Art.-No.	
M12x1.5	15	3.0	8012.85LF	25
M16x1.5	19	3.0	8017.85LF	25
M20x1.5	24	3.5	8020.85LF	25
M25x1.5	30	4.0	8025.85LF	10
M32x1.5	36	4.0	8032.85LF	10
M40x1.5	46	5.0	8040.85LF	10
M50x1.5	55	5.5	8050.85LF	10
M63x1.5	70	6.0	8063.85LF	10

Auf Anfrage lieferbar: Available on request:
Anschlussgewinde Pg Entry thread Pg



AGRO Kombi-Schlauchverschraubung aus Messing

AGRO Combination conduit gland nickel-plated brass

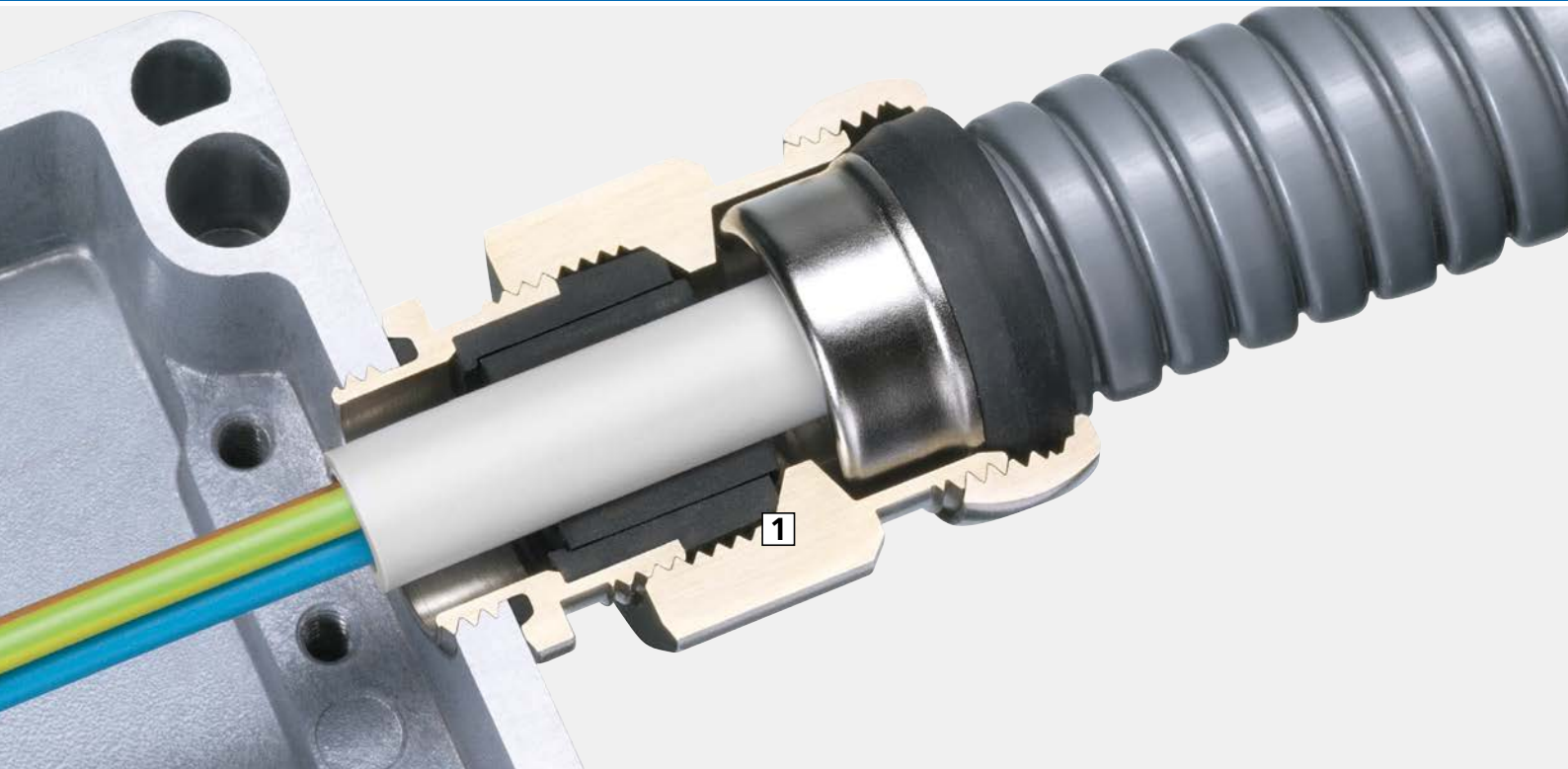

AGRO Kombi-Schlauchverschraubungen sind eine optimale Lösung, wenn Sie Kabel in einem Schutzschlauch in ein Gehäuse einführen wollen und gleichzeitig eine sichere Abdichtung und Zugentlastung des Kabels möchten.

1 Dichtheit

Mit der integrierten Kabelverschraubung erzielen Sie eine hervorragende Dichtheit (IP 68) im Innenbereich des Schutzschlauchs. So verhindern Sie das Eindringen von Flüssigkeiten und Kondenswasser.

Integrierte EMV-Kabelverschraubung

Die Kombi-Schlauchverschraubung gibt es auch als kombinierte Variante für geschirmte Kabel.

Kommen Kombi-Schlauchverschraubungen in **Bahnapplikationen** zum Einsatz – etwa weil Kabel in Schutzschläuchen geführt werden, um sie vor Schlägen oder Manipulation zu schützen – so gelten für sie die selben Anforderungen wie für Kabelverschraubungen: sie müssen mit einem Dichteinsatz aus Spezial-TPE gemäss **EN 45545** bestückt werden.

AGRO combination conduit glands are an optimal solution if you want to route cables inside a conduit into an enclosure and at the same time want a secure seal and strain relief for the cables.

1 Sealing capability



The integrated cable gland achieves excellent sealing (IP 68) inside the conduit. In this way, you make certain that water and condensate cannot make its way inside.

Integrated EMC cable gland

The combination conduit gland is also available in a special version for shielded cables.

In cases where combination conduit glands are used for **railway applications** – for instance when cables are laid in conduits in order to protect them from impacts or tampering – the same requirements apply as for cable glands: the combination conduit glands must be equipped with a sealing insert made of special TPE according to the requirements of **EN 45545**.



<p>AGRO Kombi-Schlauchverschraubung Progress® Messing mit integrierter Kabelverschraubung AGRO Combination conduit glands Progress® nickel-plated brass with integrated cable gland</p>	 <p>198 - 200</p>	1
<p>AGRO Adapter Progress® Messing mit integrierter Kabelverschraubung AGRO Adapter Progress® nickel-plated brass with integrated cable gland</p>	 <p>201 - 202</p>	2
<p>AGRO Kombi-Schlauchverschraubung Progress® EMV Messing mit integrierter Kabelverschraubung AGRO Combination conduit glands Progress® EMC nickel-plated brass with integrated cable gland</p>	 <p>203 - 205</p>	3
<p>AGRO Adapter Progress® Messing mit integrierter EMV-Kabelverschraubung AGRO Adapters Progress® nickel-plated brass with integrated EMC cable gland</p>	 <p>206 - 207</p>	4
<p>AGRO Kombi-EMV-Schlauchverschraubung für Kupfer-Hohlgeflechte AGRO Combination EMC conduit gland for copper braidings</p>	 <p>208</p>	5
<p>Zubehör zu Schlauchverschraubungen Conduit gland accessories</p>	 <p>209</p>	6

1

2

3

4

5

6

7

8

9

10

11

12

13

14

15

Kurzes Anschlussgewinde metrisch | Short entry thread metric

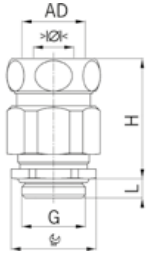

Material:	Messing vernickelt	Material:	Nickel-plated brass
Dichtung:	TPE	Seal:	TPE
O-Ring:	NBR	O-ring:	NBR
Zugentlastung:	Ausführung A nach EN 62444	Strain relief:	Version A acc. to EN 62444
Schutzart:	Kabelverschraubung IP 68	Protection class:	Cable gland IP 68
Hinweis:	Der max. Klemmbereich ist abhängig vom Schlauch-Innendurchmesser	Note:	The max. clamping range depends on the conduit inner diameter
Einsatztemperatur:	-40 °C / +100 °C	Operation temperature:	-40 °C / +100 °C



Progress MS Kombi



Für Schlauchanschluss AD mm
Zweiteiliger Dichteinsatz
nicht durchgehend isolierend

Connector for tubing with AD mm
Two-piece sealing insert
not overall length insulated

G	AD mm	> Ø < min mm	> Ø < max mm	> Ø < min mm	> Ø < max mm	mm	H mm	L mm	Art.-No.	
M12x1.5	10	-	-	5.0	6.5	15/17	33	5	1700.12.10	50
M16x1.5	14	6.0	8.0	8.0	10.5	18/21	38	5	1700.17.14	50
M20x1.5	17	8.0	11.0	11.0	15.0	24/25	38	6	1700.20.17	25
M20x1.5	19	8.0	11.0	11.0	15.0	24/27	39	6	1700.20.19	25
M20x1.5	21	8.0	11.0	11.0	15.0	24/29	39	6	1700.20.21	25
M25x1.5	21	12.5	16.0	16.0	20.5	30/29	43	7	1700.25.21	25
M25x1.5	27	12.5	16.0	16.0	20.5	30/36	50	7	1700.25.27	25
M32x1.5	27	17.0	21.0	21.0	25.5	36/36	52	8	1700.32.27	25
M40x1.5	36	24.0	28.5	28.5	33.0	46/45	56	8	1700.40.36	10
M50x1.5	45	33.0	37.0	37.0	42.0	55/54	60	9	1700.50.45	10
M63x1.5	56	40.0	46.0	46.0	52.0	70/66	67	10	1700.63.56	5

Je nach Schlauchtyp muss die passende Stabilisierungshülse separat bestellt werden.

Depending on the type of conduit, the stabilising bush must be ordered separately.

Erhältlich mit Dichteinsatz gemäss EN 45545 / NFPA 130. Bei Anfragen oder Bestellung bitte ein F vor die Artikelnummer setzen.

Available with sealing inserts conformity with EN 45545 / NFPA 130. When placing an inquiry, prefix the article number by the capital F.



Progress MS Kombi



Für Schlauchanschluss AD Zoll
Zweiteiliger Dichteinsatz
nicht durchgehend isolierend

Connector for tubing with AD in inches
Two-piece sealing insert
not overall length insulated

G	AD mm	> Ø < min mm	> Ø < max mm	> Ø < min mm	> Ø < max mm	mm	H mm	L mm	Art.-No.	
M12x1.5	1/4"	-	-	5.0	6.5	15/19	35	5	1700.12.1/4	50
M20x1.5	3/8"	8.0	11.0	11.0	15.0	24/27	42	6	1700.20.3/8	25
M20x1.5	1/2"	8.0	11.0	11.0	15.0	24/29	38	6	1700.20.1/2	25
M25x1.5	3/4"	12.5	16.0	16.0	20.5	30/36	52	7	1700.25.3/4	25
M32x1.5	1"	17.0	21.0	21.0	25.5	36/45	55	8	1700.32.1	25
M40x1.5	1 1/4"	24.0	28.5	28.5	33.0	46/54	62	8	1700.40.11/4	10
M63x1.5	2"	40.0	46.0	46.0	52.0	70/70	74	10	1700.63.2	5

Je nach Schlauchtyp muss die passende Stabilisierungshülse separat bestellt werden.

Depending on the type of conduit, the stabilising bush must be ordered separately.

Erhältlich mit Dichteinsatz gemäss EN 45545 / NFPA 130. Bei Anfragen oder Bestellung bitte ein F vor die Artikelnummer setzen.

Available with sealing inserts conformity with EN 45545 / NFPA 130. When placing an inquiry, prefix the article number by the capital F.

Langes Anschlussgewinde metrisch | Long entry thread metric

Material:	Messing vernickelt	Material:	Nickel-plated brass
Dichtung:	TPE	Seal:	TPE
O-Ring:	NBR	O-ring:	NBR
Zugentlastung:	Ausführung A nach EN 62444	Strain relief:	Version A acc. to EN 62444
Schutzart:	Kabelverschraubung IP 68	Protection class:	Cable gland IP 68
Hinweis:	Der max. Klemmbereich ist abhängig vom Schlauch-Innendurchmesser	Note:	The max. clamping range depends on the conduit inner diameter
Einsatztemperatur:	-40 °C / +100 °C	Operation temperature:	-40 °C / +100 °C

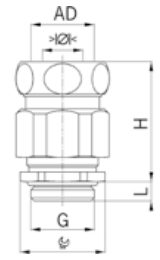

Für Schlauchanschluss AD mm
Zweiteiliger Dichteinsatz durchgehend isolierend

Connector for tubing with AD mm
Two-piece sealing insert overall length insulated

G	AD mm	> < < min mm	> < < max mm	> < < min mm	> < < max mm	 mm	H mm	L mm	Art.-No.	
M12x1.5	10	-	-	5.0	6.5	15/17	33	10	1710.60.12.10	50
M16x1.5	14	6.0	8.0	8.0	10.5	18/21	38	10	1710.60.17.14	50
M20x1.5	17	8.0	11.0	11.0	14.5	24/25	38	10	1710.60.20.17	25
M20x1.5	19	8.0	11.0	11.0	14.5	24/27	39	10	1710.60.20.19	25
M20x1.5	21	8.0	11.0	11.0	14.5	24/29	39	10	1710.60.20.21	25
M25x1.5	21	12.5	16.0	16.0	19.0	30/29	43	11	1710.60.25.21	25
M25x1.5	27	12.5	16.0	16.0	19.0	30/36	50	11	1710.60.25.27	25
M32x1.5	27	17.0	21.0	21.0	25.5	36/36	52	13	1710.60.32.27	25
M40x1.5	36	24.0	28.5	28.5	33.0	46/45	56	13	1710.60.40.36	10
M50x1.5	45	33.0	37.0	37.0	42.0	55/54	60	14	1710.60.50.45	10
M63x1.5	56	40.0	46.0	46.0	52.0	70/66	67	14	1710.60.63.56	5

Je nach Schlauchtyp muss die passende Stabilisierungshülse separat bestellt werden.

Erhältlich mit Dichteinsatz gemäss EN 45545 / NFPA 130. Bei Anfragen oder Bestellung bitte ein F vor die Artikelnummer setzen.

Depending on the type of conduit, the stabilising bush must be ordered separately.

Available with sealing inserts conformity with EN 45545 / NFPA 130. When placing an inquiry, prefix the article number by the capital F.



Progress MS Kombi



Für Schlauchanschluss AD Zoll
Zweiteiliger Dichteinsatz durchgehend isolierend

Connector for tubing with AD in inches
Two-piece sealing insert overall length insulated

G	AD mm	> < < min mm	> < < max mm	> < < min mm	> < < max mm	 mm	H mm	L mm	Art.-No.	
M12x1.5	1/4"	-	-	5.0	6.5	15/19	35	10	1710.60.12.1/4	50
M20x1.5	3/8"	8.0	11.0	11.0	14.5	24/27	42	10	1710.60.20.3/8	25
M20x1.5	1/2"	8.0	11.0	11.0	14.5	24/29	38	10	1710.60.20.1/2	25
M25x1.5	3/4"	12.5	16.0	16.0	19.0	30/36	52	11	1710.60.25.3/4	25
M32x1.5	1"	12.5	16.0	16.0	19.0	36/45	55	13	1710.60.32.1	25
M40x1.5	1 1/4"	24.0	28.5	28.5	33.0	46/54	62	13	1710.60.40.11/4	10
M63x1.5	2"	40.0	46.0	46.0	52.0	70/70	74	14	1710.60.63.2	5

Je nach Schlauchtyp muss die passende Stabilisierungshülse separat bestellt werden.

Erhältlich mit Dichteinsatz gemäss EN 45545 / NFPA 130. Bei Anfragen oder Bestellung bitte ein F vor die Artikelnummer setzen.

Depending on the type of conduit, the stabilising bush must be ordered separately.

Available with sealing inserts conformity with EN 45545 / NFPA 130. When placing an inquiry, prefix the article number by the capital F.



Progress MS Kombi



Kurzes Anschlussgewinde Pg | Short entry thread Pg

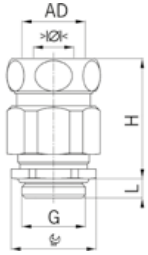

Material: Messing vernickelt
 Dichtung: TPE
 O-Ring: NBR
 Schutzart: Kabelverschraubung IP 68
 Hinweis: Der max. Klemmbereich ist abhängig vom Schlauch-Innendurchmesser
 Einsatztemperatur: -40 °C / +100 °C

Material: Nickel-plated brass
 Seal: TPE
 O-ring: NBR
 Protection class: Cable gland IP 68
 Note: The max. clamping range depends on the conduit inner diameter
 Operation temperature: -40 °C / +100 °C



Progress MS Kombi

UK
CA

Für Schlauchanschluss AD mm
 Zweiteiliger Dichteinsatz
 nicht durchgehend isolierend

Connector for tubing with AD mm
 Two-piece sealing insert
 not overall length insulated

G	AD mm	>∅< min mm	>∅< max mm	>∅< min mm	>∅< max mm	∅ mm	H mm	L mm	Art.-No.	
Pg 7	10	-	-	5.0	6.5	15/17	33	6	1700.07.10	50
Pg 9	14	6.0	8.0	8.0	10.5	18/21	38	6	1700.09.14	50
Pg 11	14	5.5	8.5	8.5	12.0	21/21	39	6	1700.11.14	50
Pg 11	17	5.5	8.5	8.5	12.0	21/25	39	6	1700.11.17	50
Pg 13	19	8.0	11.0	11.0	15.0	24/27	39	6	1700.13.19	25
Pg 16	17	8.0	11.0	11.0	15.0	24/25	38	6	1700.16.17	25
Pg 16	21	8.0	11.0	11.0	15.0	24/29	39	6	1700.16.21	25
Pg 21	27	12.5	16.0	16.0	20.5	30/36	50	7.5	1700.21.27	25
Pg 29	36	19.0	23.0	23.0	27.5	38/45	55	8	1700.29.36	25
Pg 36	45	26.0	30.5	30.5	35.0	50/54	60	8	1700.36.45	10
Pg 42	45	33.0	37.0	37.0	42.0	55/54	60	10	1700.42.45	10
Pg 48	56	37.0	43.0	43.0	49.0	65/66	67	11	1700.48.56	10

Je nach Schlauchtyp muss die passende Stabilisierungshülse separat bestellt werden.

Depending on the type of conduit, the stabilising bush must be ordered separately.

Erhältlich mit Dichteinsatz gemäss EN 45545 / NFPA 130. Bei Anfragen oder Bestellung bitte ein F vor die Artikelnummer setzen.

Available with sealing inserts conformity with EN 45545 / NFPA 130. When placing an inquiry, prefix the article number by the capital F.

Langes Anschlussgewinde Pg | Long entry thread Pg



Progress MS Kombi

UK
CA

Für Schlauchanschluss AD mm
 Zweiteiliger Dichteinsatz
 durchgehend isolierend

Connector for tubing with AD mm
 Two-piece sealing insert
 overall length insulated

G	AD mm	>∅< min mm	>∅< max mm	>∅< min mm	>∅< max mm	∅ mm	H mm	L mm	Art.-No.	
Pg 7	10	-	-	5.0	6.5	15/17	33	10	1710.60.07.10	50
Pg 9	14	6.0	8.0	8.0	10.5	18/21	38	10	1710.60.09.14	50
Pg 11	14	5.5	8.5	8.5	12.0	21/21	39	10	1710.60.11.14	50
Pg 11	17	5.5	8.5	8.5	12.0	21/25	39	10	1710.60.11.17	50
Pg 13	19	8.0	11.0	11.0	14.5	24/27	39	10	1710.60.13.19	25
Pg 16	17	8.0	11.0	11.0	14.5	24/25	38	10	1710.60.16.17	25
Pg 16	21	8.0	11.0	11.0	14.5	24/29	39	10	1710.60.16.21	25
Pg 21	27	12.5	16.0	16.0	19.0	30/36	50	12	1710.60.21.27	25
Pg 29	36	19.0	23.0	23.0	27.5	38/45	55	12	1710.60.29.36	25
Pg 36	45	26.0	30.5	30.5	35.0	50/54	60	15	1710.60.36.45	10
Pg 42	45	33.0	37.0	37.0	42.0	55/54	60	15	1710.60.42.45	10
Pg 48	56	37.0	43.0	43.0	49.0	65/66	67	15	1710.60.48.56	10

Je nach Schlauchtyp muss die passende Stabilisierungshülse separat bestellt werden.

Depending on the type of conduit, the stabilising bush must be ordered separately.

Erhältlich mit Dichteinsatz gemäss EN 45545 / NFPA 130. Bei Anfragen oder Bestellung bitte ein F vor die Artikelnummer setzen.

Available with sealing inserts conformity with EN 45545 / NFPA 130. When placing an inquiry, prefix the article number by the capital F.

AGRO Adapter Progress® Messing mit integrierter Kabelverschraubung

AGRO Adapter Progress® nickel-plated brass with integrated cable gland

Langes Anschlussgewinde metrisch | Long entry thread metric

Material:	Messing vernickelt	Material:	Nickel-plated brass
Dichtung:	TPE	Seal:	TPE
O-Ring:	NBR	O-ring:	NBR
Zugentlastung:	Ausführung A nach EN 62444	Strain relief:	Version A acc. to EN 62444
Schutzart:	Kabelverschraubung IP 68	Protection class:	Cable gland IP 68
Hinweis:	Der max. Klemmbereich ist abhängig vom Schlauch-Innendurchmesser	Note:	The max. clamping range depends on the conduit inner diameter
Einsatztemperatur:	-40 °C / +100 °C	Operation temperature:	-40 °C / +100 °C



Einteiliger Dichteinsatz durchgehend isolierend

One-piece sealing insert overall length insulated

G	I	>Ø< min mm	>Ø< max mm	mm	H mm	L mm	i info	Art.-No.	
M10x1.5	M10x1.5	4.0	6.0	13	30	10	1	1165.10	50
M12x1.5	M12x1.5	5.0	6.5	15	32	10	-	1165.12	50

1 = Metrisches Regelgewinde (mit VDE Testreport)

1 = Metric coarse-pitch thread (with VDE test report)

Erhältlich mit Dichteinsatz gemäss EN 45545 / NFPA 130. Bei Anfragen oder Bestellung bitte ein F vor die Artikelnummer setzen.

Available with sealing inserts conformity with EN 45545 / NFPA 130. When placing an inquiry, prefix the article number by the capital F.



Progress MS Adapter



Zweiteiliger Dichteinsatz durchgehend isolierend

Two-piece sealing insert overall length insulated

G	I	>Ø< min mm	>Ø< max mm	>Ø< min mm	>Ø< max mm	mm	H mm	L mm	Art.-No.	
M16x1.5	M16x1.5	6.0	8.0	8.0	10.5	18	35	10	1165.17	50
M20x1.5	M20x1.5	8.0	11.0	11.0	14.5	24	36	10	1165.20	25
M25x1.5	M25x1.5	12.5	16.0	16.0	19.0	30	41	11	1165.25	25
M32x1.5	M32x1.5	17.0	21.0	21.0	25.5	36	46	13	1165.32	25
M40x1.5	M40x1.5	24.0	28.5	28.5	33.0	46	48	13	1165.40	10
M50x1.5	M50x1.5	33.0	37.0	37.0	42.0	55	53	14	1165.50	5
M63x1.5	M63x1.5	40.0	46.0	46.0	52.0	70	56	14	1165.63	5

Erhältlich mit Dichteinsatz gemäss EN 45545 / NFPA 130. Bei Anfragen oder Bestellung bitte ein F vor die Artikelnummer setzen.

Available with sealing inserts conformity with EN 45545 / NFPA 130. When placing an inquiry, prefix the article number by the capital F.



Progress MS Adapter



AGRO Adapter Progress® Messing mit integrierter Kabelverschraubung

AGRO Adapter Progress® nickel-plated brass with integrated cable gland

Langes Anschlussgewinde Pg | Long entry thread Pg

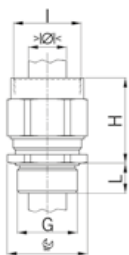

Material: Messing vernickelt
 Dichtung: TPE
 O-Ring: NBR
 Schutzart: Kabelverschraubung IP 68
 Hinweis: Der max. Klemmbereich ist abhängig vom Schlauch-Innendurchmesser
 Einsatztemperatur: -40 °C / +100 °C

Material: Nickel-plated brass
 Seal: TPE
 O-ring: NBR
 Protection class: Cable gland IP 68
 Note: The max. clamping range depends on the conduit inner diameter
 Operation temperature: -40 °C / +100 °C



Einteiliger Dichteinsatz durchgehend isolierend

One-piece sealing insert overall length insulated

G	I	$\begin{matrix} > \ominus < \\ \text{min mm} \end{matrix}$	$\begin{matrix} > \ominus < \\ \text{max mm} \end{matrix}$	$\begin{matrix} \text{mm} \\ \text{mm} \end{matrix}$	H	L
Pg 7	Pg 7	5.0	6.5	15	30	10

Art.-No.



1165.07

50

Erhältlich mit Dichteinsatz gemäss EN 45545 / NFPA 130. Bei Anfragen oder Bestellung bitte ein F vor die Artikelnummer setzen.

Available with sealing inserts conformity with EN 45545 / NFPA 130. When placing an inquiry, prefix the article number by the capital F.

Progress MS Adapter

UK
CA



Zweiteiliger Dichteinsatz durchgehend isolierend

Two-piece sealing insert overall length insulated

G	I	$\begin{matrix} > \ominus < \\ \text{min mm} \end{matrix}$	$\begin{matrix} > \ominus < \\ \text{max mm} \end{matrix}$	$\begin{matrix} > \ominus < \\ \text{min mm} \end{matrix}$	$\begin{matrix} > \ominus < \\ \text{max mm} \end{matrix}$	$\begin{matrix} \text{mm} \\ \text{mm} \end{matrix}$	H	L
Pg 9	Pg 9	6.0	8.0	8.0	10.5	18	35	10
Pg 11	Pg 11	5.5	8.5	8.5	12.0	21	36	10
Pg 13	Pg 13	8.0	11.0	11.0	14.5	24	36	10
Pg 16	Pg 16	8.0	11.0	11.0	14.5	24	37	10
Pg 21	Pg 21	12.5	16.0	16.0	19.0	30	42	12
Pg 29	Pg 29	19.0	23.0	23.0	27.5	38/40	45	12
Pg 36	Pg 36	26.0	30.5	30.5	35.0	50	52	15
Pg 48	Pg 48	37.0	43.0	43.0	49.0	65	56	15

Art.-No.



1165.09

50

1165.11

50

1165.13

25

1165.16

25

1165.21

25

1165.29

25

1165.36

10

1165.48

5

Erhältlich mit Dichteinsatz gemäss EN 45545 / NFPA 130. Bei Anfragen oder Bestellung bitte ein F vor die Artikelnummer setzen.

Available with sealing inserts conformity with EN 45545 / NFPA 130. When placing an inquiry, prefix the article number by the capital F.

Progress MS Adapter

UK
CA

Langes Anschlussgewinde metrisch | Long entry thread metric

Material:	Messing vernickelt	Material:	Nickel-plated brass
Dichtung:	TPE	Seal:	TPE
O-Ring:	NBR	O-ring:	NBR
Zugentlastung:	Ausführung A nach EN 62444	Strain relief:	Version A acc. to EN 62444
Schutzart:	Kabelverschraubung IP 68	Protection class:	Cable gland IP 68
Hinweis:	Der max. Klemmbereich ist abhängig vom Schlauch-Innendurchmesser	Note:	The max. clamping range depends on the conduit inner diameter
Eigenschaften:	Sehr guter Schirmkontakt über die Kontakthülse bei in der Kabelverschraubung endendem Schirmgeflecht	Properties:	Excellent shield contact through the contact sleeve with the braided shield terminating in the screwed cable gland
Einsatztemperatur:	-40 °C / +100 °C	Operation temperature:	-40 °C / +100 °C

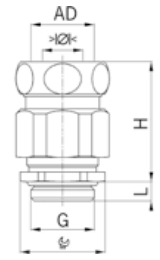

Einteiliger Dichteinsatz nicht durchgehend isolierend		One-piece sealing insert not overall length insulated					
G	AD mm	>Ø< min mm	>Ø< max mm	H mm	L mm	Art.-No.	
M12x1.5	10	4.5	6.0	15-17	35	1710.80.12.060.1	25
M16x1.5	14	6.0	8.0	18/21	40	1710.80.17.080.1	25
M16x1.5	14	8.0	10.0	18/21	40	1710.80.17.100.1	25
M20x1.5	17	8.0	11.0	24/25	42	1710.80.20.110.1	25
M20x1.5	17	11.0	14.0	24/25	42	1710.80.20.140.1	25
M20x1.5	19	8.0	11.0	24/27	43	1710.80.20.110.2	25
M20x1.5	19	11.0	14.0	24/27	43	1710.80.20.140.2	25
M25x1.5	21	13.0	16.0	30/29	48	1710.80.25.160.1	25
M25x1.5	27	16.0	19.0	30/36	52	1710.80.25.190.1	25
M32x1.5	27	18.0	21.0	36/36	55	1710.80.32.210.1	10
M32x1.5	27	21.0	25.0	36/36	55	1710.80.32.250.1	10
M40x1.5	36	24.0	28.5	46/45	60	1710.80.40.285.1	10
M40x1.5	36	28.5	32.0	46/45	60	1710.80.40.320.1	10
M50x1.5	45	33.0	37.0	55/54	62	1710.80.50.370.1	5
M50x1.5	45	37.0	41.0	55/54	62	1710.80.50.410.1	5
M63x1.5	56	40.0	46.0	70/66	69	1710.80.63.460.1	5
M63x1.5	56	46.0	50.0	70/66	69	1710.80.63.500.1	5

Je nach Schlauchtyp muss die passende Stabilisierungshülse separat bestellt werden.
 Erhältlich mit Dichteinsatz gemäss EN 45545 / NFPA 130. Bei Anfragen oder Bestellung bitte ein F vor die Artikelnummer setzen.

Depending on the type of conduit, the stabilising bush must be ordered separately.
 Available with sealing inserts conformity with EN 45545 / NFPA 130. When placing an inquiry, prefix the article number by the capital F.



Progress MS Kombi EMC



1
2
3
4
5
6
7
8
9
10
11
12
13
14
15

Langes Anschlussgewinde metrisch | Long entry thread metric

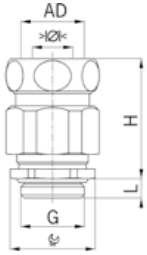

Material:	Messing vernickelt	Material:	Nickel-plated brass
Dichtung:	TPE	Seal:	TPE
O-Ring:	NBR	O-ring:	NBR
Zugentlastung:	Ausführung A nach EN 62444	Strain relief:	Version A acc. to EN 62444
Schutzart:	Kabelverschraubung IP 68	Protection class:	Cable gland IP 68
Hinweis:	Der max. Klemmbereich ist abhängig vom Schlauch-Innendurchmesser	Note:	The max. clamping range depends on the conduit inner diameter
Eigenschaften:	Sehr guter Schirmkontakt über die Kontakthülse bei in der Kabelverschraubung endendem Schirmgeflecht	Properties:	Excellent shield contact through the contact sleeve with the braided shield terminating in the screwed cable gland
Einsatztemperatur:	-40 °C / +100 °C	Operation temperature:	-40 °C / +100 °C



Progress MS Kombi EMC



Einteiliger Dichteinsatz
nicht durchgehend isolierend

One-piece sealing insert
not overall length insulated

G	AD mm	> Ø < min mm	> Ø < max mm	Ø mm	H mm	L mm	Art.-No.	
M12x1.5	1/4"	4.5	6.0	15/19	35	10	1710.80.12.060.2	25
M16x1.5	5/16"	6.0	8.0	18/21	38	10	1710.80.17.080.2	25
M16x1.5	5/16"	8.0	10.0	18/21	38	10	1710.80.17.100.2	25
M20x1.5	3/8"	8.0	11.0	24/27	42	10	1710.80.20.110.3	25
M20x1.5	1/2"	8.0	11.0	24/29	38	10	1710.80.20.110.4	25
M20x1.5	1/2"	11.0	14.0	24/29	38	10	1710.80.20.140.4	25
M25x1.5	3/4"	13.0	16.0	30/36	52	11	1710.80.25.160.2	25
M25x1.5	3/4"	16.0	19.0	30/36	52	11	1710.80.25.190.2	25
M32x1.5	1"	18.0	21.0	36/45	55	13	1710.80.32.210.2	10
M32x1.5	1"	21.0	25.0	36/45	55	13	1710.80.32.250.2	10
M40x1.5	1 1/4"	24.0	28.5	46/54	62	13	1710.80.40.285.2	10
M40x1.5	1 1/4"	28.5	32.0	46/54	62	13	1710.80.40.320.2	10
M63x1.5	2"	40.0	46.0	70/70	74	14	1710.80.63.460.2	5
M63x1.5	2"	46.0	50.0	70/70	74	14	1710.80.63.500.2	5

Je nach Schlauchtyp muss die passende Stabilisierungshülse separat bestellt werden.

Depending on the type of conduit, the stabilising bush must be ordered separately.

Erhältlich mit Dichteinsatz gemäss EN 45545 / NFPA 130. Bei Anfragen oder Bestellung bitte ein F vor die Artikelnummer setzen.

Available with sealing inserts conformity with EN 45545 / NFPA 130. When placing an inquiry, prefix the article number by the capital F.

Langes Anschlussgewinde Pg | Long entry thread Pg

Material:	Messing vernickelt	Material:	Nickel-plated brass
Dichtung:	TPE	Seal:	TPE
O-Ring:	NBR	O-ring:	NBR
Schutzart:	Kabelverschraubung IP 68	Protection class:	Cable gland IP 68
Hinweis:	Der max. Klemmbereich ist abhängig vom Schlauch-Innendurchmesser	Note:	The max. clamping range depends on the conduit inner diameter
Eigenschaften:	Sehr guter Schirmkontakt über die Kontakthülse bei in der Kabelverschraubung endendem Schirmgeflecht	Properties:	Excellent shield contact through the contact sleeve with the braided shield terminating in the screwed cable gland
Einsatztemperatur:	-40 °C / +100 °C	Operation temperature:	-40 °C / +100 °C

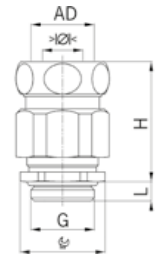

Einteiliger Dichteinsatz nicht durchgehend isolierend		One-piece sealing insert not overall length insulated						
G	AD mm	>D< min mm	>D< max mm		H mm	L mm	Art.-No.	
Pg 7	10	4.5	6.0	15/17	35	10	1710.80.07.060.1	25
Pg 9	14	6.0	8.0	18/21	40	10	1710.80.09.080.1	25
Pg 9	14	8.0	10.0	18/21	40	10	1710.80.09.100.1	25
Pg 11	17	8.5	12.0	21/25	41	10	1710.80.11.120.1	25
Pg 11	17	5.5	8.5	21/25	41	10	1710.80.11.085.1	25
Pg 13	19	8.0	11.0	24/27	42	10	1710.80.13.110.1	25
Pg 13	19	11.0	14.0	24/27	42	10	1710.80.13.140.1	25
Pg 16	21	8.0	11.0	24/29	43	10	1710.80.16.110.1	25
Pg 16	21	11.0	14.0	24/29	43	10	1710.80.16.140.1	25
Pg 21	27	13.0	16.0	30/36	55	12	1710.80.21.160.1	10
Pg 21	27	16.0	19.0	30/36	55	12	1710.80.21.190.1	10
Pg 29	36	19.0	23.0	38/45	57	12	1710.80.29.230.1	10
Pg 29	36	23.0	25.5	38/45	57	12	1710.80.29.255.1	10
Pg 36	45	25.0	30.5	50/54	62	15	1710.80.36.305.1	5
Pg 36	45	30.5	35.0	50/54	62	15	1710.80.36.350.1	5
Pg 42	45	33.0	37.0	55/54	62	15	1710.80.42.370.1	5
Pg 42	45	37.0	41.0	55/54	62	15	1710.80.42.410.1	5
Pg 48	56	39.0	43.0	65/66	69	15	1710.80.48.430.1	5
Pg 48	56	43.0	46.5	65/66	69	15	1710.80.48.465.1	5

Je nach Schlauchtyp muss die passende Stabilisierungshülse separat bestellt werden.
 Erhältlich mit Dichteinsatz gemäss EN 45545 / NFPA 130. Bei Anfragen oder Bestellung bitte ein F vor die Artikelnummer setzen.

Depending on the type of conduit, the stabilising bush must be ordered separately.
 Available with sealing inserts conformity with EN 45545 / NFPA 130. When placing an inquiry, prefix the article number by the capital F.



Progress MS Kombi EMC
UK CA

AGRO Adapter Progress® Messing mit integrierter EMV-Kabelverschraubung

AGRO Adapters Progress® nickel-plated brass with integrated EMC cable gland

Langes Anschlussgewinde metrisch | Long entry thread metric

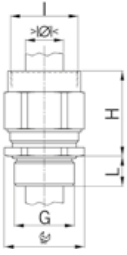

Material:	Messing vernickelt	Material:	Nickel-plated brass
Kontakthülse:	Messing vernickelt	Contact sleeve:	Nickel-plated brass
Dichtung:	TPE	Seal:	TPE
O-Ring:	NBR	O-ring:	NBR
Zugentlastung:	Ausführung A nach EN 62444	Strain relief:	Version A acc. to EN 62444
Schutzart:	Kabelverschraubung IP 68	Protection class:	Cable gland IP 68
Hinweis:	Der max. Klemmbereich ist abhängig vom Schlauch-Innendurchmesser	Note:	The max. clamping range depends on the conduit inner diameter
Eigenschaften:	Sehr guter Schirmkontakt über die Kontakthülse bei in der Kabelverschraubung endendem Schirmgeflecht	Properties:	Excellent shield contact through the contact sleeve with the braided shield terminating in the screwed cable gland
Einsatztemperatur:	-40 °C / +100 °C	Operation temperature:	-40 °C / +100 °C



Progress MS Kombi EMC



Einteiliger Dichteinsatz
nicht durchgehend isolierend

One-piece sealing insert
not overall length insulated

G	I	>10< min mm	>10< max mm	 mm	H mm	L mm	i info	Art.-No.	
M10x1.5	M10x1.5	3.0	4.0	13	32	10	1	1165.80.10.040	50
M10x1.5	M10x1.5	4.0	6.0	13	32	10	1	1165.80.10.060	50
M12x1.5	M12x1.5	4.5	6.0	15	34	10	-	1165.80.12.060	50
M12x1.5	M12x1.5	6.0	7.5	15	34	10	-	1165.80.12.075	50
M16x1.5	M16x1.5	6.0	8.0	18	38	10	-	1165.80.17.080	50
M16x1.5	M16x1.5	8.0	10.0	18	38	10	-	1165.80.17.100	50
M20x1.5	M20x1.5	8.0	11.0	24	40	10	-	1165.80.20.110	25
M20x1.5	M20x1.5	11.0	14.0	24	40	10	-	1165.80.20.140	25
M25x1.5	M25x1.5	13.0	16.0	30	46	11	-	1165.80.25.160	25
M25x1.5	M25x1.5	16.0	19.0	30	46	11	-	1165.80.25.190	25
M32x1.5	M32x1.5	18.0	21.0	36	49	13	-	1165.80.32.210	10
M32x1.5	M32x1.5	21.0	25.0	36	49	13	-	1165.80.32.250	10
M40x1.5	M40x1.5	24.0	28.5	46	51	13	-	1165.80.40.285	10
M40x1.5	M40x1.5	28.5	32.0	46	51	13	-	1165.80.40.320	5
M50x1.5	M50x1.5	33.0	37.0	55	55	14	-	1165.80.50.370	5
M50x1.5	M50x1.5	37.0	41.0	55	55	14	-	1165.80.50.410	5
M63x1.5	M63x1.5	40.0	46.0	70	59	14	-	1165.80.63.460	5
M63x1.5	M63x1.5	46.0	50.0	70	59	14	-	1165.80.63.500	5

1 = Metrisches Regelgewinde (mit VDE Testreport)

1 = Metric coarse-pitch thread (with VDE test report)

Erhältlich mit Dichteinsatz gemäss EN 45545 / NFPA 130.
Bei Anfragen oder Bestellung bitte ein F vor die Artikelnummer setzen.

Available with sealing inserts conformity with EN 45545 / NFPA 130. When placing an inquiry, prefix the article number by the capital F.

AGRO Adapter Progress® Messing mit integrierter EMV-Kabelverschraubung

AGRO Adapters Progress® nickel-plated brass with integrated EMC cable gland

Langes Anschlussgewinde Pg | Long entry thread Pg

Material: Messing vernickelt
 Kontakthülse: Messing vernickelt
 Dichtung: TPE
 O-Ring: NBR
 Schutzart: Kabelverschraubung IP 68
 Hinweis: Der max. Klemmbereich ist abhängig vom Schlauch-Innendurchmesser
 Eigenschaften: Sehr guter Schirmkontakt über die Kontakthülse bei in der Kabelverschraubung endendem Schirmgeflecht
 Einsatztemperatur: -40 °C / +100 °C

Material: Nickel-plated brass
 Contact sleeve: Nickel-plated brass
 Seal: TPE
 O-ring: NBR
 Protection class: Cable gland IP 68
 Note: The max. clamping range depends on the conduit inner diameter
 Properties: Excellent shield contact through the contact sleeve with the braided shield terminating in the screwed cable gland
 Operation temperature: -40 °C / +100 °C

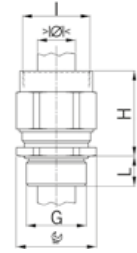

Einteiliger Dichteinsatz nicht durchgehend isolierend		One-piece sealing insert not overall length insulated					Art.-No.	
G	I	$\begin{matrix} > \ominus < \\ \text{min mm} & \text{max mm} \end{matrix}$	$\begin{matrix} > \ominus < \\ \text{min mm} & \text{max mm} \end{matrix}$		H	L		
				mm	mm	mm		
Pg 7	Pg 7	4.0	6.0	15	31	10	1165.80.07.060	50
Pg 7	Pg 7	6.0	7.5	15	31	10	1165.80.07.075	50
Pg 9	Pg 9	6.0	8.0	18	38	10	1165.80.09.080	50
Pg 9	Pg 9	8.0	10.0	18	38	10	1165.80.09.100	50
Pg 11	Pg 11	5.5	8.5	21	38	10	1165.80.11.085	50
Pg 11	Pg 11	8.5	12.0	21	38	10	1165.80.11.120	50
Pg 13	Pg 13	8.0	11.0	24	40	10	1165.80.13.110	25
Pg 13	Pg 13	11.0	14.0	24	40	10	1165.80.13.140	25
Pg 16	Pg 16	8.0	11.0	24	41	10	1165.80.16.110	25
Pg 16	Pg 16	11.0	14.0	24	41	10	1165.80.16.140	25
Pg 21	Pg 21	13.0	16.0	30	47	12	1165.80.21.160	10
Pg 21	Pg 21	16.0	19.0	30	47	12	1165.80.21.190	10
Pg 29	Pg 29	19.0	23.0	38/40	48	12	1165.80.29.230	10
Pg 29	Pg 29	23.0	25.5	38/40	48	12	1165.80.29.255	10
Pg 36	Pg 36	25.0	30.5	50	54	15	1165.80.36.305	10
Pg 36	Pg 36	30.5	35.0	50	54	15	1165.80.36.350	10
Pg 48	Pg 48	39.0	43.0	65	59	15	1165.80.48.430	5
Pg 48	Pg 48	43.0	46.5	65	59	15	1165.80.48.465	5

Erhältlich mit Dichteinsatz gemäss EN 45545 / NFPA 130. Bei Anfragen oder Bestellung bitte ein F vor die Artikelnummer setzen.

Available with sealing inserts conformity with EN 45545 / NFPA 130. When placing an inquiry, prefix the article number by the capital F.



Progress MS Kombi
EMC



AGRO Kombi-EMV-Schlauchverschraubung für Kupfer-Hohlgeflechte

AGRO combination EMC conduit gland for copper braidings

Anschlussgewinde metrisch | Entry thread metric



Material:	Messing vernickelt	Material:	Nickel-plated brass
Kontakthülse:	Messing vernickelt	Contact sleeve:	Nickel-plated brass
O-Ring:	NBR	O-ring:	NBR
Schutzart:	IP 68 (mit Rohrflex®-Ringwellschlauch)	Protection class:	IP 68 (together with Rohrflex® corrugated tube)
Eigenschaften:	Dank unserer Kombi-EMV-Schlauchverschraubung für Kupfer-Hohlgeflechte können die Geflechte problemlos auf Masse geführt werden. Eine Kontakthülse garantiert optimale und ausreissfeste Schirmkontaktierung und gleichzeitig eine vibrations sichere Einführung.	Properties:	Copper braidings may be terminated without any problem with our combination EMC conduit gland. A contact bushing grants optimal shield contact at the same time vibration-proof leading of cables.
Einsatztemperatur:	-40 °C / +120 °C	Operation temperature:	-40 °C / +120 °C



Passend zu ROHRflex® Wellschlauch

Suitable for ROHRflex® corrugated tubings

G	>Ø< min mm	>Ø< max mm	Ø _h mm	H mm	L mm	Art.-No.	
M20x1.5	2.5	10.0	24	34.5	10	1165.84.20.15	25
M25x1.5	5.0	16.0	30	35.5	11	1165.84.25.21	25
M32x1.5	12.0	20.0	36	36.5	13	1165.84.32.34	25
M40x1.5	16.0	27.0	46	45	13	1165.84.40.34	10
M50x1.5	20.0	35.0	55	46	14	1165.84.50.42	5
M63x1.5	25.0	45.0	70	49	14	1165.84.63.54	5



Druckring zu Schlauchverschraubungen Thrust collar for conduit glands

Druckring Messing zu Schlauchverschraubungen | Thrust collar brass for conduit glands

Material: Messing vernickelt
Einsatzbereich: Zur Erdung sowie als Potenzialausgleich bei Verwendung von Schläuchen mit Metallgeflecht im EMV-Einsatz
Einsatztemperatur: -40 °C / +250 °C

Material: Nickel-plated brass
Application: For grounding as well as potential equalization by use of conduits with metal braiding for shielding applications
Operation temperature: -40 °C / +250 °C

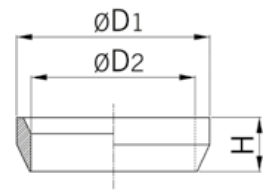

Zubehör zu Schlauchverschraubungen
Messing-Druckring

Conduit glands accessories
Thrust collar brass

AD mm	ØD1 mm	ØD2 mm	H mm	Art.-No.	
10	13	10.2	5.0	5031.034.007	50
14	17	14.5	5.0	5031.034.009	50
17	21	17.2	5.0	5031.034.011	50
19	23	19.2	6.0	5031.034.013	50
21	25	21.3	6.0	5031.034.016	50
27	32	27.3	8.5	5031.034.021	25
36	41	36.3	8.5	5031.034.029	25
45	50	45.3	8.5	5031.034.036	20
56	61	56.3	8.5	5031.034.048	10

Für EMV-Anwendungen Messingdruckring erforderlich! For EMC applications brass thrust collar necessary!



Dichtring Kunststoff zu Schlauchverschraubungen | Synthetic thrust collar for conduit glands

Material: PTFE (Teflon)
Einsatzbereich: Bei Verwendung von Schutzschläuchen mit Verschraubungen, geeignet für hohe Temperaturen
Einsatztemperatur: -60 °C / +300 °C

Material: PTFE (teflon)
Application: By using tubes with conduit glands suitable for high temperatures
Operation temperature: -60 °C / +300 °C

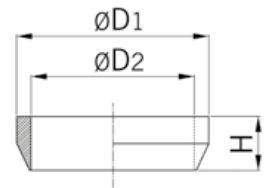

Zubehör zu Schlauchverschraubungen
Dichtring

Conduit glands accessories
Sealing ring

AD mm	ØD1 mm	ØD2 mm	H mm	Art.-No.	
10	13	10.3	6.0	5030.013.010	50
14	17	14.3	6.0	5030.013.014	50
17	21	17.3	6.0	5030.013.017	50
21	25	21.3	7.0	5030.013.021	50
27	32	27.4	9.5	5030.013.027	25
36	41	36.4	9.5	5030.013.036	25
45	50	45.4	9.5	5030.013.045	20
56	61	56.5	9.5	5030.013.056	10

Für hohe Temperaturen For high temperature applications



Kabelverschraubung Progress® Kunststoff

Progress® synthetic cable gland

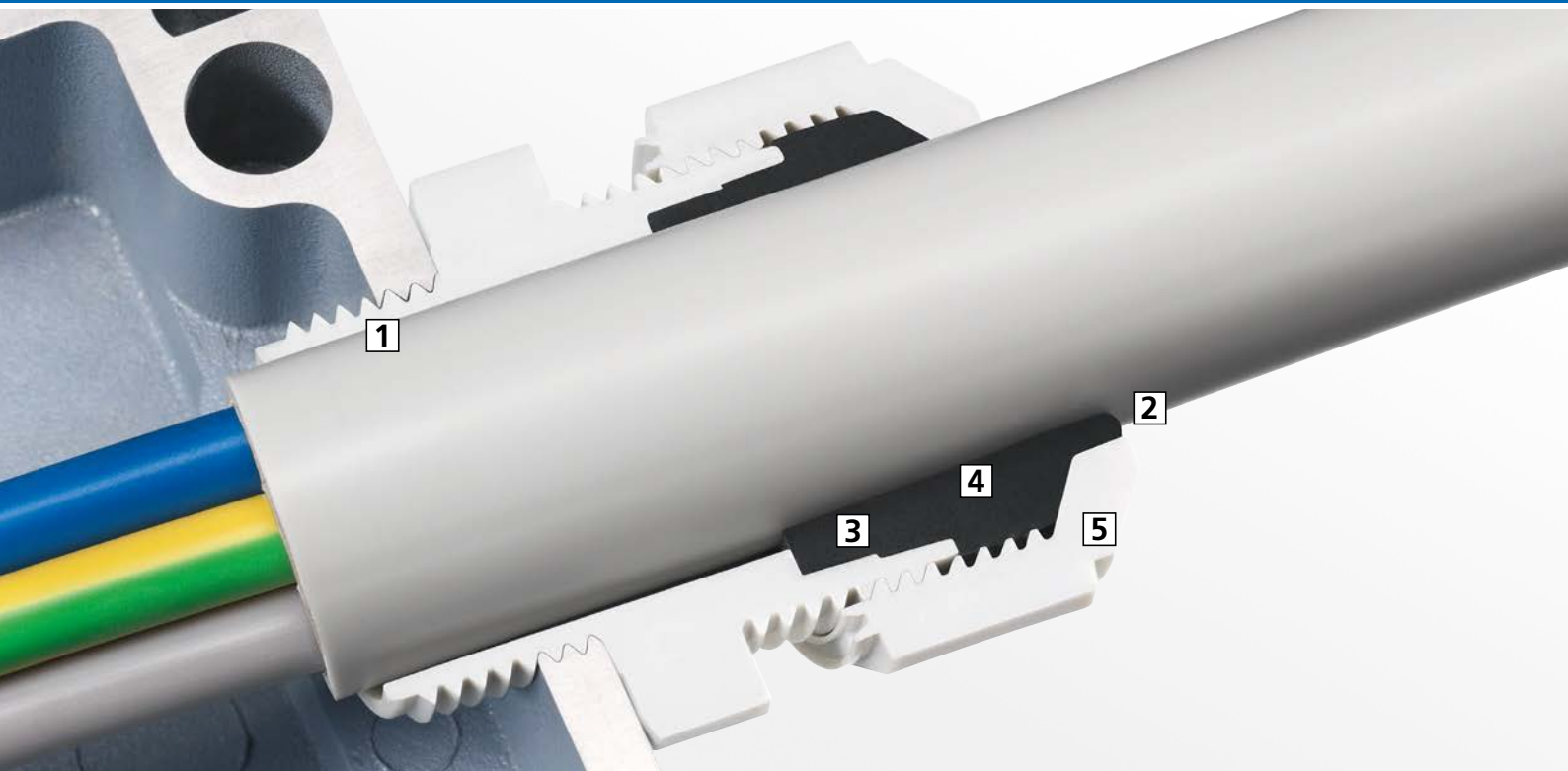

Kabelverschraubungen Progress® aus Kunststoff sind bewährte Helfer für die fachgerechte Kabeleinführung in Industrieanlagen. Die herausragende Kompressionstechnik sorgt für eine hohe Dichtigkeit und eine äusserst kabelschonende Zugentlastung.

1 Kurzes oder langes Anschlussgewinde

Kabelverschraubungen Progress® aus Kunststoff in metrischer oder Pg-Ausführung können bei vorhandenem Öffnungsgewinde oder mit Gegenmutter verwendet werden.

2 Sichtbare Sicherheit

Der kleine Wulst des Dichteinsatzes bestätigt das richtige Anzugsmoment.

3 Hoher Verdrehschutz

Der mit Halterippen ausgestattete Dichteinsatz sorgt für einen hohen Verdrehschutz.

4 Grosse Flexibilität

Zweiteilige Dichteinsätze können in Sekundenschnelle vor Ort auf den vorhandenen Kabeldurchmesser angepasst werden.

5 Garantierte Dichtigkeit

Auf den Dichteinsatz abgestimmte Innenkonturen sorgen für eine zielgerichtete Verformung des Dichteinsatzes und garantieren somit dessen perfekte Abdichtung.

Progress® synthetic cable glands are tried and tested aids for high-quality cable entries in industrial equipment. The outstanding compression technology ensures an effective seal and excellent cable-protecting strain relief.

1 Short or long connection thread

Progress® synthetic cable glands with metric or Pg designs can be used with existing hole threads or with a counter nut.

2 Visible reliability

A slight bulging of the sealing insert confirms the correct tightening torque.

3 Good anti-rotation protection

The sealing insert with its retaining ribs provides good anti-rotation protection.

4 Great flexibility

It only takes a few seconds to adapt the two-part sealing insert on site to the existing cable diameter.

5 Reliable leak-tightness

Inner contours matched to the sealing inserts insert ensure a targeted deformation of the insert and thus ensure its leak-tightness.

Dichteinsätze

Sealing inserts



Einteiliger Dichteinsatz
One-piece sealing insert





Zweiteiliger Dichteinsatz
Two-piece sealing insert



multiLAYER Dichteinsatz
multiLAYER sealing insert



Kabelverschraubungen Progress® multiLAYER Kunststoff GFK Synthetic cable glands Progress® multiLAYER GFK	 <p style="text-align: right;">212</p>
Kabelverschraubungen Progress® Kunststoff GFK Synthetic cable glands Progress® GFK	 <p style="text-align: right;">213 - 221</p>
Kabelverschraubungen Progress® Kunststoff GFK für mehrere Kabel Synthetic cable glands Progress® GFK for installation of multiple cables	 <p style="text-align: right;">214</p>

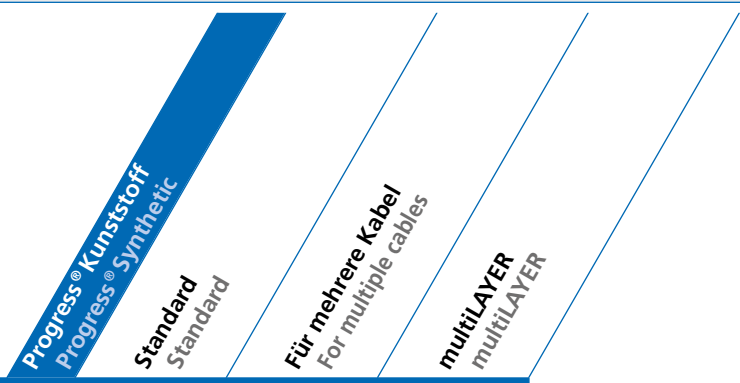

Ausführung / Design	Progress® Kunststoff Progress® Synthetic	Standard	Für mehrere Kabel For multiple cables	multiLAYER multiLAYER
Kompressionstechnik Compression technology		•	•	•
Gewinde / Thread				
Anschlussgewinde metrisch Entry thread metric		•	•	•
Anschlussgewinde Pg Entry thread Pg		•	•	-
Langes Anschlussgewinde Long entry thread		-	-	-
Dichteinsatz / Sealing insert				
Für Rundkabel For round cables		•	•	•
Für mehrere Kabel (Multi-Dichteinsatz) For multiple cables (Multi sealing insert)		•	•	-
Einteiliger Dichteinsatz One-piece sealing insert		•	•	-
Zweiteiliger Dichteinsatz Two-piece sealing insert		•	-	-
multiLAYER Dichteinsatz multiLAYER sealing insert		-	-	•
Technische Besonderheiten / Technical features				
Vibrationsschutz Vibration resistance		•	•	•
Farben / Colours				
Hellgrau RAL 7035 Light grey RAL 7035		•	•	•
Dunkelgrau RAL 7001 Dark grey RAL 7001		•	•	-
Schwarz RAL 9005 Black RAL 9005		•	•	•
Weiss RAL 9010 White RAL 9010		•	-	•
Graugrün RAL 7009 Greengreen RAL 7009		•	-	-

1
2
3
4
5
6
7
8
9
10
11
12
13
14
15

Anschlussgewinde metrisch | Entry thread metric

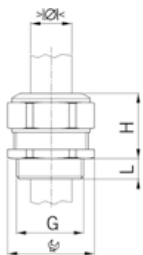

Material: Polyamid glasfaserverstärkt
 Eigenschaften: halogenfrei
 Dichtung: TPE
 Zugentlastung: Ausführung A nach EN 62444
 Schutzart: IP 68
 Einsatztemperatur: -20 °C / +100 °C

Material: Polyamide glass fiber reinforced
 Properties: halogen-free
 Seal: TPE
 Strain relief: Version A acc. to EN 62444
 Protection class: IP 68
 Operation temperature: -20 °C / +100 °C



Mehrteiliger Dichteinsatz
 Hellgrau RAL 7035

Multi-piece sealing insert
 Light grey RAL 7035

G	$\begin{matrix} > \varnothing < \\ \text{min mm} \end{matrix}$	$\begin{matrix} > \varnothing < \\ \text{max mm} \end{matrix}$	$\begin{matrix} \varnothing \\ \text{mm} \end{matrix}$	H mm	L mm	Art.-No.	
M20x1.5	4.0	15.0	27	28	13	1571.4.20	50
M25x1.5	6.0	20.5	34	33	13	1571.4.25	25
M32x1.5	10.0	25.5	41	35	15	1571.4.32	25



Mehrteiliger Dichteinsatz
 Schwarz RAL 9005

Multi-piece sealing insert
 Black RAL 9005

G	$\begin{matrix} > \varnothing < \\ \text{min mm} \end{matrix}$	$\begin{matrix} > \varnothing < \\ \text{max mm} \end{matrix}$	$\begin{matrix} \varnothing \\ \text{mm} \end{matrix}$	H mm	L mm	Art.-No.	
M20x1.5	4.0	15.0	27	28	13	1540.4.20	50
M25x1.5	6.0	20.5	34	33	13	1540.4.25	25
M32x1.5	10.0	25.5	41	35	15	1540.4.32	25



Mehrteiliger Dichteinsatz
 Weiss RAL 9010

Multi-piece sealing insert
 White RAL 9010

G	$\begin{matrix} > \varnothing < \\ \text{min mm} \end{matrix}$	$\begin{matrix} > \varnothing < \\ \text{max mm} \end{matrix}$	$\begin{matrix} \varnothing \\ \text{mm} \end{matrix}$	H mm	L mm	Art.-No.	
M20x1.5	4.0	15.0	27	28	13	1520.4.20	50
M25x1.5	6.0	20.5	34	33	13	1520.4.25	25

Kabelverschraubungen Progress® Kunststoff GFK

Synthetic cable glands Progress® GFK

Anschlussgewinde metrisch | Entry thread metric

Material:	Polyamid glasfaserverstärkt	Material:	Polyamide glass fiber reinforced
Eigenschaften:	halogenfrei	Properties:	halogen-free
Dichtung:	TPE	Seal:	TPE
Zugentlastung:	Ausführung A nach EN 62444	Strain relief:	Version A acc. to EN 62444
Schutzart:	IP 68	Protection class:	IP 68
Einsatztemperatur:	-20 °C / +100 °C	Operation temperature:	-20 °C / +100 °C

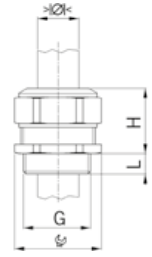

Hellgrau RAL 7035
Einteiliger Dichteinsatz

Light grey RAL 7035
One-piece sealing insert

G	>∅<	>∅<	∅	H	L	Art.-No.	
	min mm	max mm	mm	mm	mm		
M8x1.0	2.5	3.5	12	15.5	10	1571.08.035	50
M8x1.0	3.5	5.0	12	15.5	10	1571.08.050	50
M10x1.0	3.0	4.0	15	18.0	10	1571.10.040	50
M10x1.0	4.0	6.0	15	18.0	10	1571.10.060	50
M12x1.5	3.5	5.0	17	22.0	12	1571.12.050	50
M12x1.5	5.0	6.5	17	22.0	12	1571.12.065	50
M12x1.5	6.5	8.0	17	22.0	12	1571.12.080	50
M16x1.5	4.5	6.0	21	26.0	12	1571.17.060	50
M16x1.5	6.0	8.0	21	26.0	12	1571.17.080	50
M16x1.5	8.0	10.5	21	26.0	12	1571.17.105	50
M20x1.5	6.0	8.0	27	28.0	13	1571.20.080	50
M20x1.5	8.0	11.0	27	28.0	13	1571.20.110	50
M20x1.5	11.0	15.0	27	28.0	13	1571.20.150	50
M25x1.5	9.5	12.5	34	33.0	13	1571.25.125	25
M25x1.5	12.5	16.0	34	33.0	13	1571.25.160	25
M25x1.5	16.0	20.5	34	33.0	13	1571.25.205	25
M32x1.5	14.0	17.0	41	35.0	15	1571.32.170	25
M32x1.5	17.0	21.0	41	35.0	15	1571.32.210	25
M32x1.5	21.0	25.5	41	35.0	15	1571.32.255	25
M40x1.5	20.0	24.0	50	40.0	15	1571.40.240	10
M40x1.5	24.0	28.5	50	40.0	15	1571.40.285	10
M40x1.5	28.5	33.0	50	40.0	15	1571.40.330	10
M50x1.5	29.0	33.0	60	42.0	16	1571.50.330	10
M50x1.5	33.0	37.0	60	42.0	16	1571.50.370	10
M50x1.5	37.0	42.0	60	42.0	16	1571.50.420	10
M63x1.5	35.0	40.0	75	48.0	16	1571.63.400	5
M63x1.5	40.0	46.0	75	48.0	16	1571.63.460	5
M63x1.5	46.0	52.0	75	48.0	16	1571.63.520	5



Progress GFK



Hellgrau RAL 7035
Zweiteiliger Dichteinsatz

Light grey RAL 7035
Two-piece sealing insert

G	>∅<	>∅<	>∅<	>∅<	∅	H	L	Art.-No.	
	min mm	max mm	min mm	max mm	mm	mm	mm		
M16x1.5	6.0	8.0	8.0	10.5	21	26.0	12	1571.17	50
M20x1.5	8.0	11.0	11.0	15.0	27	28.0	13	1571.20	50
M25x1.5	12.5	16.0	16.0	20.5	34	33.0	13	1571.25	25
M32x1.5	17.0	21.0	21.0	25.5	41	35.0	15	1571.32	25
M40x1.5	24.0	28.5	28.5	33.0	50	40.0	15	1571.40	10
M50x1.5	33.0	37.0	37.0	42.0	60	42.0	16	1571.50	10
M63x1.5	40.0	46.0	46.0	52.0	75	48.0	16	1571.63	5



Progress GFK



Kabelverschraubungen Progress® Kunststoff GFK für mehrere Kabel Synthetic cable glands Progress® GFK for installation of multiple cables

Anschlussgewinde metrisch | Entry thread metric

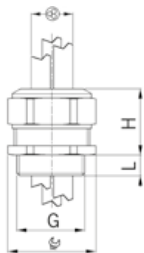

Material: Polyamid glasfaserverstärkt
Eigenschaften: halogenfrei
Dichtung: TPE
Zugentlastung: Ausführung A nach EN 62444
Schutzart: IP 68
Einsatztemperatur: -20 °C / +100 °C

Material: Polyamide glass fiber reinforced
Properties: halogen-free
Seal: TPE
Strain relief: Version A acc. to EN 62444
Protection class: IP 68
Operation temperature: -20 °C / +100 °C



Progress GFK Multi



Hellgrau RAL 7035
Einteiliger Dichteinsatz

Light grey RAL 7035
One-piece sealing insert

G	> Ø < min mm	> Ø < max mm	⊗ mm	Ⓜ mm	H mm	L mm	Art.-No.	
M16x1.5	2.0	3.0	2	21	26	12	1571.17.2.030	50
M16x1.5	2.5	4.0	2	21	26	12	1571.17.2.040	50
M16x1.5	3.5	5.0	2	21	26	12	1571.17.2.050	50
M20x1.5	3.5	5.0	2	27	28	13	1571.20.2.050	50
M20x1.5	4.5	6.0	2	27	28	13	1571.20.2.060	50
M20x1.5	5.5	7.5	2	27	28	13	1571.20.2.075	50
M20x1.5	3.5	5.0	3	27	28	13	1571.20.3.050	50
M20x1.5	4.5	6.0	3	27	28	13	1571.20.3.060	50
M20x1.5	5.2	6.5	3	27	28	13	1571.20.3.065	50
M20x1.5	3.5	5.0	4	27	28	13	1571.20.4.050	50
M20x1.5	4.5	6.0	4	27	28	13	1571.20.4.060	50
M25x1.5	5.0	7.0	2	34	33	13	1571.25.2.070	25
M25x1.5	6.7	9.0	2	34	33	13	1571.25.2.090	25
M25x1.5	7.7	10.0	2	34	33	13	1571.25.2.100	25
M25x1.5	5.5	7.0	3	34	33	13	1571.25.3.070	25
M25x1.5	6.8	9.0	3	34	33	13	1571.25.3.090	25
M25x1.5	5.5	7.0	4	34	33	13	1571.25.4.070	25
M25x1.5	4.8	6.0	6	34	33	13	1571.25.6.060	25
M32x1.5	9.0	11.5	2	41	35	15	1571.32.2.115	25
M32x1.5	7.0	9.0	3	41	35	15	1571.32.3.090	25
M32x1.5	8.5	10.5	3	41	35	15	1571.32.3.105	25
M32x1.5	7.0	9.0	4	41	35	15	1571.32.4.090	25
M32x1.5	5.8	7.0	6	41	35	15	1571.32.6.070	25

Weitere Ausführungen und Farben auf Anfrage: z.B. dunkelgrau RAL 7001, schwarz RAL 9005, grössere Anschlussgewinde

Additional versions and colours are available upon request: e.g. dark grey RAL 7001, black RAL 9005, larger entry threads

Kabelverschraubungen Progress® Kunststoff GFK

Synthetic cable glands Progress® GFK

Anschlussgewinde metrisch | Entry thread metric

Material: Agromid glasfaserverstärkt, wärmealterungs- und schlagzäh modifiziert

Eigenschaften: halogenfrei

Dichtung: TPE

Zugentlastung: Ausführung A nach EN 62444

Schutzart: IP 68

Einsatztemperatur: -30 °C / +100 °C

Material: Agromid glass fiber reinforced, heat aging and impact-resistant modified

Properties: halogen-free

Seal: TPE

Strain relief: Version A acc. to EN 62444

Protection class: IP 68

Operation temperature: -30 °C / +100 °C

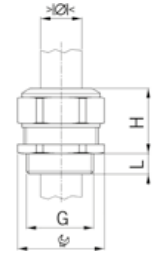

Dunkelgrau RAL 7001
Einteiliger Dichteinsatz

Dark grey RAL 7001
One-piece sealing insert

G	> Ø <	> Ø <	⊕	H	L	Art.-No.	
	min mm	max mm	mm	mm	mm		
M8x1.0	2.5	3.5	12	15.5	10	1572.08.035	50
M8x1.0	3.5	5.0	12	15.5	10	1572.08.050	50
M10x1.0	3.0	4.0	15	18.0	10	1572.10.040	50
M10x1.0	4.0	6.0	15	18.0	10	1572.10.060	50
M12x1.5	3.5	5.0	17	22.0	12	1572.12.050	50
M12x1.5	5.0	6.5	17	22.0	12	1572.12.065	50
M12x1.5	6.5	8.0	17	22.0	12	1572.12.080	50
M16x1.5	4.5	6.0	21	26.0	12	1572.17.060	50
M16x1.5	6.0	8.0	21	26.0	12	1572.17.080	50
M16x1.5	8.0	10.5	21	26.0	12	1572.17.105	50
M20x1.5	6.0	8.0	27	28.0	13	1572.20.080	50
M20x1.5	8.0	11.0	27	28.0	13	1572.20.110	50
M20x1.5	11.0	15.0	27	28.0	13	1572.20.150	50
M25x1.5	9.5	12.5	34	33.0	13	1572.25.125	25
M25x1.5	12.5	16.0	34	33.0	13	1572.25.160	25
M25x1.5	16.0	20.5	34	33.0	13	1572.25.205	25
M32x1.5	14.0	17.0	41	35.0	15	1572.32.170	25
M32x1.5	17.0	21.0	41	35.0	15	1572.32.210	25
M32x1.5	21.0	25.5	41	35.0	15	1572.32.255	25
M40x1.5	20.0	24.0	50	40.0	15	1572.40.240	10
M40x1.5	24.0	28.5	50	40.0	15	1572.40.285	10
M40x1.5	28.5	33.0	50	40.0	15	1572.40.330	10
M50x1.5	29.0	33.0	60	42.0	16	1572.50.330	10
M50x1.5	33.0	37.0	60	42.0	16	1572.50.370	10
M50x1.5	37.0	42.0	60	42.0	16	1572.50.420	10
M63x1.5	35.0	40.0	75	48.0	16	1572.63.400	5
M63x1.5	40.0	46.0	75	48.0	16	1572.63.460	5
M63x1.5	46.0	52.0	75	48.0	16	1572.63.520	5



Progress GFK



Dunkelgrau RAL 7001
Zweiteiliger Dichteinsatz

Dark grey RAL 7001
Two-piece sealing insert

G	> Ø <	> Ø <	> Ø <	> Ø <	⊕	H	L	Art.-No.	
	min mm	max mm	min mm	max mm	mm	mm	mm		
M16x1.5	6.0	8.0	8.0	10.5	21	26.0	12	1572.17	50
M20x1.5	8.0	11.0	11.0	15.0	27	28.0	13	1572.20	50
M25x1.5	12.5	16.0	16.0	20.5	34	33.0	13	1572.25	25
M32x1.5	17.0	21.0	21.0	25.5	41	35.0	15	1572.32	25
M40x1.5	24.0	28.5	28.5	33.0	50	40.0	15	1572.40	10
M50x1.5	33.0	37.0	37.0	42.0	60	42.0	16	1572.50	10
M63x1.5	40.0	46.0	46.0	52.0	75	48.0	16	1572.63	5



Progress GFK



Kabelverschraubungen Progress® Kunststoff GFK

Synthetic cable glands Progress® GFK

Anschlussgewinde metrisch | Entry thread metric

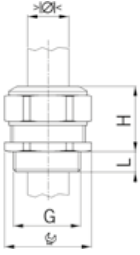

Material: Polyamid glasfaserverstärkt
 Eigenschaften: halogenfrei
 Dichtung: TPE
 Zugentlastung: Ausführung A nach EN 62444
 Schutzart: IP 68
 Einsatztemperatur: -20 °C / +100 °C

Material: Polyamide glass fiber reinforced
 Properties: halogen-free
 Seal: TPE
 Strain relief: Version A acc. to EN 62444
 Protection class: IP 68
 Operation temperature: -20 °C / +100 °C



Progress GFK



Schwarz RAL 9005
 Einteiliger Dichteinsatz

Black RAL 9005
 One-piece sealing insert

G	>Ø< min mm	>Ø< max mm	Ø mm	H mm	L mm	Art.-No.	
M8x1.0	2.5	3.5	12	15.5	10	1540.08.035	50
M8x1.0	3.5	5.0	12	15.5	10	1540.08.050	50
M10x1.0	3.0	4.0	15	18.0	10	1540.10.040	50
M10x1.0	4.0	6.0	15	18.0	10	1540.10.060	50
M12x1.5	3.5	5.0	17	22.0	12	1540.12.050	50
M12x1.5	5.0	6.5	17	22.0	12	1540.12.065	50
M12x1.5	6.5	8.0	17	22.0	12	1540.12.080	50
M16x1.5	4.5	6.0	21	26.0	12	1540.17.060	50
M16x1.5	6.0	8.0	21	26.0	12	1540.17.080	50
M16x1.5	8.0	10.5	21	26.0	12	1540.17.105	50
M20x1.5	6.0	8.0	27	28.0	13	1540.20.080	50
M20x1.5	8.0	11.0	27	28.0	13	1540.20.110	50
M20x1.5	11.0	15.0	27	28.0	13	1540.20.150	50
M25x1.5	9.5	12.5	34	33.0	13	1540.25.125	25
M25x1.5	12.5	16.0	34	33.0	13	1540.25.160	25
M25x1.5	16.0	20.5	34	33.0	13	1540.25.205	25
M32x1.5	14.0	17.0	41	35.0	15	1540.32.170	25
M32x1.5	17.0	21.0	41	35.0	15	1540.32.210	25
M32x1.5	21.0	25.5	41	35.0	15	1540.32.255	25
M40x1.5	20.0	24.0	50	40.0	15	1540.40.240	10
M40x1.5	24.0	28.5	50	40.0	15	1540.40.285	10
M40x1.5	28.5	33.0	50	40.0	15	1540.40.330	10
M50x1.5	29.0	33.0	60	42.0	16	1540.50.330	10
M50x1.5	33.0	37.0	60	42.0	16	1540.50.370	10
M50x1.5	37.0	42.0	60	42.0	16	1540.50.420	10
M63x1.5	35.0	40.0	75	48.0	16	1540.63.400	5
M63x1.5	40.0	46.0	75	48.0	16	1540.63.460	5
M63x1.5	46.0	52.0	75	48.0	16	1540.63.520	5



Progress GFK



Schwarz RAL 9005
 Zweiteiliger Dichteinsatz

Black RAL 9005
 Two-piece sealing insert

G	>Ø< min mm	>Ø< max mm	>Ø< min mm	>Ø< max mm	Ø mm	H mm	L mm	Art.-No.	
M16x1.5	6.0	8.0	8.0	10.5	21	26.0	12	1540.17	50
M20x1.5	8.0	11.0	11.0	15.0	27	28.0	13	1540.20	50
M25x1.5	12.5	16.0	16.0	20.5	34	33.0	13	1540.25	25
M32x1.5	17.0	21.0	21.0	25.5	41	35.0	15	1540.32	25
M40x1.5	24.0	28.5	28.5	33.0	50	40.0	15	1540.40	10
M50x1.5	33.0	37.0	37.0	42.0	60	42.0	16	1540.50	10
M63x1.5	40.0	46.0	46.0	52.0	75	48.0	16	1540.63	5

Anschlussgewinde metrisch | Entry thread metric

Material:	Polyamid glasfaserverstärkt	Material:	Polyamide glass fiber reinforced
Eigenschaften:	halogenfrei	Properties:	halogen-free
Dichtung:	TPE	Seal:	TPE
Zugentlastung:	Ausführung A nach EN 62444	Strain relief:	Version A acc. to EN 62444
Schutzart:	IP 68	Protection class:	IP 68
Einsatztemperatur:	-20 °C / +100 °C	Operation temperature:	-20 °C / +100 °C

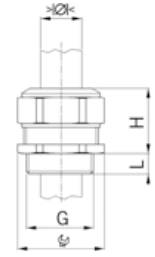

Weiss RAL 9010
Einteiliger Dichteinsatz

White RAL 9010
One-piece sealing insert

G	> Ø <	> Ø <	mm	H	L	Art.-No.	
	min mm	max mm	mm	mm	mm		
M20x1.5	6.0	8.0	27	28	13	1520.20.080	50
M20x1.5	8.0	11.0	27	28	13	1520.20.110	50



Progress GFK



Weiss RAL 9010
Zweiteiliger Dichteinsatz

White RAL 9010
Two-piece sealing insert

G	> Ø <	> Ø <	> Ø <	> Ø <	mm	H	L	Art.-No.	
	min mm	max mm	min mm	max mm	mm	mm	mm		
M16x1.5	6.0	8.0	8.0	10.5	21	26	12	1520.17	50
M20x1.5	8.0	11.0	11.0	15.0	27	28	13	1520.20	50
M25x1.5	12.5	16.0	16.0	20.5	34	33	13	1520.25	25



Progress GFK



Graugrün RAL 7009
Zweiteiliger Dichteinsatz

Greygreen RAL 7009
Two-piece sealing insert

G	> Ø <	> Ø <	> Ø <	> Ø <	mm	H	L	Art.-No.	
	min mm	max mm	min mm	max mm	mm	mm	mm		
M16x1.5	6.0	8.0	8.0	10.5	21	26	12	1570.17	50
M20x1.5	8.0	11.0	11.0	15.0	27	28	13	1570.20	50
M25x1.5	12.5	16.0	16.0	20.5	34	33	13	1570.25	25
M32x1.5	17.0	21.0	21.0	25.5	41	35	15	1570.32	25



Progress GFK



1
2
3
4
5
6
7
8
9
10
11
12
13
14
15

Anschlussgewinde Pg | Entry thread Pg

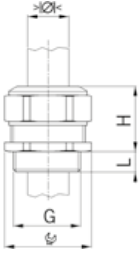

Material: Polyamid glasfaserverstärkt
 Eigenschaften: halogenfrei
 Dichtung: TPE
 Schutzart: IP 68
 Einsatztemperatur: -20 °C / +100 °C

Material: Polyamide glass fiber reinforced
 Properties: halogen-free
 Seal: TPE
 Protection class: IP 68
 Operation temperature: -20 °C / +100 °C



Hellgrau RAL 7035
 Einteiliger Dichteinsatz

Light grey RAL 7035
 One-piece sealing insert

G	$\begin{matrix} > \text{Ø} < \\ \text{min mm} \end{matrix}$	$\begin{matrix} > \text{Ø} < \\ \text{max mm} \end{matrix}$	$\begin{matrix} \text{H} \\ \text{mm} \end{matrix}$	$\begin{matrix} \text{L} \\ \text{mm} \end{matrix}$	Art.-No.	
Pg 7	3.5	5.0	17	22	1571.07.050	50
Pg 7	5.0	6.5	17	22	1571.07.065	50
Pg 7	6.5	8.0	17	22	1571.07.080	50
Pg 9	4.5	6.0	21	26	1571.09.060	50
Pg 9	6.0	8.0	21	26	1571.09.080	50
Pg 9	8.0	10.5	21	26	1571.09.105	50
Pg 11	4.0	5.5	24	28	1571.11.055	50
Pg 11	5.5	8.5	24	28	1571.11.085	50
Pg 11	8.5	12.0	24	28	1571.11.120	50
Pg 13	6.0	8.0	27	28	1571.13.080	50
Pg 13	8.0	11.0	27	28	1571.13.110	50
Pg 13	11.0	15.0	27	28	1571.13.150	50
Pg 16	6.0	8.0	27	28	1571.16.080	50
Pg 16	8.0	11.0	27	28	1571.16.110	50
Pg 16	11.0	15.0	27	28	1571.16.150	50
Pg 21	9.5	12.5	34	33	1571.21.125	25
Pg 21	12.5	16.0	34	33	1571.21.160	25
Pg 21	16.0	20.5	34	33	1571.21.205	25
Pg 29	16.0	19.0	41	36	1571.29.190	25
Pg 29	19.0	23.0	41	36	1571.29.230	25
Pg 29	23.0	27.5	41	36	1571.29.275	25
Pg 36	21.5	26.0	55	42	1571.36.260	10
Pg 36	26.0	30.5	55	42	1571.36.305	10
Pg 36	30.5	35.0	55	42	1571.36.350	10
Pg 42	29.0	33.0	60	42	1571.42.330	10
Pg 42	33.0	37.0	60	42	1571.42.370	10
Pg 42	37.0	42.0	60	42	1571.42.420	10
Pg 48	32.0	37.0	70	46	1571.48.370	5
Pg 48	37.0	43.0	70	46	1571.48.430	5
Pg 48	43.0	49.0	70	46	1571.48.490	5



Hellgrau RAL 7035
 Zweiteiliger Dichteinsatz

Light grey RAL 7035
 Two-piece sealing insert

G	$\begin{matrix} > \text{Ø} < \\ \text{min mm} \end{matrix}$	$\begin{matrix} > \text{Ø} < \\ \text{max mm} \end{matrix}$	$\begin{matrix} > \text{Ø} < \\ \text{min mm} \end{matrix}$	$\begin{matrix} > \text{Ø} < \\ \text{max mm} \end{matrix}$	$\begin{matrix} \text{H} \\ \text{mm} \end{matrix}$	$\begin{matrix} \text{L} \\ \text{mm} \end{matrix}$	Art.-No.	
Pg 9	6.0	8.0	8.0	10.5	21	26	1571.09	50
Pg 11	5.5	8.5	8.5	12.0	24	28	1571.11	50
Pg 13	8.0	11.0	11.0	15.0	27	28	1571.13	50
Pg 16	8.0	11.0	11.0	15.0	27	28	1571.16	50
Pg 21	12.5	16.0	16.0	20.5	34	33	1571.21	25
Pg 29	19.0	23.0	23.0	27.5	41	36	1571.29	25
Pg 36	26.0	30.5	30.5	35.0	55	42	1571.36	10
Pg 42	33.0	37.0	37.0	42.0	60	42	1571.42	10
Pg 48	37.0	43.0	43.0	49.0	70	46	1571.48	5

Kabelverschraubungen Progress® Kunststoff GFK für mehrere Kabel Synthetic cable glands Progress® GFK for installation of multiple cables

Anschlussgewinde Pg | Entry thread Pg

Material: Polyamid glasfaserverstärkt
Eigenschaften: halogenfrei
Dichtung: TPE
Schutzart: IP 68
Einsatztemperatur: -20 °C / +100 °C

Material: Polyamide glass fiber reinforced
Properties: halogen-free
Seal: TPE
Protection class: IP 68
Operation temperature: -20 °C / +100 °C

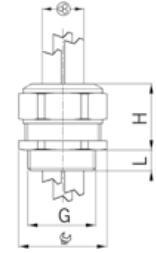

Hellgrau RAL 7035
Einteiliger Dichteinsatz

Light grey RAL 7035
One-piece sealing insert

G **H** **L**
min mm max mm mm mm mm mm

	G			H	L	Art.-No.	
	min mm	max mm		mm	mm		
Pg 9	2.0	3.0	2	21	26	1571.09.2.030	50
Pg 9	2.5	4.0	2	21	26	1571.09.2.040	50
Pg 9	3.5	5.0	2	21	26	1571.09.2.050	50
Pg 11	3.5	5.0	2	24	28	1571.11.2.050	50
Pg 11	4.5	6.0	2	24	28	1571.11.2.060	50
Pg 11	3.5	5.0	3	24	28	1571.11.3.050	50
Pg 13	3.5	5.0	2	27	28	1571.13.2.050	50
Pg 13	4.5	6.0	2	27	28	1571.13.2.060	50
Pg 13	5.5	7.5	2	27	28	1571.13.2.075	50
Pg 13	3.5	5.0	3	27	28	1571.13.3.050	50
Pg 13	4.5	6.0	3	27	28	1571.13.3.060	50
Pg 13	5.2	6.5	3	27	28	1571.13.3.065	50
Pg 13	3.5	5.0	4	27	28	1571.13.4.050	50
Pg 13	4.5	6.0	4	27	28	1571.13.4.060	50
Pg 16	3.5	5.0	2	27	28	1571.16.2.050	50
Pg 16	4.5	6.0	2	27	28	1571.16.2.060	50
Pg 16	5.5	7.5	2	27	28	1571.16.2.075	50
Pg 16	3.5	5.0	3	27	28	1571.16.3.050	50
Pg 16	4.5	6.0	3	27	28	1571.16.3.060	50
Pg 16	5.2	6.5	3	27	28	1571.16.3.065	50
Pg 16	3.5	5.0	4	27	28	1571.16.4.050	50
Pg 16	4.5	6.0	4	27	28	1571.16.4.060	50
Pg 21	5.0	7.0	2	34	33	1571.21.2.070	25
Pg 21	6.7	9.0	2	34	33	1571.21.2.090	25
Pg 21	7.7	10.0	2	34	33	1571.21.2.100	25
Pg 21	5.5	7.0	3	34	33	1571.21.3.070	25
Pg 21	6.8	9.0	3	34	33	1571.21.3.090	25
Pg 21	5.5	7.0	4	34	33	1571.21.4.070	25
Pg 21	4.8	6.0	6	34	33	1571.21.6.060	25
Pg 29	7.5	9.0	3	41	36	1571.29.3.090	25

Weitere Ausführungen und Farben auf Anfrage: z.B. dunkelgrau RAL 7001, schwarz RAL 9005, grössere Anschlussgewinde

Additional versions and colours are available upon request: e.g. dark grey RAL 7001, black RAL 9005, larger entry threads



Kabelverschraubungen Progress® Kunststoff GFK

Synthetic cable glands Progress® GFK

Anschlussgewinde Pg | Entry thread Pg

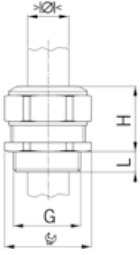

Material: Agromid glasfaserverstärkt, wärmealterungs- und schlagzäh modifiziert

Eigenschaften: halogenfrei

Dichtung: TPE

Schutzart: IP 68

Einsatztemperatur: -30 °C / +100 °C

Material: Agromid glass fiber reinforced, heat aging and impact-resistant modified

Properties: halogen-free

Seal: TPE

Protection class: IP 68

Operation temperature: -30 °C / +100 °C



Dunkelgrau RAL 7001
Einteiliger Dichteinsatz

Dark grey RAL 7001
One-piece sealing insert

G	$\begin{matrix} > \text{Ø} < \\ \text{min mm} \end{matrix}$	$\begin{matrix} > \text{Ø} < \\ \text{max mm} \end{matrix}$	$\begin{matrix} \text{H} \\ \text{mm} \end{matrix}$	$\begin{matrix} \text{L} \\ \text{mm} \end{matrix}$	Art.-No.	
Pg 7	3.5	5.0	17	22	1572.07.050	50
Pg 7	5.0	6.5	17	22	1572.07.065	50
Pg 7	6.5	8.0	17	22	1572.07.080	50
Pg 9	4.5	6.0	21	26	1572.09.060	50
Pg 9	6.0	8.0	21	26	1572.09.080	50
Pg 9	8.0	10.5	21	26	1572.09.105	50
Pg 11	4.0	5.5	24	28	1572.11.055	50
Pg 11	5.5	8.5	24	28	1572.11.085	50
Pg 11	8.5	12.0	24	28	1572.11.120	50
Pg 13	6.0	8.0	27	28	1572.13.080	50
Pg 13	8.0	11.0	27	28	1572.13.110	50
Pg 13	11.0	15.0	27	28	1572.13.150	50
Pg 16	6.0	8.0	27	28	1572.16.080	50
Pg 16	8.0	11.0	27	28	1572.16.110	50
Pg 16	11.0	15.0	27	28	1572.16.150	50
Pg 21	9.5	12.5	34	33	1572.21.125	25
Pg 21	12.5	16.0	34	33	1572.21.160	25
Pg 21	16.0	20.5	34	33	1572.21.205	25
Pg 29	16.0	19.0	41	36	1572.29.190	25
Pg 29	19.0	23.0	41	36	1572.29.230	25
Pg 29	23.0	27.5	41	36	1572.29.275	25
Pg 36	21.5	26.0	55	42	1572.36.260	10
Pg 36	26.0	30.5	55	42	1572.36.305	10
Pg 36	30.5	35.0	55	42	1572.36.350	10
Pg 42	29.0	33.0	60	42	1572.42.330	10
Pg 42	33.0	37.0	60	42	1572.42.370	10
Pg 42	37.0	42.0	60	42	1572.42.420	10
Pg 48	32.0	37.0	70	46	1572.48.370	5
Pg 48	37.0	43.0	70	46	1572.48.430	5
Pg 48	43.0	49.0	70	46	1572.48.490	5



Dunkelgrau RAL 7001
Zweiteiliger Dichteinsatz

Dark grey RAL 7001
Two-piece sealing insert

G	$\begin{matrix} > \text{Ø} < \\ \text{min mm} \end{matrix}$	$\begin{matrix} > \text{Ø} < \\ \text{max mm} \end{matrix}$	$\begin{matrix} > \text{Ø} < \\ \text{min mm} \end{matrix}$	$\begin{matrix} > \text{Ø} < \\ \text{max mm} \end{matrix}$	$\begin{matrix} \text{H} \\ \text{mm} \end{matrix}$	$\begin{matrix} \text{L} \\ \text{mm} \end{matrix}$	Art.-No.	
Pg 9	6.0	8.0	8.0	10.5	21	26	1572.09	50
Pg 11	5.5	8.5	8.5	12.0	24	28	1572.11	50
Pg 13	8.0	11.0	11.0	15.0	27	28	1572.13	50
Pg 16	8.0	11.0	11.0	15.0	27	28	1572.16	50
Pg 21	12.5	16.0	16.0	20.5	34	33	1572.21	25
Pg 29	19.0	23.0	23.0	27.5	41	36	1572.29	25
Pg 36	26.0	30.5	30.5	35.0	55	42	1572.36	10
Pg 42	33.0	37.0	37.0	42.0	60	42	1572.42	10
Pg 48	37.0	43.0	43.0	49.0	70	46	1572.48	5

Anschlussgewinde Pg | Entry thread Pg

Material: Polyamid glasfaserverstärkt
 Eigenschaften: halogenfrei
 Dichtung: TPE
 Schutzart: IP 68
 Einsatztemperatur: -20 °C / +100 °C

Material: Polyamide glass fiber reinforced
 Properties: halogen-free
 Seal: TPE
 Protection class: IP 68
 Operation temperature: -20 °C / +100 °C

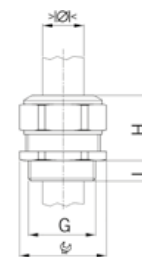

Schwarz RAL 9005
 Einteiliger Dichteinsatz

Black RAL 9005
 One-piece sealing insert

G	> < <	> < <	mm	H	L	Art.-No.	
	min mm	max mm	mm	mm	mm		
Pg 7	3.5	5.0	17	22	12	1540.07.050	50
Pg 7	5.0	6.5	17	22	12	1540.07.065	50
Pg 7	6.5	8.0	17	22	12	1540.07.080	50
Pg 9	4.5	6.0	21	26	12	1540.09.060	50
Pg 9	6.0	8.0	21	26	12	1540.09.080	50
Pg 9	8.0	10.5	21	26	12	1540.09.105	50
Pg 11	4.0	5.5	24	28	12	1540.11.055	50
Pg 11	5.5	8.5	24	28	12	1540.11.085	50
Pg 11	8.5	12.0	24	28	12	1540.11.120	50
Pg 13	6.0	8.0	27	28	13	1540.13.080	50
Pg 13	8.0	11.0	27	28	13	1540.13.110	50
Pg 13	11.0	15.0	27	28	13	1540.13.150	50
Pg 16	6.0	8.0	27	28	13	1540.16.080	50
Pg 16	8.0	11.0	27	28	13	1540.16.110	50
Pg 16	11.0	15.0	27	28	13	1540.16.150	50
Pg 21	9.5	12.5	34	33	13	1540.21.125	25
Pg 21	12.5	16.0	34	33	13	1540.21.160	25
Pg 21	16.0	20.5	34	33	13	1540.21.205	25
Pg 29	16.0	19.0	41	36	13	1540.29.190	25
Pg 29	19.0	23.0	41	36	13	1540.29.230	25
Pg 29	23.0	27.5	41	36	13	1540.29.275	25
Pg 36	21.5	26.0	55	42	16	1540.36.260	10
Pg 36	26.0	30.5	55	42	16	1540.36.305	10
Pg 36	30.5	35.0	55	42	16	1540.36.350	10
Pg 42	29.0	33.0	60	42	16	1540.42.330	10
Pg 42	33.0	37.0	60	42	16	1540.42.370	10
Pg 42	37.0	42.0	60	42	16	1540.42.420	10
Pg 48	32.0	37.0	70	46	16	1540.48.370	5
Pg 48	37.0	43.0	70	46	16	1540.48.430	5
Pg 48	43.0	49.0	70	46	16	1540.48.490	5



Schwarz RAL 9005
 Zweiteiliger Dichteinsatz

Black RAL 9005
 Two-piece sealing insert

G	> < <	> < <	> < <	> < <	mm	H	L	Art.-No.	
	min mm	max mm	min mm	max mm	mm	mm	mm		
Pg 9	6.0	8.0	8.0	10.5	21	26	12	1540.09	50
Pg 11	5.5	8.5	8.5	12.0	24	28	12	1540.11	50
Pg 13	8.0	11.0	11.0	15.0	27	28	13	1540.13	50
Pg 16	8.0	11.0	11.0	15.0	27	28	13	1540.16	50
Pg 21	12.5	16.0	16.0	20.5	34	33	13	1540.21	25
Pg 29	19.0	23.0	23.0	27.5	41	36	13	1540.29	25
Pg 36	26.0	30.5	30.5	35.0	55	42	16	1540.36	10
Pg 42	33.0	37.0	37.0	42.0	60	42	16	1540.42	10
Pg 48	37.0	43.0	43.0	49.0	70	46	16	1540.48	5



Kabelverschraubungen Syntec® Messing und Kunststoff

Cable glands Syntec® nickel-plated brass and synthetic

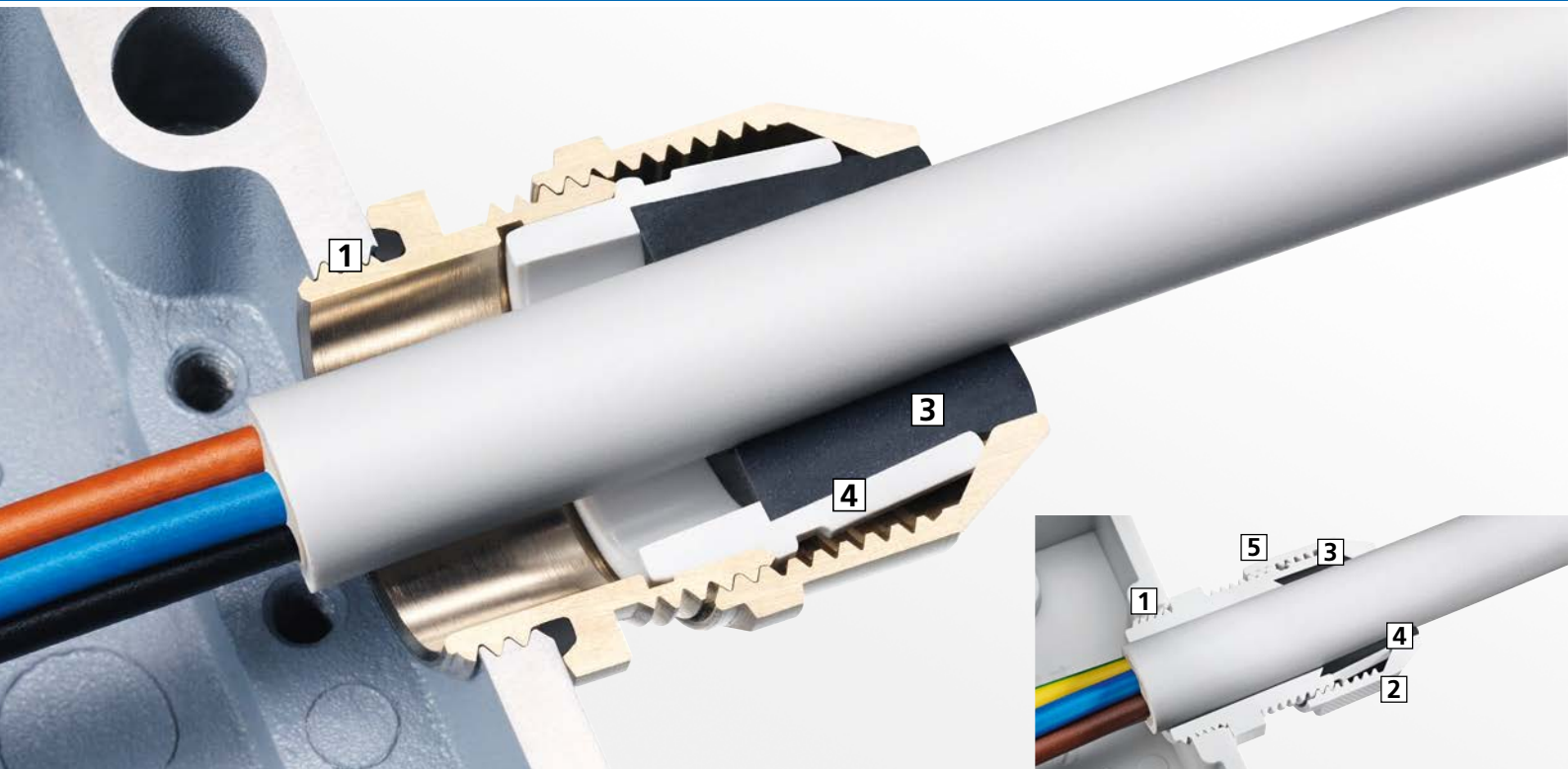

Kabelverschraubungen Syntec® Messing und Kunststoff mit innovativer Lamellentechnik. Die beweglichen Gelenklamellen ermöglichen grosse Klemm- und Dichtbereiche für den flexiblen und sicheren täglichen Einsatz. Die Vorfixierung der Kunststoff-Druckmutter erleichtert Überkopf-Montagen sehr.

1 Kurzes oder langes Gewinde

Qualitätsverschraubungen mit kurzem oder langem metrischen Gewinde für die sichere Befestigung mit Gewinde oder Gegenmutter.

2 Hörbare Sicherheit in Kunststoff

Die Rastnocken der Druckmutter garantieren mit hörbarem „Klick“ immer den vibrations- und rüttelfesten Halt des Kabels.

3 Garantierte Dichtigkeit

Die elastischen, umweltbeständigen Dichtringe halten sicher dicht, sind besonders langlebig und garantieren die Schutzart IP 68.

4 Einzigartige Lamellentechnik

Die von AGRO entwickelte Lamellengeometrie mit beweglichen Gelenklamellen ermöglicht das Einführen verschiedener Durchmesser in die Syntec® Kabelverschraubung bei hervorragender Zugentlastung und exzellentem Verdrehenschutz.

5 Grosse Schlüsselflächen in Kunststoff

Der grossflächige Sechskant der Druckmutter bietet immer sicheren und festen Halt beim Festziehen von Hand oder mit dem Werkzeug.

AGRO Cable glands Syntec® nickel-plated brass and synthetic material with innovative lamellar technology. The flexible “lamellas” of the segmental ring clamp the cable right around, providing great flexibility in terms of clamping and sealing and thus ensuring reliability and convenience. The pre-assembly of the plastic compression nut simplifies overhead installation.

1 Short or long thread

Quality cable glands with a short or long metric thread for secure connection to a threaded hole or using a counter nut.

2 Audible confirmation with the plastic version

The design of the compression nut causes an audible “click” that ensures a vibration- and shake-proof grip.

3 Ensured leak-tightness

The elastic sealing rings provide a reliable seal, are particularly durable and resistant to environmental influences and.

4 Unique lamellar technology

The AGRO-developed design facilitates the insertion of cables of different diameters into the Syntec® cable gland and ensures outstanding strain relief and anti-rotation protection.

5 Large spanner flats on the synthetic version

The large hexagonal surface of the compression nuts ensures consistently reliable and secure grip when tightened by hand or using a spanner.

Trapezförmige Gelenklamellen



Die einzigartige Lamellentechnik garantiert eine hervorragende Zugentlastung.

Die trapezförmigen Lamellen gleiten beim Anziehen der Kabelverschraubung ineinander und verpressen das Kabel verdrehsicher in ein Sechseck.

Trapezoidal lamellas



The unique lamellar technology ensures excellent strain relief.

When the compression nut of the cable gland is tightened, the single lamellas come together to form a hexagon, clamping the cable tightly and preventing cable rotation.



Kabelverschraubungen Syntec® Messing mit Lamellentechnik Cable glands Syntec® nickel-plated brass with lamellar technology		224
Kabelverschraubungen Syntec® Kunststoff mit Lamellentechnik Synthetic cable glands Syntec® with lamellar technology		225 - 228
Kabelverschraubungen Syntec® Kunststoff mit Lamellentechnik und Knickschutz Synthetic cable glands Syntec® with lamellar technology and anti-kink nozzle		229 - 232

Ausführung / Design	Syntec® Kunststoff Syntec® synthetic	Standard Standard	Mit Knickschutz With antikink protection	Syntec® Messing Syntec® nickel-plated brass	Standard Standard
Lamellentechnik Lamellar technology		•	•		•
Gewinde / Thread					
Anschlussgewinde Pg Entry thread Pg		•	•		A
Anschlussgewinde NPT Entry thread NPT		•	•		-
Kurzes Anschlussgewinde metrisch Short entry thread metric		•	•		•
Langes Anschlussgewinde metrisch Long entry thread metric		•	•		•
Dichteinsatz / Sealing insert					
Für Rundkabel For round cables		•	•		•
Standard Dichtring (TPE/CR) Standard sealing ring (TPE/CR)		•	•		•
Technische Besonderheiten / Technical features					
Erhöhter Vibrationsschutz Increased vibration resistance		•	•		-
Knickschutz Antikink protection		-	•		-
Farben / Colours					
Hellgrau RAL 7035 Light grey RL 7035		•	•		-
Dunkelgrau RAL 7001 Dark grey RAL 7001		A	A		-
Schwarz RAL 9005 Black RAL 9005		•	•		-
Messing vernickelt Nickel-plated brass		-	-		•

A = auf Anfrage / upon request

1
2
3
4
5
6
7
8
9
10
11
12
13
14
15

Kabelverschraubungen Syntec® Messing mit Lamellentechnik

Cable glands Syntec® nickel-plated brass with lamellar technology

Kurzes Anschlussgewinde metrisch | Short entry thread metric



Material: Messing vernickelt
 Dichtring: TPE
 O-Ring: NBR
 Lamelleneinsatz: Polyamid PA 6
 Zugentlastung: Ausführung A nach EN 62444
 Schutzart: IP 68
 NEMA Type rating: 4X
 Einsatztemperatur: -40 °C / +100 °C

Material: Nickel-plated brass
 Sealing ring: TPE
 O-ring: NBR
 Lamellar insert: Polyamide PA 6
 Strain relief: Version A acc. to EN 62444
 Protection class: IP 68
 NEMA Type rating: 4X
 Operation temperature: -40 °C / +100 °C



SYNTEC MS



Einteiliger Dichtring
nicht durchgehend isolierend

One-piece sealing ring
not overall length insulated

G	$\begin{matrix} > \text{Ø} < \\ \text{min mm} \end{matrix}$	$\begin{matrix} > \text{Ø} < \\ \text{max mm} \end{matrix}$	$\begin{matrix} \text{mm} \\ \text{mm} \end{matrix}$	H mm	L mm	Art.-No.	
M12x1.5	1.0	5.0	15	17	5	1045.12.050	50
M12x1.5	3.0	7.0	15	17	5	1045.12.070	50
M16x1.5	2.0	6.0	18	20	5	1045.17.060	50
M16x1.5	4.5	10.0	18	20	5	1045.17.100	50
M20x1.5	3.5	8.0	22	25	6	1045.20.080	50
M20x1.5	7.0	13.0	22	25	6	1045.20.130	50
M25x1.5	5.0	11.0	28	31	7	1045.25.110	25
M25x1.5	10.0	17.0	28	31	7	1045.25.170	25
M32x1.5	7.0	15.0	36	33	8	1045.32.150	25
M32x1.5	13.0	21.0	36	33	8	1045.32.210	25
M40x1.5	15.0	23.0	46	40	8	1045.40.230	10
M40x1.5	19.0	28.0	46	40	8	1045.40.280	10
M50x1.5	20.0	29.0	55	40	9	1045.50.290	5
M50x1.5	25.0	35.0	55	40	9	1045.50.350	5
M63x1.5	28.0	39.0	70	43	10	1045.63.390	5
M63x1.5	35.0	48.0	70	43	10	1045.63.480	5

Auf Anfrage lieferbar:
Anschlussgewinde Pg

Available on request:
Entry thread Pg

Langes Anschlussgewinde metrisch | Long entry thread metric



SYNTEC MS



Einteiliger Dichtring
nicht durchgehend isolierend

One-piece sealing ring
not overall length insulated

G	$\begin{matrix} > \text{Ø} < \\ \text{min mm} \end{matrix}$	$\begin{matrix} > \text{Ø} < \\ \text{max mm} \end{matrix}$	$\begin{matrix} \text{mm} \\ \text{mm} \end{matrix}$	H mm	L mm	Art.-No.	
M12x1.5	1.0	5.0	15	17	12	1145.12.050	50
M12x1.5	3.0	7.0	15	17	12	1145.12.070	50
M16x1.5	2.0	6.0	18	20	12	1145.17.060	50
M16x1.5	4.5	10.0	18	20	12	1145.17.100	50
M20x1.5	3.5	8.0	22	25	12	1145.20.080	50
M20x1.5	7.0	13.0	22	25	12	1145.20.130	50
M25x1.5	5.0	11.0	28	31	12	1145.25.110	25
M25x1.5	10.0	17.0	28	31	12	1145.25.170	25
M32x1.5	7.0	15.0	36	33	15	1145.32.150	25
M32x1.5	13.0	21.0	36	33	15	1145.32.210	25
M40x1.5	15.0	23.0	46	40	15	1145.40.230	10
M40x1.5	19.0	28.0	46	40	15	1145.40.280	10
M50x1.5	20.0	29.0	55	40	15	1145.50.290	5
M50x1.5	25.0	35.0	55	40	15	1145.50.350	5
M63x1.5	28.0	39.0	70	43	15	1145.63.390	5
M63x1.5	35.0	48.0	70	43	15	1145.63.480	5
M63x1.5	44.0	55.0	80	43	15	1145.63.550	5

Kabelverschraubungen Syntec® Kunststoff mit Lamellentechneik

Synthetic cable glands Syntec® with lamellar technology

Kurzes Anschlussgewinde metrisch | Short entry thread metric

Material: Polyamid PA 6
 Eigenschaften: halogenfrei, schwarz UV beständig (getestet nach EN ISO 4892-2)
 Dichtring: TPE oder CR (Neopren)
 Zugentlastung: Ausführung A nach EN 62444
 Schutzart: IP 68
 NEMA Type rating: 4X
 Einsatztemperatur: -30 °C / +100 °C

Material: Polyamide PA 6
 Properties: halogen-free, black UV resistant (tested according to EN ISO 4892-2)
 Sealing ring: TPE or CR (Neoprene)
 Strain relief: Version A acc. to EN 62444
 Protection class: IP 68
 NEMA Type rating: 4X
 Operation temperature: -30 °C / +100 °C



Hellgrau RAL 7035
 Einteiliger Dichtring

Light grey RAL 7035
 One-piece sealing ring

G	>Ø< min mm	>Ø< max mm	H mm	L mm	Art.-No.	
M12x1.5	2.5	6.5	15	21	1555.12.06	100
M16x1.5	2.0	6.0	19	25	1555.17.06	50
M16x1.5	5.0	10.0	19	25	1555.17.10	50
M20x1.5	3.5	8.0	24	29	1555.20.08	50
M20x1.5	7.0	13.0	24	29	1555.20.13	50
M25x1.5	5.0	11.0	29	38	1555.25.11	25
M25x1.5	10.0	17.0	29	38	1555.25.17	25
M32x1.5	17.0	25.0	42	36	1555.32.25	20

Auf Anfrage lieferbar:

Available on request:

Dunkelgrau RAL 7001

Dark grey RAL 7001



SYNTEC



Schwarz RAL 9005
 Einteiliger Dichtring

Black RAL 9005
 One-piece sealing ring

G	>Ø< min mm	>Ø< max mm	H mm	L mm	Art.-No.	
M12x1.5	2.5	6.5	15	21	1545.12.06	100
M16x1.5	2.0	6.0	19	25	1545.17.06	50
M16x1.5	5.0	10.0	19	25	1545.17.10	50
M20x1.5	3.5	8.0	24	29	1545.20.08	50
M20x1.5	7.0	13.0	24	29	1545.20.13	50
M25x1.5	5.0	11.0	29	38	1545.25.11	25
M25x1.5	10.0	17.0	29	38	1545.25.17	25
M32x1.5	17.0	25.0	42	36	1545.32.25	20



SYNTEC



Kabelverschraubungen Syntec® Kunststoff mit Lamellentechnik

Synthetic cable glands Syntec® with lamellar technology

Langes Anschlussgewinde metrisch | Long entry thread metric

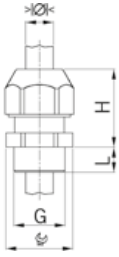

Material: Polyamid PA 6
 Eigenschaften: halogenfrei, schwarz UV beständig (getestet nach EN ISO 4892-2)
 Dichtring: TPE oder CR (Neopren)
 Zugentlastung: Ausführung A nach EN 62444
 Schutzart: IP 68
 NEMA Type rating: 4X
 Einsatztemperatur: -30 °C / +100 °C

Material: Polyamide PA 6
 Properties: halogen-free, black UV resistant (tested according to EN ISO 4892-2)
 Sealing ring: TPE or CR (Neoprene)
 Strain relief: Version A acc. to EN 62444
 Protection class: IP 68
 NEMA Type rating: 4X
 Operation temperature: -30 °C / +100 °C



SYNTEC



Hellgrau RAL 7035
 Einteiliger Dichtring

Light grey RAL 7035
 One-piece sealing ring

G	>Ø< min mm	>Ø< max mm	mm	H mm	L mm	Art.-No.	
M12x1.5	2.5	6.5	15	21	12	1555.12.1.06	100
M16x1.5	2.0	6.0	19	25	15	1555.17.1.06	50
M16x1.5	5.0	10.0	19	25	15	1555.17.1.10	50
M20x1.5	3.5	8.0	24	29	15	1555.20.1.08	50
M20x1.5	7.0	13.0	24	29	15	1555.20.1.13	50
M25x1.5	5.0	11.0	29	38	15	1555.25.1.11	25
M25x1.5	10.0	17.0	29	38	15	1555.25.1.17	25
M32x1.5	17.0	25.0	42	36	15	1555.32.1.25	20
M40x1.5	22.0	33.0	53	48	15	1555.40.1.33	10
M50x1.5	28.0	38.0	60	48	15	1555.50.1.38	5
M63x1.5	32.0	44.0	65	49	16	1555.63.1.44	5

Auf Anfrage lieferbar:
 Dunkelgrau RAL 7001

Available on request:
 Dark grey RAL 7001



SYNTEC



Schwarz RAL 9005
 Einteiliger Dichtring

Black RAL 9005
 One-piece sealing ring

G	>Ø< min mm	>Ø< max mm	mm	H mm	L mm	Art.-No.	
M12x1.5	2.5	6.5	15	21	12	1545.12.1.06	100
M16x1.5	2.0	6.0	19	25	15	1545.17.1.06	50
M16x1.5	5.0	10.0	19	25	15	1545.17.1.10	50
M20x1.5	3.5	8.0	24	29	15	1545.20.1.08	50
M20x1.5	7.0	13.0	24	29	15	1545.20.1.13	50
M25x1.5	5.0	11.0	29	38	15	1545.25.1.11	25
M25x1.5	10.0	17.0	29	38	15	1545.25.1.17	25
M32x1.5	17.0	25.0	42	36	15	1545.32.1.25	20
M40x1.5	22.0	33.0	53	48	15	1545.40.1.33	10
M50x1.5	28.0	38.0	60	48	15	1545.50.1.38	5
M63x1.5	32.0	44.0	65	49	16	1545.63.1.44	5

Kabelverschraubungen Syntec® Kunststoff mit Lamellentechnik Synthetic cable glands Syntec® with lamellar technology

Anschlussgewinde Pg | Entry thread Pg

Material: Polyamid PA 6
Eigenschaften: halogenfrei, schwarz UV beständig (getestet nach EN ISO 4892-2)
Dichtring: CR (Neopren)
Schutzart: IP 68
NEMA Type rating: 4X
Einsatztemperatur: -30 °C / +100 °C

Material: Polyamide PA 6
Properties: halogen-free, black UV resistant (tested according to EN ISO 4892-2)
Sealing ring: CR (neoprene)
Protection class: IP 68
NEMA Type rating: 4X
Operation temperature: -30 °C / +100 °C



Hellgrau RAL 7035
Einteiliger Dichtring

Light grey RAL 7035
One-piece sealing ring

G	>Ø< min mm	>Ø< max mm	mm	H mm	L mm	Art.-No.	
Pg 7	2.5	6.5	15	21	8	1555.07.06	100
Pg 9	3.0	8.0	19	23	8	1555.09.08	50
Pg 11	2.0	7.0	22	25	8	1555.11.07	50
Pg 11	4.0	10.0	22	25	8	1555.11.10	50
Pg 13	3.0	7.0	24	26	9	1555.13.07	50
Pg 13	5.5	12.0	24	26	9	1555.13.12	50
Pg 16	5.0	11.0	27	30	10	1555.16.11	50
Pg 16	8.5	14.0	27	30	10	1555.16.14	50
Pg 21	6.5	14.0	33	35	11	1555.21.14	25
Pg 21	11.0	18.0	33	35	11	1555.21.18	25
Pg 29	17.0	25.0	42	36	11	1555.29.25	20
Pg 36	22.0	33.0	53	48	15	1555.36.33	10
Pg 42	28.0	38.0	60	48	15	1555.42.38	5
Pg 48	32.0	44.0	65	48	15	1555.48.44	5



SYNTEC



Schwarz RAL 9005
Einteiliger Dichtring

Black RAL 9005
One-piece sealing ring

G	>Ø< min mm	>Ø< max mm	mm	H mm	L mm	Art.-No.	
Pg 7	2.5	6.5	15	21	8	1545.07.06	100
Pg 9	3.0	8.0	19	23	8	1545.09.08	50
Pg 11	2.0	7.0	22	25	8	1545.11.07	50
Pg 11	4.0	10.0	22	25	8	1545.11.10	50
Pg 13	3.0	7.0	24	26	9	1545.13.07	50
Pg 13	5.5	12.0	24	26	9	1545.13.12	50
Pg 16	5.0	11.0	27	30	10	1545.16.11	50
Pg 16	8.5	14.0	27	30	10	1545.16.14	50
Pg 21	6.5	14.0	33	35	11	1545.21.14	25
Pg 21	11.0	18.0	33	35	11	1545.21.18	25
Pg 29	17.0	25.0	42	36	11	1545.29.25	20
Pg 36	22.0	33.0	53	48	15	1545.36.33	10
Pg 42	28.0	38.0	60	48	15	1545.42.38	5
Pg 48	32.0	44.0	65	48	15	1545.48.44	5



SYNTEC



Kabelverschraubungen Syntec® Kunststoff mit Lamellentechnik

Synthetic cable glands Syntec® with lamellar technology

Anschlussgewinde NPT | Entry thread NPT

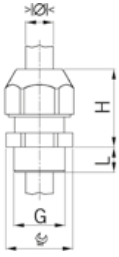

Material: Polyamid PA 6
 Eigenschaften: halogenfrei, schwarz UV beständig (getestet nach EN ISO 4892-2)
 Dichtring: CR (Neopren)
 Schutzart: IP 54
 Gewinde: IP 68, wenn Anschlussgewinde abgedichtet
 NEMA Type rating: 4X
 Einsatztemperatur: -30 °C / +100 °C

Material: Polyamide PA 6
 Properties: halogen-free, black UV resistant (tested according to EN ISO 4892-2)
 Sealing ring: CR (neoprene)
 Protection class: IP 54
 Entry thread: IP 68, if the entry thread is sealed
 NEMA Type rating: 4X
 Operation temperature: -30 °C / +100 °C



SYNTEC



Hellgrau RAL 7035
 Einteiliger Dichtring

Light grey RAL 7035
 One-piece sealing ring

G	>Ø< min mm	>Ø< max mm	mm	H mm	L mm	Art.-No.	
NPT 3/8"	3.0	8.0	19/22	23	15	1555.N0375.08	50
NPT 1/2"	3.0	7.0	24	26	15	1555.N0500.07	50
NPT 1/2"	5.5	12.0	24	26	15	1555.N0500.12	50
NPT 3/4"	6.5	14.0	33	35	15	1555.N0750.14	25
NPT 3/4"	11.0	18.0	33	35	15	1555.N0750.18	25
NPT 1"	17.0	22.0	42	36	15	1555.N1000.22	20



SYNTEC



Schwarz RAL 9005
 Einteiliger Dichtring

Black RAL 9005
 One-piece sealing ring

G	>Ø< min mm	>Ø< max mm	mm	H mm	L mm	Art.-No.	
NPT 3/8"	3.0	8.0	19/22	23	15	1545.N0375.08	50
NPT 1/2"	3.0	7.0	24	26	15	1545.N0500.07	50
NPT 1/2"	5.5	12.0	24	26	15	1545.N0500.12	50
NPT 3/4"	6.5	14.0	33	35	15	1545.N0750.14	25
NPT 3/4"	11.0	18.0	33	35	15	1545.N0750.18	25
NPT 1"	17.0	22.0	42	36	15	1545.N1000.22	20

Kabelverschraubungen Syntec® Kunststoff mit Lamellentechnik und Knickschutz Synthetic Syntec® cable glands with lamellar technology and anti-kink nozzle

Kurzes Anschlussgewinde metrisch | Short entry thread metric

Material: Polyamid PA 6
Eigenschaften: halogenfrei, schwarz UV beständig (getestet nach EN ISO 4892-2)
Dichtring: CR (Neopren)
Zugentlastung: Ausführung A nach EN 62444
Schutzart: IP 68
NEMA Type rating: 4X
Einsatztemperatur: -30 °C / +100 °C

Material: Polyamide PA 6
Properties: halogen-free, black UV resistant (tested according to EN ISO 4892-2)
Sealing ring: CR (neoprene)
Strain relief: Version A acc. to EN 62444
Protection class: IP 68
NEMA Type rating: 4X
Operation temperature: -30 °C / +100 °C

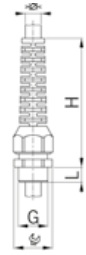

Hellgrau RAL 7035
Einteiliger Dichtring

Light grey RAL 7035
One-piece sealing ring

G	> Ø <	> Ø <	H	L	Art.-No.	
	min mm	max mm	mm	mm		
M12x1.5	2.5	6.5	15	54	1576.12.06	50
M16x1.5	4.0	8.0	19	64	1576.17.08	50
M20x1.5	3.0	7.0	24	88	1576.20.07	50
M20x1.5	5.5	12.0	24	88	1576.20.12	50



SYNTEC
mit Knickschutz



Schwarz RAL 9005
Einteiliger Dichtring

Black RAL 9005
One-piece sealing ring

G	> Ø <	> Ø <	H	L	Art.-No.	
	min mm	max mm	mm	mm		
M12x1.5	2.5	6.5	15	54	1546.12.06	50
M16x1.5	4.0	8.0	19	64	1546.17.08	50
M20x1.5	3.0	7.0	24	88	1546.20.07	50
M20x1.5	5.5	12.0	24	88	1546.20.12	50



SYNTEC
mit Knickschutz



Kabelverschraubungen Syntec® Kunststoff mit Lamellentechnik und Knickschutz Synthetic Syntec® cable glands with lamellar technology and anti-kink nozzle

Langes Anschlussgewinde metrisch | Long entry thread metric

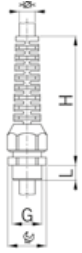

Material: Polyamid PA 6
Eigenschaften: halogenfrei, schwarz UV beständig (getestet nach EN ISO 4892-2)
Dichtring: CR (Neopren)
Zugentlastung: Ausführung A nach EN 62444
Schutzart: IP 68
NEMA Type rating: 4X
Einsatztemperatur: -30 °C / +100 °C

Material: Polyamide PA 6
Properties: halogen-free, black UV resistant (tested according to EN ISO 4892-2)
Sealing ring: CR (neoprene)
Strain relief: Version A acc. to EN 62444
Protection class: IP 68
NEMA Type rating: 4X
Operation temperature: -30 °C / +100 °C



Hellgrau RAL 7035
Einteiliger Dichtring

Light grey RAL 7035
One-piece sealing ring

G	> Ø < min mm	> Ø < max mm	mm	H mm	L mm	Art.-No.	
M12x1.5	2.5	6.5	15	54	12	1576.12.1.06	50
M16x1.5	4.0	8.0	19	64	12	1576.17.1.08	50
M20x1.5	3.0	7.0	24	88	13	1576.20.1.07	50
M20x1.5	5.5	12.0	24	88	13	1576.20.1.12	50

SYNTEC
mit Knickschutz



Schwarz RAL 9005
Einteiliger Dichtring

Black RAL 9005
One-piece sealing ring

G	> Ø < min mm	> Ø < max mm	mm	H mm	L mm	Art.-No.	
M12x1.5	2.5	6.5	15	54	12	1546.12.1.06	50
M16x1.5	4.0	8.0	19	64	12	1546.17.1.08	50
M20x1.5	3.0	7.0	24	88	13	1546.20.1.07	50
M20x1.5	5.5	12.0	24	88	13	1546.20.1.12	50

SYNTEC
mit Knickschutz



Kabelverschraubungen Syntec® Kunststoff mit Lamellentechnik und Knickschutz Synthetic Syntec® cable glands with lamellar technology and anti-kink nozzle

Anschlussgewinde Pg | Entry thread Pg

Material: Polyamid PA 6
Eigenschaften: halogenfrei, schwarz UV beständig (getestet nach EN ISO 4892-2)
Dichtring: CR (Neopren)
Schutzart: IP 68
NEMA Type rating: 4X
Einsatztemperatur: -30 °C / +100 °C

Material: Polyamide PA 6
Properties: halogen-free, black UV resistant (tested according to EN ISO 4892-2)
Sealing ring: CR (neoprene)
Protection class: IP 68
NEMA Type rating: 4X
Operation temperature: -30 °C / +100 °C

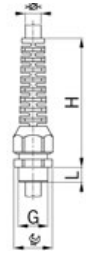

Hellgrau RAL 7035
Einteiliger Dichtring

Light grey RAL 7035
One-piece sealing ring

G	> Ø <	> Ø <	mm	H	L	Art.-No.	
	min mm	max mm	mm	mm	mm		
Pg 7	2.5	6.5	15	54	8	1576.07.06	50
Pg 9	3.0	8.0	19	64	8	1576.09.08	50
Pg 11	2.0	7.0	22	77	8	1576.11.07	50
Pg 11	4.0	10.0	22	77	8	1576.11.10	50
Pg 13	3.0	7.0	24	88	9	1576.13.07	50
Pg 13	5.5	12.0	24	88	9	1576.13.12	50
Pg 16	5.0	11.0	27	102	10	1576.16.11	50
Pg 16	8.5	14.0	27	102	10	1576.16.14	50



SYNTEC
mit Knickschutz



Schwarz RAL 9005
Einteiliger Dichtring

Black RAL 9005
One-piece sealing ring

G	> Ø <	> Ø <	mm	H	L	Art.-No.	
	min mm	max mm	mm	mm	mm		
Pg 7	2.5	6.5	15	54	8	1546.07.06	50
Pg 9	3.0	8.0	19	64	8	1546.09.08	50
Pg 11	2.0	7.0	22	77	8	1546.11.07	50
Pg 11	4.0	10.0	22	77	8	1546.11.10	50
Pg 13	3.0	7.0	24	88	9	1546.13.07	50
Pg 13	5.5	12.0	24	88	9	1546.13.12	50
Pg 16	5.0	11.0	27	102	10	1546.16.11	50
Pg 16	8.5	14.0	27	102	10	1546.16.14	50



SYNTEC
mit Knickschutz



Kabelverschraubungen Syntec® Kunststoff mit Lamellentechnik und Knickschutz Synthetic Syntec® cable glands with lamellar technology and anti-kink nozzle

Anschlussgewinde NPT | Entry thread NPT

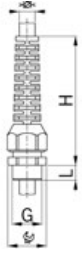

Material: Polyamid PA 6
Eigenschaften: halogenfrei, schwarz UV beständig (getestet nach EN ISO 4892-2)
Dichtring: CR (Neopren)
Schutzart: IP 54
Gewinde: IP 68, wenn Anschlussgewinde abgedichtet
NEMA Type rating: 4X
Einsatztemperatur: -30 °C / +100 °C

Material: Polyamide PA 6
Properties: halogen-free, black UV resistant (tested according to EN ISO 4892-2)
Sealing ring: CR (neoprene)
Protection class: IP 54
Entry thread: IP 68, if the entry thread is sealed
NEMA Type rating: 4X
Operation temperature: -30 °C / +100 °C



Hellgrau RAL 7035
Einteiliger Dichtring

Light grey RAL 7035
One-piece sealing ring

G	>Ø <	>Ø <	mm	H	L	Art.-No.	
	min mm	max mm		mm	mm		
NPT 3/8"	3.0	8.0	19/22	64	15	1576.N0375.08	50
NPT 1/2"	3.0	7.0	24	88	15	1576.N0500.07	50
NPT 1/2"	5.5	12.0	24	88	15	1576.N0500.12	50

SYNTEC
mit Knickschutz



Schwarz RAL 9005
Einteiliger Dichtring

Black RAL 9005
One-piece sealing ring

G	>Ø <	>Ø <	mm	H	L	Art.-No.	
	min mm	max mm		mm	mm		
NPT 3/8"	3.0	8.0	19/22	64	15	1546.N0375.08	50
NPT 1/2"	3.0	7.0	24	88	15	1546.N0500.07	50
NPT 1/2"	5.5	12.0	24	88	15	1546.N0500.12	50

SYNTEC
mit Knickschutz





Winkel-Kabelverschraubungen 90° Kunststoff Cable glands elbow 90° synthetic		235
Flanschwinkel 90° Kunststoff Synthetic flanged elbow 90°		236
Quickseal Kabeleinführungstüllen Quickseal cable grommets		237
Würgenippel Kunststoff Synthetic locking plug		238

1

2

3

4

5

6

7

8

9

10

11

12

13

14

15

Flanschwinkel und Winkel

Flanged elbows and elbows



Sind bei der Kabelinstallation enge Raumverhältnisse gegeben, kann der Anwender auf die Vorteile von **Winkeln und Flanschwinkeln** bauen.

Hier werden Leitungen um die Ecke geführt und je nach der verwendeten Kabelverschraubung zu 100% vor der Knickstelle zugentlastet.

Bei den Kunststoff-Flanschwinkeln erleichtert zudem ein spezieller Klappmechanismus die Kabelinstallation.

Die Quickseal Kabeleinführungstüllen sind spezielle Durchführungsmembranen und können auch als Verschlussstopfen verwendet werden. Zur Montage wird kein Werkzeug benötigt. Einfach Kabeldurchführung einstecken. Danach wird die geschlossene Membran durch Einstecken des durchzuführenden Kabels durchstossen.

Die Würgenippel aus Kunststoff sind für den Einsatz in Installationsbereichen ohne besonderen Einsatz bestens geeignet. Erhältlich mit und ohne Bohrung.

If space is limited, the user can take advantage of the benefits of **elbow fittings – either flanged or unflanged** – for cable installations.

The cables are routed around the bend and, depending upon the type of cable gland used, completely relieved of any strain before the bend.

In the case of flanged elbow fittings made of plastic, their special two-part design simplifies cable installation.

Quickseal cable grommets are special feedthrough membranes which can also be used as sealing caps. No tools are needed for installation – simply insert the cable grommet. Afterwards, the cable to be fed through is simply pushed through the closed membrane.

The synthetic sealing plugs are especially well suited for use in electrical installation work requiring little effort or expertise. Available with or without feedthrough holes.

Winkel-Kabelverschraubungen 90° Kunststoff

Cable glands elbow 90° synthetic

Anschlussgewinde metrisch | Entry thread metric

Material: Polyamid PA 6
 Dichtung: TPE
 Schutzart: IP 68
 Einsatztemperatur: -20 °C / +100 °C

Material: Polyamide PA 6
 Seal: TPE
 Protection class: IP 68
 Operation temperature: -20 °C / +100 °C

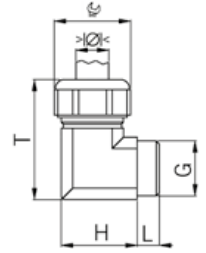

Grau RAL 7032
 Einteiliger Dichteinsatz

Grey RAL 7032
 One-piece sealing insert

G	$\begin{matrix} > \varnothing < \\ \text{min mm} \end{matrix}$	$\begin{matrix} > \varnothing < \\ \text{max mm} \end{matrix}$	$\begin{matrix} \varnothing \\ \text{mm} \end{matrix}$	H	T	L	Art.-No.	
M16x1.5	6.5	9.5	19	23	38	8	5215.17.95	25
M20x1.5	7.0	10.5	24	28	46	9	5215.20.105	25
M20x1.5	9.0	13.0	24	28	46	9	5215.20.13	25
M25x1.5	11.5	15.5	27	32	52	10	5215.25.155	25



Schwarz RAL 9005
 Einteiliger Dichteinsatz

Black RAL 9005
 One-piece sealing insert

G	$\begin{matrix} > \varnothing < \\ \text{min mm} \end{matrix}$	$\begin{matrix} > \varnothing < \\ \text{max mm} \end{matrix}$	$\begin{matrix} \varnothing \\ \text{mm} \end{matrix}$	H	T	L	Art.-No.	
M16x1.5	6.5	9.5	19	23	38	8	5215.17.40.95	25
M20x1.5	7.0	10.5	24	28	46	9	5215.20.40.105	25
M20x1.5	9.0	13.0	24	28	46	9	5215.20.40.13	25
M25x1.5	11.5	15.5	27	32	52	10	5215.25.40.155	25



Anschlussgewinde Pg | Entry thread Pg

Grau RAL 7032
 Einteiliger Dichteinsatz

Grey RAL 7032
 One-piece sealing insert

G	$\begin{matrix} > \varnothing < \\ \text{min mm} \end{matrix}$	$\begin{matrix} > \varnothing < \\ \text{max mm} \end{matrix}$	$\begin{matrix} \varnothing \\ \text{mm} \end{matrix}$	H	T	L	Art.-No.	
Pg 9	4.5	6.5	19	23	38	8	5215.09.65	25
Pg 9	6.5	9.5	19	23	38	8	5215.09.95	25
Pg 11	7.0	10.5	22	25	42	9	5215.11.105	25
Pg 11	4.0	6.5	22	25	42	9	5215.11.65	25
Pg 11	6.5	9.5	22	25	42	9	5215.11.95	25
Pg 13	7.0	10.5	24	28	46	9	5215.13.105	25
Pg 13	9.0	13.0	24	28	46	9	5215.13.13	25
Pg 13	6.5	9.5	24	32	46	9	5215.13.95	25
Pg 16	7.0	10.5	27	32	52	10	5215.16.105	25
Pg 16	9.0	13.0	27	32	52	10	5215.16.13	25
Pg 16	11.5	15.5	27	32	52	10	5215.16.155	25
Pg 16	6.5	9.5	27	32	52	10	5215.16.95	25



Flanschwinkel 90° Kunststoff

Synthetic flanged elbow 90°

Anschlussgewinde metrisch | Entry thread metric

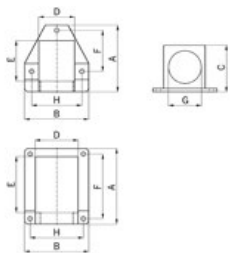



Material: Polyamid
 Dichtung: NBR
 Schutzart: IP 65
 Eigenschaften: Der Flanschwinkel lässt sich aufklappen.
 Einsatztemperatur: -40 °C / +110 °C

Material: Polyamide
 Seal: NBR
 Protection class: IP 65
 Properties: The flange angle can be unfolded.
 Operation temperature: -40 °C / +110 °C



Grau



Grey

G	A mm	B mm	C mm	D mm	E mm	F mm	H mm		Art.-No.	
M16x1.5	49	47	35	22	27	29	37	3	5500.20.17	10
M20x1.5	49	47	35	22	27	29	37	3	5500.20.20	10
M25x1.5	69	65	44	30	31	42	52	3	5500.20.25	10
M32x1.5	90	78	55	40	65	65	65	4	5500.20.32	10
M40x1.5	100	94	66	48	68	80	80	4	5500.20.40	5
M50x1.5	116	101	76	63	85	88	88	4	5500.20.50	5



Schwarz

Black

G	A mm	B mm	C mm	D mm	E mm	F mm	H mm		Art.-No.	
M16x1.5	49	47	35	22	27	29	37	3	5500.40.17	10
M20x1.5	49	47	35	22	27	29	37	3	5500.40.20	10
M25x1.5	69	65	44	30	31	42	52	3	5500.40.25	10
M32x1.5	90	78	55	40	65	65	65	4	5500.40.32	10
M40x1.5	100	94	66	48	68	80	80	4	5500.40.40	5
M50x1.5	116	101	76	63	85	88	88	4	5500.40.50	5

Anschlussgewinde Pg | Entry thread Pg



Grau



Grey

G	A mm	B mm	C mm	D mm	E mm	F mm	H mm		Art.-No.	
Pg 11	49	47	35	22	27	29	37	3	5520.11	10
Pg 16	49	47	35	22	27	29	37	3	5520.16	10
Pg 21	69	65	44	30	31	42	52	3	5520.21	10
Pg 29	90	78	55	40	65	65	65	4	5520.29	10
Pg 36	100	94	66	48	68	80	80	4	5520.36	5



Schwarz

Black

G	A mm	B mm	C mm	D mm	E mm	F mm	H mm		Art.-No.	
Pg 11	49	47	35	22	27	29	37	3	5540.11	10
Pg 16	49	47	35	22	27	29	37	3	5540.16	10
Pg 21	69	65	44	30	31	42	52	3	5540.21	10
Pg 29	90	78	55	40	65	65	65	4	5540.29	10
Pg 36	100	94	66	48	68	80	80	4	5540.36	5
Pg 48	116	101	76	63	85	88	88	4	5540.48.48	5

Metrische Nenngrossen | Metric rating

Material: EPDM
 Schutzart: IP 67
 Eigenschaften: Halogenfrei, allseitig IP 67 durch 'Pushout-Membrane', gute Chemikalien- und Witterungsbeständigkeit

Material: EPDM
 Protection class: IP 67
 Properties: Halogen-free, all-round IP 67 protection thanks to the "pushout-membrane", resistant to chemicals and weatherproof

Einsatzbereich: Universell einsetzbar bei Wandstärken von 1 bis 4 mm (M16 - M50) bzw. 0.5 bis 2 mm (M12)

Application: Suitable for holes in materials of 1 - 4 mm (M16 - M50), or M12 from 0.5 - 2 mm

Einsatztemperatur: -40 °C / +110 °C

Operation temperature: -40 °C / +110 °C

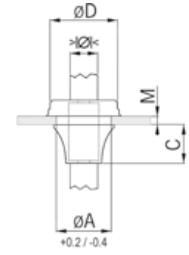

Dunkelgrau RAL 7001						Dark grey RAL 7001	
ØA mm	>Ø< min mm	>Ø< max mm	M mm	C mm	ØD mm	Art.-No.	
12.5	4.0	7.0	0.5-2	5.6	20.0	14.582.33	50
16.5	5.0	9.0	1-4	11.0	21.0	14.582.34	50
20.5	8.0	13.0	1-4	13.4	25.5	14.582.35	50
25.5	11.0	17.0	1-4	15.3	30.5	14.582.36	50
32.5	15.0	20.0	1-4	18.6	38.5	14.582.37	25
40.5	19.0	28.0	1-4	21.7	48.5	14.582.38	25
50.5	27.0	35.0	1-4	25.0	60.5	14.582.39	10



Hellgrau RAL 7035						Light grey RAL 7035	
ØA mm	>Ø< min mm	>Ø< max mm	M mm	C mm	ØD mm	Art.-No.	
12.5	4.0	7.0	0.5-2	5.6	20.0	14.583.03	50
16.5	5.0	9.0	1-4	11.0	21.0	14.583.04	50
20.5	8.0	13.0	1-4	13.4	25.5	14.583.05	50
25.5	11.0	17.0	1-4	15.3	30.5	14.583.06	50
32.5	15.0	20.0	1-4	18.6	38.5	14.583.07	25
40.5	19.0	28.0	1-4	21.7	48.5	14.583.08	25
50.5	27.0	35.0	1-4	25.0	60.5	14.583.09	10



Schwarz RAL 9005						Black RAL 9005	
ØA mm	>Ø< min mm	>Ø< max mm	M mm	C mm	ØD mm	Art.-No.	
12.5	4.0	7.0	0.5-2	5.6	20.0	14.582.93	50
16.5	5.0	9.0	1-4	11.0	21.0	14.582.94	50
20.5	8.0	13.0	1-4	13.4	25.5	14.582.95	50
25.5	11.0	17.0	1-4	15.3	30.5	14.582.96	50
32.5	15.0	20.0	1-4	18.6	38.5	14.582.97	25
40.5	19.0	28.0	1-4	21.7	48.5	14.582.98	25
50.5	27.0	35.0	1-4	25.0	60.5	14.582.99	10



Würgenippel Kunststoff

Synthetic locking plug

Anschlussgewinde metrisch | Entry thread metric

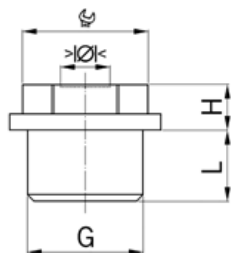

Material: Polyethylen
 Schutzart: IP 54
 Einsatztemperatur: -20 °C / +70 °C

Material: Polyethylene
 Protection class: IP 54
 Operation temperature: -20 °C / +70 °C



Hellgrau RAL 7035
 mit Bohrung

Light grey RAL 7035
 with bore hole

G	>Ø< min mm	>Ø< max mm	mm	H mm	L mm	Art.-No.	
M16x1.5	5.0	10.8	15	7	10	1620.17	100
M20x1.5	8.0	13.5	19	8	12	1620.20	100
M25x1.5	9.0	16.0	24	10	12	1620.25	100
M32x1.5	11.0	22.0	30	11	14	1620.32	50
M40x1.5	17.0	24.0	37	12	16	1620.40	25
M50x1.5	22.0	35.0	46	13	18	1620.50	10
M63x1.5	24.0	43.0	56	15	20	1620.63	10











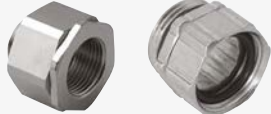

Hellgrau RAL 7035
 ohne Bohrung

Light grey RAL 7035
 without bore hole

G	>Ø< min mm	>Ø< max mm	mm	H mm	L mm	Art.-No.	
M16x1.5	5.0	10.8	15	7	10	1600.17	100
M20x1.5	8.0	13.5	19	8	12	1600.20	100
M25x1.5	9.0	16.0	24	10	12	1600.25	100
M32x1.5	11.0	22.0	30	11	14	1600.32	100
M40x1.5	17.0	24.0	37	12	16	1600.40	25
M50x1.5	22.0	35.0	46	13	18	1600.50	10
M63x1.5	24.0	43.0	56	15	20	1600.63	10



<p>Druckausgleichselemente Messing und Kunststoff Pressure balance elements nickel-plated brass and synthetic</p>	 <p>242 - 245</p>	1
<p>Universal-Drehadapter und Richtungsfeststeller Messing Universal swivel adapters and adjustable fixing devices nickel-plated brass</p>	 <p>246</p>	2
<p>Gegenmuttern Messing Sealing nuts nickel-plated brass</p>	 <p>247 - 251</p>	3
<p>Gegenmuttern Kunststoff Synthetic lock nuts</p>	 <p>252 - 255</p>	4
<p>Reduktionen und Erweiterungen Messing Reduction and enlarging fittings nickel-plated brass</p>	 <p>256 - 265</p>	5
<p>Reduktionen und Erweiterungen Kunststoff Synthetic reduction and enlarging fittings</p>	 <p>266 - 269</p>	6
<p>Verschlusschrauben Metall und Kunststoff Sealing plugs metal and synthetic</p>	 <p>270 - 275</p>	7
<p>Dichteinsätze Vollgummi Solid rubber sealing inserts</p>	 <p>276 - 277</p>	9
<p>O-Ringe und Dichtungsscheiben O-rings and sealing washers</p>	 <p>278 - 281</p>	10
<p>Blindscheiben, Verschlussbolzen, Einschnittringe Blind discs, locking pins, sealing rings</p>	 <p>282 - 283</p>	11
<p>Spezialwerkzeug Special tool</p>	 <p>284</p>	12
<p>AGRO Geflechschläuche Kunststoff AGRO Synthetic braided cable sleeving</p>	 <p>285 - 291</p>	13



Dank einer Reihe kleiner Helfer bei der Kabeleinführung lassen sich Produktionsanlagen problemlos an neue Aufgaben oder Gegebenheiten anpassen. Dabei kann nicht nur die Anzahl der Leitungen abweichen, sondern es können sich auch etliche Kabeldurchmesser ändern. Um hier den Arbeitsaufwand an Gehäusen und Schaltschränken zu minimieren, empfiehlt sich der Einsatz von Erweiterungen und Reduktionen. So können zum Beispiel einzelne Adern von dicken Kabeln durch eine Erweiterung in das Gehäuse eingeführt werden, wobei die äussere Leitungsisolierung in der Kabelverschraubung endet. Hierbei bleibt die vorhandene Schutzart selbstverständlich erhalten.

Überflüssige Gehäuseöffnungen werden durch den Einsatz von Verschlusschrauben abgedichtet und somit vor dem Eindringen von Schmutz bewahrt. Falls keine Gewindebohrung vorhanden ist, können Gegenmuttern verwendet werden.

Thanks to a range of cable entry accessories, production systems can be easily adapted to new tasks or situations. Not only can the number of cables change, but the cable diameters can also. To minimise the work on housings and control cabinets, the use of reduction and enlarging fittings may be recommended. An enlarging fitting, for example, can be used to route the individual wires of a thick cable into a housing with the outer cable insulation terminating in the cable gland. It goes without saying that the existing protection class is maintained.

Redundant housing openings can be blocked using locking screws to prevent the ingress of dirt.

If existing holes are not threaded, locknuts can be used.

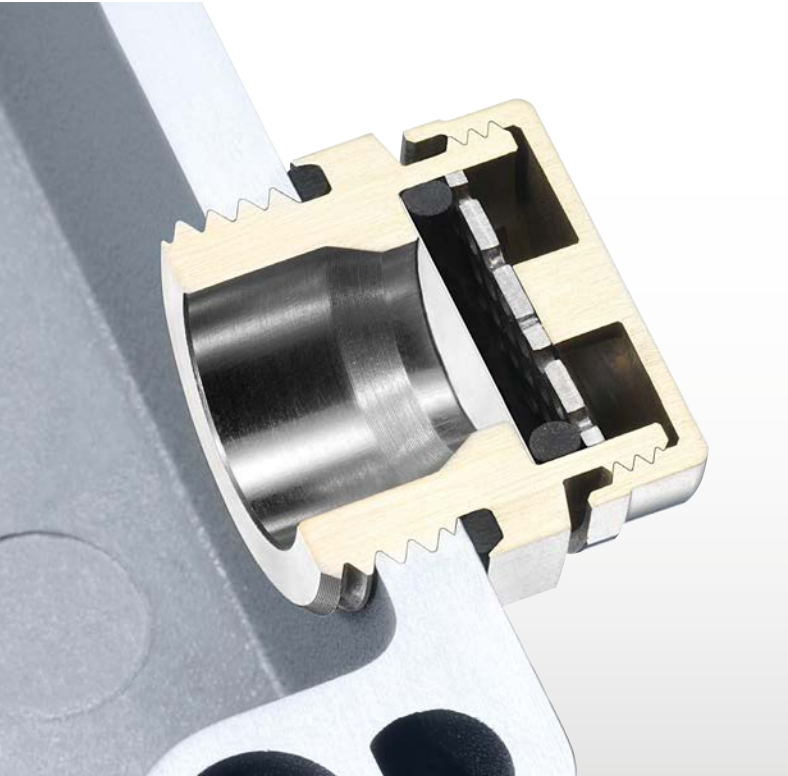

Kunststoff- oder Messing-Druckausgleichselemente mit Membrane:

Eine Spezialmembrane aus PES Polyethersulfon verfügt über Poren, die viele hundertmal grösser sind als Wasserdampfmoleküle, jedoch etliche tausendmal kleiner als Wassertropfen. Sie sorgt für einen problemlosen Luftaustausch und somit für ein trockenes Innengehäuse. Ihre spezielle Struktur bewirkt, dass die AGRO Druckausgleichselemente luft- aber nicht wasserdurchlässig sind. Die Schutzart IP 68 bleibt bis zu einem Druck von 0,8 bar erhalten. Die Membrane ist wasser-, öl- und schmutzabweisend.

Das Druckausgleichselement mit Membrane ist auch in Ex-Ausführung für erhöhte Sicherheit Ex e II erhältlich.

Druckausgleichselement mit Sinterfilter:

Durch den gröberen Materialaufbau der Sinterscheibe ist ein wesentlich grösserer Luftaustausch möglich. Extreme Druck- und Feuchtigkeitsschwankungen können bei sehr grossen Gehäusen mühelos ausgeglichen werden. Die Sinterscheibe ist spritzwasser- und insektensicher.

Entwässerungselement mit Sieb:

Bei Anwendungsfällen, bei denen auf Grund der Umweltbedingungen immer mit einer Kondenswasserbildung zu rechnen ist, kommen Entwässerungselemente zum Einsatz. Hier sorgt ein spezielles Edelstahlsieb für einen schnellen Wasserabfluss, welches aber den Gehäuseinnenraum auf Grund seiner feinen Maschengrösse vor Insekten und Schmutzpartikeln über 0,2 mm schützt. Die Installation des Entwässerungselementes erfolgt vorzugsweise am tiefsten Gehäusepunkt.

Zur Optimierung des Wasserabflusses stehen bei Durchgangsöffnungen partiell geschlitzte Gegenmuttern zur Verfügung.



Pressure balance elements made of synthetic material or nickel-plated brass with membrane:

A special membrane of PES (polyethersulfone) has pores which are many hundreds of times bigger than water vapour molecules but thousands of times smaller than water droplets. It allows easy air exchange and thus ensures that the enclosed area remains dry. Its special structure makes this AGRO pressure balance element air-permeable but not water-permeable. The element is rated IP 68 at pressures of up to 0.8 bars. Its membrane is water-, oil- and dirt-repellent.

Pressure balance element with membrane available for hazardous area for increased safety Ex e II.

Pressure balance element with sinter filter:

The coarser nature of the sinter disc's material allows greater air transfer. Extreme pressure and moisture fluctuations in very large housings can be easily balanced. The sinter disc protects against splashing of water and insects.

Drainage element with mesh:

In applications where, due to environmental conditions, condensation of water is to be expected, drainage elements are used. A special stainless steel mesh allows water to drain away quickly, but protects the enclosed area from insects and dust particles larger than 0.2 mm. This element is typically located at a housing's lowest point. For optimal drainage, partially slotted counter nuts are available.

1

2

3

4

5

6

7

8

9

10

11

12

13

14

15

Kunststoff Druckausgleichselement mit Membrane

Synthetic pressure balance element with membrane

Anschlussgewinde metrisch | Entry thread metric

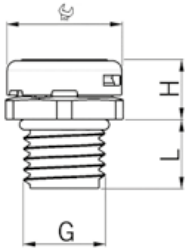

Material: Polyamid PA 6
 Membrane: PES Polyethersulfon
 O-Ring: NBR
 Schutzart: IP 66 / IP 68 / IP 69
 Wassereintrittsdruck: IP 68 = 0.2 bar / 30 min
 Luftdurchsatz: > 90 ml / min / cm² bei 10 mbar
 Eigenschaften: halogenfrei, schwarz UV beständig (getestet nach EN ISO 4892-2)
 Einsatztemperatur: -40 °C / +100 °C

Material: Polyamide PA 6
 Membrane: PES polyethersulfone
 O-ring: NBR
 Protection class: IP 66 / IP 68 / IP 69
 Water intrusion pressure: IP 68 = 0.2 bar / 30 min
 Air flow rate: > 90 ml / min / cm² at 10 mbar
 Properties: halogen-free, black UV resistant (tested according to EN ISO 4892-2)
 Operation temperature: -40 °C / +100 °C



mit Membrane
Schwarz RAL 9005

with membrane
Black RAL 9005

G		H	L
mm	mm	mm	mm
M12x1.5	17	9	10

Art.-No.



2445.12

25

Anschlussgewinde metrisch | Entry thread metric

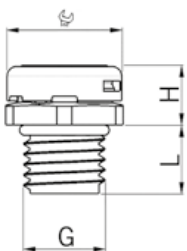

Material: Polyamid PA 6
 Membrane: PES Polyethersulfon
 O-Ring: NBR
 Schutzart: IP 66 / IP 68 / IP 69
 Wassereintrittsdruck: IP 68 = 0.2 bar / 30 min
 Luftdurchsatz: > 90 ml / min / cm² bei 10 mbar
 Eigenschaften: halogenfrei
 Einsatztemperatur: -40 °C / +100 °C

Material: Polyamide PA 6
 Membrane: PES polyethersulfone
 O-ring: NBR
 Protection class: IP 66 / IP 68 / IP 69
 Water intrusion pressure: IP 68 = 0.2 bar / 30 min
 Air flow rate: > 90 ml / min / cm² at 10 mbar
 Properties: halogen-free
 Operation temperature: -40 °C / +100 °C



mit Membrane
Hellgrau RAL 7035

with membrane
Light grey RAL 7035

G		H	L
mm	mm	mm	mm
M12x1.5	17	9	10

Art.-No.



2455.12

25

Druckausgleichselement Messing mit Membrane



Pressure balance element nickel-plated brass with membrane

Anschlussgewinde metrisch | Entry thread metric

Material: Messing vernickelt
 Membrane: PES Polyethersulfon
 O-Ring: NBR
 Schutzart: IP 66 / IP 68 / IP 69
 Wassereintrittsdruck: IP 68 = 0.2 bar / 30 min
 Luftdurchsatz: > 90 ml / min / cm²
 bei 10 mbar
 Einsatztemperatur: -60 °C / +100 °C

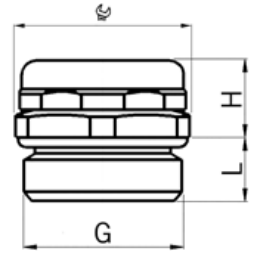

Material: Nickel-plated brass
 Membrane: PES polyethersulfone
 O-ring: NBR
 Protection class: IP 66 / IP 68 / IP 69
 Water intrusion pressure: IP 68 = 0.2 bar / 30 min
 Air flow rate: > 90 ml / min / cm²
 at 10 mbar
 Operation temperature: -60 °C / +100 °C



mit Membrane mit O-Ring				with membrane with O-ring			
G	 mm	H mm	L mm	Art.-No.			
M12x1.5	18	9.5	8	2450.12.34	25		
M16x1.5	18	9.5	8	2450.17.34	20		
M20x1.5	22	10.0	8	2450.20.34	20		
Auf Anfrage lieferbar: Rostfreier Stahl A2 oder A4				Available on request: Stainless steel A2 or A4			



Anschlussgewinde Pg | Entry thread Pg

mit Membrane mit O-Ring				with membrane with O-ring			
G	 mm	H mm	L mm	Art.-No.			
Pg 7	18	9.5	8	2450.07.34	25		
Pg 11	22	10.0	8	2450.11.34	20		
Auf Anfrage lieferbar: Rostfreier Stahl A2 oder A4				Available on request: Stainless steel A2 or A4			



1
2
3
4
5
6
7
8
9
10
11
12
13
14
15

Druckausgleichselement Messing mit Sinterfilter

Pressure balance element nickel-plated brass with sintered filter

Anschlussgewinde metrisch | Entry thread metric

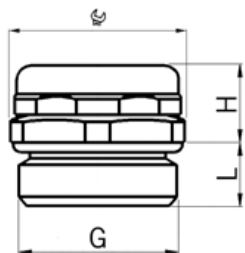



Material: Messing vernickelt
 Filterscheibe: Sinterbronze
 O-Ring: NBR
 Schutzart: IP 54 / IP x9
 Filtergrad: 40 µm
 Einsatztemperatur: -50 °C / +110 °C

Material: Nickel-plated brass
 Filter disc: Sintered bronze
 O-ring: NBR
 Protection class: IP 54 / IP x9
 Degree of filter: 40 µm
 Operation temperature: -50 °C / +110 °C



mit Sinterfilter
mit O-Ring

Sintered filter
with O-ring

G	 mm	H mm	L mm	Art.-No.	
M12x1.5	18	9.5	8	2450.12.32	25
M16x1.5	18	9.5	8	2450.17.32	20
M20x1.5	22	10.0	8	2450.20.32	20

Auf Anfrage lieferbar:
Rostfreier Stahl A2 oder A4
Für hohe Temperaturen (+200°C)



Available on request:
Stainless steel A2 or A4
For high temperature applications (+200°C)

Anschlussgewinde Pg | Entry thread Pg



mit Sinterfilter
mit O-Ring

Sintered filter
with O-ring

G	 mm	H mm	L mm	Art.-No.	
Pg 7	18	9.5	8	2450.07.32	25
Pg 11	22	10.0	8	2450.11.32	20

Auf Anfrage lieferbar:
Rostfreier Stahl A2 oder A4
Für hohe Temperaturen (+200°C)



Available on request:
Stainless steel A2 or A4
For high temperature applications (+200°C)

Anschlussgewinde metrisch | Entry thread metric

Material: Messing vernickelt
 Sieb: Rostfreier Stahl A2
 O-Ring: NBR
 Schutzart: IP 4x
 Einsatztemperatur: -50 °C / +110 °C

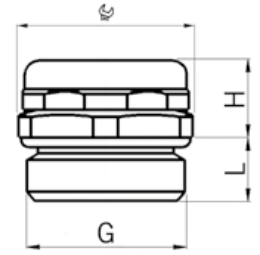
Material: Nickel-plated brass
 Mesh: Stainless steel A2
 O-ring: NBR
 Protection class: IP 4x
 Operation temperature: -50 °C / +110 °C



mit Sieb mit O-Ring		with mesh with O-ring		Art.-No.	
G	 mm	H mm	L mm		
M12x1.5	18	9.5	10	2450.12.36	25
M16x1.5	18	9.5	10	2450.17.36	20
M20x1.5	22	10.0	10	2450.20.36	20

Auf Anfrage lieferbar:
Rostfreier Stahl A2 oder A4



Available on request:
Stainless steel A2 or A4

Anschlussgewinde metrisch | Entry thread metric

Material: Messing vernickelt
 Einsatztemperatur: -50 °C / +200 °C

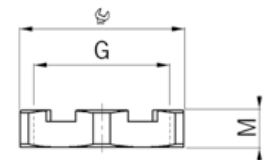
Material: Nickel-plated brass
 Operation temperature: -50 °C / +200 °C



zu Entwässerungselement		for drainage element		Art.-No.	
G	 mm	M mm			
M12x1.5	15	4.5		8324.12	25
M16x1.5	19	5.5		8324.17	20
M20x1.5	24	5.5		8324.20	20

Universal-Drehadapter Messing

Universal swivel adapter nickel-plated brass

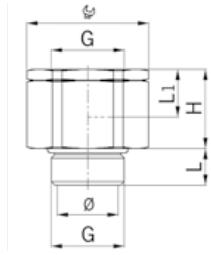

Kurzes Anschlussgewinde metrisch | Short entry thread metric



Material: Messing vernickelt
 Dichtringe: NBR
 Schutzart: IP 68
 Eigenschaften: Universell verwendbar mit Kabel- oder Schlauchverschraubungen, gute Drehfreudigkeit durch spezielle Lagerung
 Einsatztemperatur: -40 °C / +100 °C

Material: Nickel-plated brass
 Sealing rings: NBR
 Protection class: IP 68
 Properties: Multifunctional use in combination with cable- or conduit glands, smooth rotation due to a special bearing
 Operation temperature: -40 °C / +100 °C



G		H mm	L mm	L1 mm	Ø mm	Art.-No.	
M16x1.5	24	20	10	12	11.0	2410.17	25
M20x1.5	30	22	10	13	15.5	2410.20	25
M25x1.5	36	24	11	13	20.5	2410.25	25
M32x1.5	46	27	13	14	28.0	2410.32	10
M40x1.5	55	28	13	15	35.0	2410.40	10
M50x1.5	65	32	14	16.5	43.0	2410.50	5

Achtung! Der Universal-Drehadapter kann kein Kugel- oder Wälzlager ersetzen!

Attention! The swivel adapter can not replace rolling- or ball bearings!

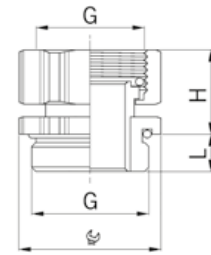

Anschlussgewinde metrisch | Entry thread metric



Material: Messing vernickelt
 O-Ring: 2 x NBR
 Schutzart: IP 68
 Einsatzbereich: Besonders geeignet für die richtungsstabile Montage von Winkeln
 Einsatztemperatur: -40 °C / +100 °C

Material: Nickel-plated brass
 O-ring: 2 x NBR
 Protection class: IP 68
 Application: Suitable for directionally stable mounting of elbows
 Operation temperature: -40 °C / +100 °C



G		H mm	L mm	Art.-No.	
M16x1.5	18	14	6	5000.17.50	50
M20x1.5	22	14	6.5	5000.20.50	50
M25x1.5	28	15	7	5000.25.50	50
M32x1.5	35	18	8	5000.32.50	50

Richtungsfeststeller mit O-Ring

Adjustable fixing devices with O-ring

Anschlussgewinde metrisch | Entry thread metric

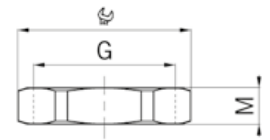

Material: Messing vernickelt
 Ausführung: 6-kant
 Einsatztemperatur: -60 °C / +200 °C

Material: Nickel-plated brass
 Execution: Hexagonal design
 Operation temperature: -60 °C / +200 °C



Gewinde metrisch

Metric thread

G	 mm	M mm	i info	Art.-No.	
M6x0.75	9	2.8	-	8000.06.1	50
M6x1.0	9	2.8	1	8000.06	50
M8x1.0	11	2.8	-	8000.08.1	50
M8x1.25	11	2.8	1	8000.08	50
M10x1.0	13	2.8	-	8000.10.1	50
M10x1.5	13	2.8	1	8000.10	50
M12x1.5	15	3.0	-	8000.12	100
M16x1.5	19	3.0	-	8000.17	100
M20x1.5	24	3.5	-	8000.20	100
M25x1.5	30	4.0	-	8000.25	50
M32x1.5	36	4.0	-	8000.32	25
M40x1.5	46	5.0	-	8000.40	25
M50x1.5	55	5.5	-	8000.50	10
M63x1.5	70	6.0	-	8000.63	10
M75x1.5	80	6.0	-	8000.75	10
M80x2.0	95	8	-	8000.080	5
M85x2.0	95	8.0	-	8000.085	5
M95x2.0	110	9.0	-	8000.095	5
M100x3.0	115	9.0	-	8000.100	1
M105x3.0	120	9.0	-	8000.105	1
M115x3.0	125	10.0	-	8000.115	1

1 = Metrisches Regelgewinde

1 = Metric coarse-pitch thread

Anschlussgewinde Pg | Entry thread Pg

Gewinde Pg

Pg thread

G	 mm	M mm	Art.-No.	
Pg 7	15	3.0	8007	50
Pg 9	18	3.0	8009	50
Pg 11	21	3.0	8011	50
Pg 13	23	3.0	8013	50
Pg 16	26	3.0	8016	50
Pg 21	32	3.5	8021	25
Pg 29	41	4.0	8029	10
Pg 36	51	5.0	8036	10
Pg 42	60	5.0	8042	10
Pg 48	65	5.5	8048.48	10



1
2
3
4
5
6
7
8
9
10
11
12
13
14
15

Gegenmuttern Messing

Lock nuts nickel-plated brass

Anschlussgewinde Gasrohr | Gas-pipe entry thread

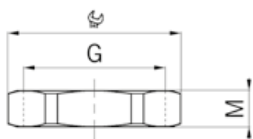

Material: Messing vernickelt
 Ausführung: 6-kant
 Einsatztemperatur: -60 °C / +200 °C

Material: Nickel-plated brass
 Execution: Hexagonal design
 Operation temperature: -60 °C / +200 °C



Gasrohr-Gewinde

Gas-pipe thread

G	 mm	M mm	i info	Art.-No.	
G 3/8"	19	3.0	-	803/8G	10
G 1/2"	24	3.0	-	801/2G	10
G 5/8"	26	3.0	-	805/8G	10
G 3/4"	30	3.5	-	803/4G	10
G 1"	38	4.5	-	801G	10
G 1 1/2"	51	5.0	-	8011/2G	10
G 1 1/4"	46	5.0	-	8011/4G	10
G 2"	65	5.5	-	8048	5
G 2 1/2"	90	12.0	1	8050	5
G 3"	105	12.0	1	8051	5

1 = Runde Bauform, Stahl verzinkt

1 = Round form, zinc coated steel

Anschlussgewinde metrisch | Entry thread metric



Dicke Ausführung

Thick-walled version

G	 mm	M mm	Art.-No.	
M12x1.5	15	5.0	8300.12	50
M16x1.5	19	5.0	8300.17	50
M20x1.5	24	5.5	8300.20	50
M25x1.5	30	5.5	8300.25	50
M32x1.5	36	6.0	8300.32	50
M40x1.5	46	7.0	8300.40	50

Anschlussgewinde Pg | Entry thread Pg



Dicke Ausführung

Thick-walled version

G	 mm	M mm	Art.-No.	
Pg 7	15	5.0	8300.07	50
Pg 9	18	5.0	8300.09	50
Pg 11	21	5.0	8300.11	50
Pg 13	24	5.5	8300.13	50
Pg 16	26	5.5	8300.16	50
Pg 21	32	6.0	8300.21	50
Pg 29	41	7.0	8300.29	50

Gegenmuttern Messing mit Hinterstich für O-Ring

Lock nuts nickel-plated brass with recess for O-ring

Anschlussgewinde metrisch | Entry thread metric

Material: Messing vernickelt
 Ausführung: 6-kant
 O-Ring: Separat bestellen
 Einsatztemperatur: -60 °C / +200 °C

Material: Nickel-plated brass
 Execution: Hexagonal design
 O-ring: To be ordered separately
 Operation temperature: -60 °C / +200 °C

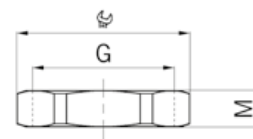

Dicke Ausführung
 ohne O-Ring

Thick-walled version
 without O-Ring

G	 mm	M	O-ring	Art.-No.	
M12x1.5	15	5.0	1007.00.08	8300.12.1	50
M16x1.5	19	5.0	1016.00.15.08	8300.17.1	50
M20x1.5	24	5.5	1016.00.08	8300.20.1	50
M25x1.5	30	5.5	1013.00.22.08	8300.25.1	50
M32x1.5	36	6.0	1021.00.30.08	8300.32.1	50
M40x1.5	46	7.0	1029.00.39.08	8300.40.1	50
M50x1.5	55	7.5	1036.00.49.08	8300.50.1	10
M63x1.5	70	8.0	1048.00.62.08	8300.63.1	10

1
2
3
4
5
6
7
8
9
10
11
12
13
14
15

Gegenmuttern rostfreier Stahl

Stainless steel lock nuts

Rostfreier Stahl A2 | Stainless steel A2

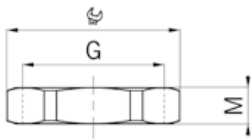

Material: Rostfreier CrNi-Stahl A2
(DIN EN 1.4305 / AISI 303)
Ausführung: 6-kant
Einsatztemperatur: -60 °C / +300 °C

Material: CrNi stainless steel A2
(DIN EN 1.4305 / AISI 303)
Execution: Hexagonal design
Operation temperature: -60 °C / +300 °C



Gewinde metrisch

Metric thread

G	 mm	M mm	i info	Art.-No.	
M8x1.25	11	2.8	1	8008.96	50
M10x1.5	13	2.8	1	8010.96	50
M12x1.5	17	3.0	-	8012.96	50
M16x1.5	19	3.0	-	8017.96	50
M20x1.5	24	3.5	-	8020.96	50
M25x1.5	30	3.5	-	8025.96	25
M32x1.5	36	4.5	-	8032.96	25
M40x1.5	46	4.5	-	8040.96	10
M50x1.5	55	5.5	-	8050.96	10
M63x1.5	70	6.0	-	8063.96	5

1 = Metrisches Regelgewinde

1 = Metric coarse-pitch thread



Gewinde Pg



Pg thread

G	 mm	M mm	Art.-No.	
Pg 7	17	3.5	8007.96	50
Pg 9	19	3.5	8009.96	50
Pg 11	22	3.5	8011.96	50
Pg 13	24	4.0	8013.96	50
Pg 16	27	4.0	8016.96	50
Pg 21	32	4.5	8021.96	25
Pg 29	41	5.5	8029.96	10
Pg 36	51	6.0	8036.96	10

Rostfreier und säurebeständiger Stahl A4 | Stainless steel and acid resistant A4

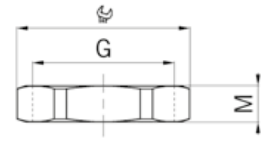
Material:	Rostfreier und säurebeständiger CrNiMo-Stahl A4 (DIN EN 1.4435 / AISI 316L)	Material:	Stainless steel and acid resistant steel A4 CrNiMo (DIN EN 1.4435 / AISI 316L)
Ausführung:	6-kant	Execution:	Hexagonal design
Einsatztemperatur:	-60 °C / +300 °C	Operation temperature:	-60 °C / +300 °C



Gewinde metrisch				Metric thread		
G	 mm	M mm	i info	Art.-No.		
M8x1.25	11	2.8	1	8008.98	50	
M10x1.5	13	2.8	1	8010.98	50	
M12x1.5	17	3.0	-	8012.98	50	
M16x1.5	19	3.0	-	8017.98	50	
M20x1.5	24	3.5	-	8020.98	50	
M25x1.5	30	3.5	-	8025.98	25	
M32x1.5	36	4.5	-	8032.98	25	
M40x1.5	46	4.5	-	8040.98	10	
M50x1.5	55	5.5	-	8050.98	10	
M63x1.5	70	6.0	-	8063.98	5	

1 = Metrisches Regelgewinde 1 = Metric coarse-pitch thread

1
2
3
4
5
6
7
8
9
10
11
12
13
14
15

Gegenmutter Kunststoff

Synthetic lock nuts

Anschlussgewinde metrisch | Entry thread metric

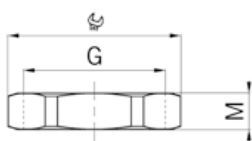

Material: Polyamid glasfaserverstärkt
 Eigenschaften: halogenfrei
 Ausführung: 6-kant
 Einsatztemperatur: -40 °C / +100 °C

Material: Polyamide glass fiber reinforced
 Properties: halogen-free
 Execution: Hexagonal design
 Operation temperature: -40 °C / +100 °C



Hellgrau RAL 7035

Light grey RAL 7035

G	 mm	M mm	Art.-No.	
M12x1.5	17	5.5	8212	100
M16x1.5	22	5.5	8217	100
M20x1.5	26	6.5	8220	100
M25x1.5	32	7.0	8225	100
M32x1.5	41	7.0	8232	100
M40x1.5	50	7.0	8240	50
M50x1.5	60	8.5	8250	10



Schwarz RAL 9005

Black RAL 9005



G	 mm	M mm	Art.-No.	
M12x1.5	17	5.5	8212.40	100
M16x1.5	22	5.5	8217.40	100
M20x1.5	26	6.5	8220.40	100
M25x1.5	32	7.0	8225.40	100
M32x1.5	41	7.0	8232.40	100
M40x1.5	50	7.0	8240.40	50
M50x1.5	60	8.5	8250.40	10

Anschlussgewinde Pg | Entry thread Pg

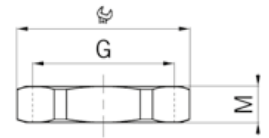

Material: Polyamid glasfaserverstärkt
 Eigenschaften: halogenfrei
 Ausführung: 6-kant
 Einsatztemperatur: -40 °C / +100 °C

Material: Polyamide glass fiber reinforced
 Properties: halogen-free
 Execution: Hexagonal design
 Operation temperature: -40 °C / +100 °C



Hellgrau RAL 7035			Light grey RAL 7035		
G	 mm	M mm	Art.-No.		
Pg 7	19	5.0	8207	100	
Pg 9	22	6.0	8209	100	
Pg 11	24	6.0	8211	100	
Pg 13	27	6.0	8213	100	
Pg 16	30	6.0	8216	100	
Pg 21	36	7.0	8221	100	
Pg 29	46	7.0	8229	50	
Pg 36	60	8.0	8236	25	
Pg 42	65	8.0	8242	25	
Pg 48	70	8.0	8248.48	25	



Schwarz RAL 9005			Black RAL 9005		
G	 mm	M mm	Art.-No.		
Pg 7	19	5.0	8207.40	100	
Pg 9	22	6.0	8209.40	100	
Pg 11	24	6.0	8211.40	100	
Pg 13	27	6.0	8213.40	100	
Pg 16	30	6.0	8216.40	100	
Pg 21	36	7.0	8221.40	100	
Pg 29	46	7.0	8229.40	50	
Pg 36	60	8.0	8236.40	25	
Pg 42	65	8.0	8242.40	25	
Pg 48	70	8.0	8248.48.40	25	



1
2
3
4
5
6
7
8
9
10
11
12
13
14
15

Gegenmutter Kunststoff mit Flansch

Synthetic lock nuts with flange

Anschlussgewinde metrisch | Entry thread metric

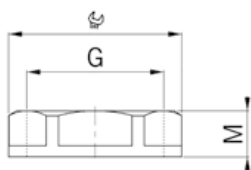

Material: Polyamid PA 6
 Eigenschaften: halogenfrei
 Ausführung: 6-kant mit Flansch
 Einsatztemperatur: -30 °C / +100 °C

Material: Polyamide PA 6
 Properties: halogen-free
 Execution: Hexagonal design with flange
 Operation temperature: -30 °C / +100 °C



Hellgrau RAL 7035

Light grey RAL 7035

G	 mm	M mm	Art.-No.	
M12x1.5	17	5.0	8255.12	100
M16x1.5	22	5.0	8255.17	100
M20x1.5	27	6.0	8255.20	100
M25x1.5	33	6.7	8255.25	100
M32x1.5	42	7.9	8255.32	50
M40x1.5	48	8.4	8255.40	50
M50x1.5	59	9.9	8255.50	10
M63x1.5	73	11.0	8255.63	10



Schwarz RAL 9005

Black RAL 9005



G	 mm	M mm	Art.-No.	
M12x1.5	17	5.0	8245.12	100
M16x1.5	22	5.0	8245.17	100
M20x1.5	27	6.0	8245.20	100
M25x1.5	33	6.7	8245.25	100
M32x1.5	42	7.9	8245.32	50
M40x1.5	48	8.4	8245.40	50
M50x1.5	59	9.9	8245.50	10
M63x1.5	73	11.0	8245.63	10

Anschlussgewinde Pg | Entry thread Pg

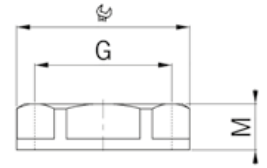

Material: Polyamid PA 6
 Eigenschaften: halogenfrei
 Ausführung: 6-kant mit Flansch
 Einsatztemperatur: -30 °C / +100 °C

Material: Polyamide PA 6
 Properties: halogen-free
 Execution: Hexagonal design with flange
 Operation temperature: -30 °C / +100 °C



Hellgrau RAL 7035			Light grey RAL 7035		
G	 mm	M	Art.-No.		
Pg 7	19	5.0	8255.07	100	
Pg 9	21	5.0	8255.09	100	
Pg 11	24	5.0	8255.11	100	
Pg 13	27	6.0	8255.13	100	
Pg 16	30	6.0	8255.16	100	
Pg 21	36	7.0	8255.21	50	
Pg 29	46	8.0	8255.29	25	
Pg 36	59	8.0	8255.36	25	
Pg 42	65	8.0	8255.42	10	
Pg 48	69	8.0	8255.48	10	



Schwarz RAL 9005			Black RAL 9005		
G	 mm	M	Art.-No.		
Pg 7	19	5.0	8245.07	100	
Pg 9	21	5.0	8245.09	100	
Pg 11	24	5.0	8245.11	100	
Pg 13	27	6.0	8245.13	100	
Pg 16	30	6.0	8245.16	100	
Pg 21	36	7.0	8245.21	50	
Pg 29	46	8.0	8245.29	50	
Pg 36	59	8.0	8245.36	25	
Pg 42	65	8.0	8245.42	10	
Pg 48	69	8.0	8245.48	10	



1
2
3
4
5
6
7
8
9
10
11
12
13
14
15

Reduktionen Messing

Reduction fittings nickel-plated brass

mit 6-kant | hexagonal

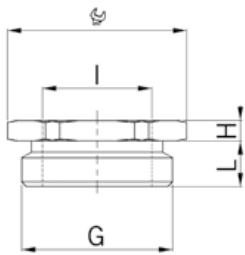



Material: Messing vernickelt
 O-Ring: NBR
 Schutzart: IP 68
 Einsatztemperatur: -40 °C / +100 °C

Material: Nickel-plated brass
 O-ring: NBR
 Protection class: IP 68
 Operation temperature: -40 °C / +100 °C



Aussengewinde metrisch
 Innengewinde metrisch
 mit O-Ring

Outer thread metric
 Inner thread metric
 with O-ring

G	I	 mm	H mm	L mm	i info	Art.-No.	
M 8x1.25	M 6x1.0	11	8.0	5	1	3500.08.06	50
M10x1.5	M 6x1.0	13	3.0	5	1	3500.10.06	50
M10x1.5	M 8x1.25	13	8.0	5	1	3500.10.08	50
M12x1.5	M 8x1.25	15	3.0	5	1	3500.12.08	50
M12x1.5	M10x1.5	15	8.0	5	1	3500.12.10	50
M16x1.5	M10x1.5	18	3.0	5	1	3500.17.10	50
M16x1.5	M12x1.5	18	3.0	5	-	3500.17.12	50
M20x1.5	M12x1.5	24	3.0	6	-	3500.20.12	50
M20x1.5	M16x1.5	24	3.0	6	-	3500.20.17	50
M25x1.5	M16x1.5	30	3.5	7	-	3500.25.17	25
M25x1.5	M20x1.5	30	3.5	7	-	3500.25.20	25
M32x1.5	M20x1.5	36	4.0	8	-	3500.32.20	20
M32x1.5	M25x1.5	36	4.0	8	-	3500.32.25	20
M40x1.5	M25x1.5	46	4.5	8	-	3500.40.25	10
M40x1.5	M32x1.5	46	4.5	8	-	3500.40.32	10
M50x1.5	M32x1.5	55	5.0	9	-	3500.50.32	10
M50x1.5	M40x1.5	55	5.0	9	-	3500.50.40	10
M63x1.5	M40x1.5	70	5.5	10	-	3500.63.40	5
M63x1.5	M50x1.5	70	5.5	10	-	3500.63.50	5
M75x1.5	M50x1.5	80	6.0	11	-	3500.75.50	5
M75x1.5	M63x1.5	80	6.0	11	-	3500.75.63	5

1 = Metrisches Regelgewinde

1 = Metric coarse-pitch thread

Runde Bauform, randriert | Round, knurled

Material: Messing vernickelt
Schutzart: IP 54
Gewinde: IP 68, wenn Anschlussge-
winde abgedichtet
Einsatztemperatur: -40 °C / +200 °C

Material: Nickel-plated brass
Protection class: IP 54
Entry thread: IP 68, if the entry thread is
sealed
Operation temperature: -40 °C / +200 °C

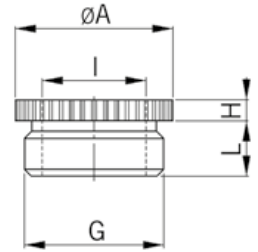

Aussengewinde metrisch
Innengewinde metrisch
ohne O-Ring

Outer thread metric
Inner thread metric
without O-Ring

G	I	øA mm	H mm	L mm	Art.-No.	
M16x1.5	M12x1.5	18	3	7	3545.17.12	100
M20x1.5	M12x1.5	22	3	8	3545.20.12	100
M20x1.5	M16x1.5	22	3	8	3545.20.17	100
M25x1.5	M16x1.5	27	3	8	3545.25.17	50
M25x1.5	M20x1.5	27	3	8	3545.25.20	50
M32x1.5	M20x1.5	34	4	9	3545.32.20	50
M32x1.5	M25x1.5	34	4	9	3545.32.25	50
M40x1.5	M25x1.5	42	4.5	9	3545.40.25	50
M40x1.5	M32x1.5	42	4.5	9	3545.40.32	25
M50x1.5	M32x1.5	52	4.5	10	3545.50.32	25
M50x1.5	M40x1.5	52	4.5	10	3545.50.40	10
M63x1.5	M40x1.5	65	5	11	3545.63.40	10
M63x1.5	M50x1.5	65	5	11	3545.63.50	10

mit 6-kant | hexagonal

Material: Messing vernickelt
O-Ring: NBR
Schutzart: IP 68
Einsatztemperatur: -40 °C / +100 °C

Material: Nickel-plated brass
O-ring: NBR
Protection class: IP 68
Operation temperature: -40 °C / +100 °C

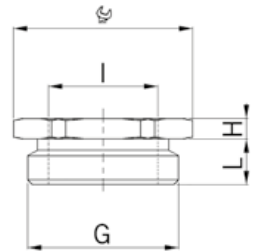

Aussengewinde Pg
Innengewinde Pg
mit O-Ring

Outer thread Pg
Inner thread Pg
with O-ring

G	I	 mm	H mm	L mm	Art.-No.	
Pg 9	Pg 7	18	3.0	6.5	3509.07	50
Pg 11	Pg 7	20	3.0	6.5	3511.07	50
Pg 11	Pg 9	22	3.0	7.0	3511.09	50
Pg 13	Pg 7	24	3.0	7.0	3513.07	50
Pg 13	Pg 9	24	3.0	7.0	3513.09	50
Pg 13	Pg 11	24	3.0	7.0	3513.11	50
Pg 16	Pg 9	24	3.0	7.0	3516.09	50
Pg 16	Pg 11	24	3.0	7.0	3516.11	50
Pg 16	Pg 13	27	3.0	7.0	3516.13	50
Pg 21	Pg 11	32	3.5	7.5	3521.11	25
Pg 21	Pg 13	32	3.5	7.5	3521.13	25
Pg 21	Pg 16	32	3.5	7.5	3521.16	25
Pg 29	Pg 13	38	4.0	8.0	3529.13	10
Pg 29	Pg 16	38	4.0	8.0	3529.16	10
Pg 29	Pg 21	38	4.0	8.0	3529.21	10
Pg 36	Pg 21	50	4.5	8.5	3536.21	10
Pg 36	Pg 29	50	4.5	8.5	3536.29	10
Pg 42	Pg 29	60	4.0	11.0	3542.29	10
Pg 42	Pg 36	60	4.0	11.0	3542.36	10
Pg 48	Pg 36	65	4.0	11.0	3548.48.36	10

1
2
3
4
5
6
7
8
9
10
11
12
13
14
15

Erweiterungen Messing

Enlarging fittings nickel-plated brass

mit 6-kant | hexagonal

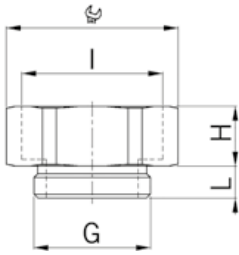



Material: Messing vernickelt
 O-Ring: NBR
 Schutzart: IP 68
 Einsatztemperatur: -40 °C / +100 °C

Material: Nickel-plated brass
 O-ring: NBR
 Protection class: IP 68
 Operation temperature: -40 °C / +100 °C



Aussengewinde metrisch
 Innengewinde metrisch
 mit O-Ring

Outer thread metric
 Inner thread metric
 with O-ring

G	I	 mm	H mm	L mm	i info	Art.-No.	
M 6x1.0	M 8x1.25	11	8.5	5	1	3600.06.08	50
M 6x1.0	M10x1.5	13	8.5	5	1	3600.06.10	50
M 8x1.25	M10x1.5	13	9	5	1	3600.08.10	50
M 8x1.25	M12x1.5	15	9	5	1	3600.08.12	50
M10x1.5	M12x1.5	15	9	5	1	3600.10.12	50
M10x1.5	M16x1.5	18	9	5	1	3600.10.17	50
M12x1.5	M16x1.5	18	9	5	-	3600.12.17	50
M12x1.5	M20x1.5	24	10	5	-	3600.12.20	50
M16x1.5	M20x1.5	24	10	5	-	3600.17.20	50
M20x1.5	M25x1.5	30	11.5	6	-	3600.20.25	25
M25x1.5	M32x1.5	36	14	7	-	3600.25.32	25
M32x1.5	M40x1.5	46	14	8	-	3600.32.40	25
M40x1.5	M50x1.5	55	16	8	-	3600.40.50	10
M50x1.5	M63x1.5	70	17	9	-	3600.50.63	10
M63x1.5	M75x1.5	80	18	10	-	3600.63.75	10

1 = Metrisches Regelgewinde

1 = Metric coarse-pitch thread

Runde Bauform | Round execution

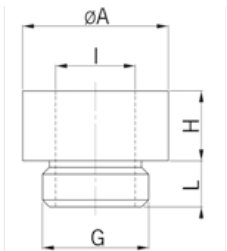

Material: Messing vernickelt
 Schutzart: IP 54
 Gewinde: IP 68, wenn Anschluss-
 gewinde abgedichtet
 Einsatztemperatur: -40 °C / +200 °C

Material: Nickel-plated brass
 Protection class: IP 54
 Entry thread: IP 68, if the entry thread
 is sealed
 Operation temperature: -40 °C / +200 °C



Aussengewinde metrisch
 Innengewinde metrisch
 ohne O-Ring

Outer thread metric
 Inner thread metric
 without O-Ring

G	I	ØA mm	H mm	L mm	Art.-No.	
M12x1.5	M16x1.5	19	9.5	6.5	3645.12.17	100
M16x1.5	M20x1.5	22	10.5	7	3645.17.20	100
M20x1.5	M25x1.5	27	11	8	3645.20.25	100
M25x1.5	M32x1.5	34	12	8	3645.25.32	50
M32x1.5	M40x1.5	42	12	9	3645.32.40	50
M40x1.5	M50x1.5	53	14	9	3645.40.50	25
M50x1.5	M63x1.5	66	19	10	3645.50.63	25

mit 6-kant | hexagonal

Material: Messing vernickelt
O-Ring: NBR
Schutzart: IP 68
Einsatztemperatur: -40 °C / +100 °C

Material: Nickel-plated brass
O-ring: NBR
Protection class: IP 68
Operation temperature: -40 °C / +100 °C

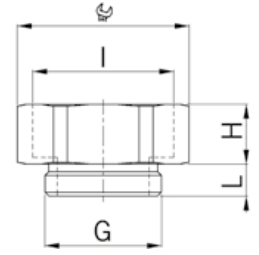

Aussengewinde Pg
Innengewinde Pg
mit O-Ring

Outer thread Pg
Inner thread Pg
with O-ring

G	I	 mm	H mm	L mm	Art.-No.	
Pg 7	Pg 9	18	13	8	3607.09.08	50
Pg 9	Pg 11	22	15	8	3609.11.08	50
Pg 9	Pg 13	24	15	8	3609.13.08	50
Pg 11	Pg 13	24	15	8	3611.13.08	50
Pg 11	Pg 16	24	15	8	3611.16.08	50
Pg 11	Pg 21	32	16	8	3611.21.08	50
Pg 13	Pg 16	24	15	8	3613.16.08	50
Pg 13	Pg 21	32	16	8	3613.21.08	25
Pg 16	Pg 21	32	16	8	3616.21.08	25
Pg 16	Pg 29	40	16	8	3616.29.08	25
Pg 21	Pg 29	40	16	8	3621.29.08	25
Pg 29	Pg 36	50	18	10	3629.36.08	20
Pg 36	Pg 42	60	19	12	3636.42.08	10
Pg 36	Pg 48	64	20	12	3636.48.48.08	10

1
2
3
4
5
6
7
8
9
10
11
12
13
14
15

Adapter Messing

Adapter nickel-plated brass

mit 6-kant | hexagonal

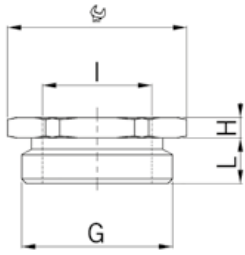

Material: Messing vernickelt
 O-Ring: NBR
 Schutzart: IP 68
 Einsatztemperatur: -40 °C / +100 °C

Material: Nickel-plated brass
 O-ring: NBR
 Protection class: IP 68
 Operation temperature: -40 °C / +100 °C



Aussengewinde metrisch
 Innengewinde Pg
 mit O-Ring

Outer thread metric
 Inner thread Pg
 with O-ring

G	I	 mm	H mm	L mm	Art.-No.	
M16x1.5	Pg 7	20	3.0	5	3500.17.07	50
M20x1.5	Pg 7	24	3.0	6	3500.20.07	50
M20x1.5	Pg 9	24	3.0	6	3500.20.09	50
M20x1.5	Pg 11	24	10.0	6	3500.20.11	50
M25x1.5	Pg 9	30	3.5	7	3500.25.09	50
M25x1.5	Pg 11	30	3.5	7	3500.25.11	50
M25x1.5	Pg 13	30	3.8	7	3500.25.13	50
M25x1.5	Pg 16	30	15.0	7	3500.25.16	25
M32x1.5	Pg 21	38	16.0	8	3500.32.21	25
M40x1.5	Pg 29	45	16.0	8	3500.40.29	10
M50x1.5	Pg 29	55	4.0	9	3500.50.29	10
M63x1.5	Pg 36	70	5.5	10	3500.63.36	10

mit 6-kant | hexagonal



Aussengewinde metrisch
 Innengewinde Pg
 mit O-Ring

Outer thread metric
 Inner thread Pg
 with O-ring

G	I	 mm	H mm	L mm	i info	Art.-No.	
M10x1.5	Pg 7	16	12	5	1	3600.10.07	50
M10x1.5	Pg 9	18	12	5	1	3600.10.09	50
M12x1.5	Pg 9	18	12	5	-	3600.12.09	50
M16x1.5	Pg 11	22	14	5	-	3600.17.11	50
M20x1.5	Pg 13	24	15	6	-	3600.20.13	50
M20x1.5	Pg 16	24	15	6	-	3600.20.16	50
M25x1.5	Pg 21	32	16	7	-	3600.25.21	25
M32x1.5	Pg 29	40	16	8	-	3600.32.29	25
M40x1.5	Pg 36	50	18	8	-	3600.40.36	20
M50x1.5	Pg 42	60	19	9	-	3600.50.42	10
M50x1.5	Pg 48	64	20	9	-	3600.50.48	10

1 = Metrisches Regelgewinde

1 = Metric coarse-pitch thread

mit 6-kant | hexagonal

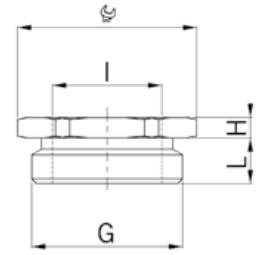

Material: Messing vernickelt
O-Ring: NBR
Schutzart: IP 68
Einsatztemperatur: -40 °C / +100 °C

Material: Nickel-plated brass
O-ring: NBR
Protection class: IP 68
Operation temperature: -40 °C / +100 °C



Aussengewinde Pg
Innengewinde metrisch
mit O-Ring

Outer thread Pg
Inner thread metric
with O-ring

G	I	 mm	H mm	L mm	i info	Art.-No.	
Pg 7	M 6x1.0	15	3.0	6	1	3500.07.06	50
Pg 7	M 8x1.25	15	3.0	6	1	3500.07.08	50
Pg 7	M 10x1.5	15	7.0	6	1	3500.07.10	50
Pg 9	M 6x1.0	18	3.0	6	1	3500.09.06	50
Pg 9	M 8x1.25	18	3.0	6	1	3500.09.08	50
Pg 9	M 10x1.5	18	3.0	6	1	3500.09.10	50
Pg 9	M 12x1.5	18	8.0	6	-	3500.09.12	50
Pg 11	M 6x1.0	21	3.0	6	1	3500.11.06	50
Pg 11	M 8x1.25	21	3.0	6	1	3500.11.08	50
Pg 11	M 10x1.5	21	3.0	6	1	3500.11.10	50
Pg 11	M 12x1.5	21	3.0	6	-	3500.11.12	50
Pg 11	M 16x1.5	21	8.0	6	-	3500.11.17	50
Pg 13	M 12x1.5	24	3.0	6	-	3500.13.12	50
Pg 13	M 16x1.5	24	3.0	6	-	3500.13.17	50
Pg 16	M 12x1.5	24	3.0	6	-	3500.16.12	25
Pg 16	M 16x1.5	24	3.0	6	-	3500.16.17	25
Pg 16	M 20x1.5	24	10.5	6	-	3500.16.20	25
Pg 21	M 16x1.5	30	3.5	7.5	-	3500.21.17	25
Pg 21	M 20x1.5	30	3.5	7.5	-	3500.21.20	25
Pg 21	M 25x1.5	30	10.5	7.5	-	3500.21.25	25
Pg 29	M 25x1.5	38	4.0	8	-	3500.29.25	20
Pg 29	M 32x1.5	38	13.0	8	-	3500.29.32	20
Pg 36	M 32x1.5	50	4.5	8	-	3500.36.32	10
Pg 36	M 40x1.5	50	4.5	8	-	3500.36.40	10
Pg 42	M 32x1.5	55	5.0	10	-	3500.42.32	10
Pg 42	M 40x1.5	55	5.0	10	-	3500.42.40	10
Pg 42	M 50x1.5	55	15.0	10	-	3500.42.50	10
Pg 48	M 40x1.5	65	5.5	11	-	3500.48.40	5
Pg 48	M 50x1.5	65	5.5	11	-	3500.48.50	5

1 = Metrisches Regelgewinde

1 = Metric coarse-pitch thread

1
2
3
4
5
6
7
8
9
10
11
12
13
14
15

Adapter Messing

Adapter nickel-plated brass

mit 6-kant | hexagonal

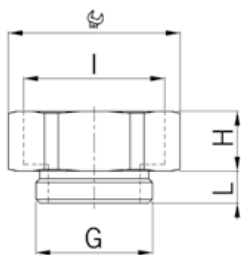



Material: Messing vernickelt
 O-Ring: NBR
 Schutzart: IP 68
 Einsatztemperatur: -40 °C / +100 °C

Material: Nickel-plated brass
 O-ring: NBR
 Protection class: IP 68
 Operation temperature: -40 °C / +100 °C



Aussengewinde Pg
 Innengewinde metrisch
 mit O-Ring

Outer thread Pg
 Inner thread metric
 with O-ring

G	I	 mm	H mm	L mm	Art.-No.	
Pg 7	M12x1.5	15	9.0	6	3600.07.12	50
Pg 7	M16x1.5	18	9.0	6	3600.07.17	50
Pg 9	M16x1.5	18	9.5	6	3600.09.17	50
Pg 9	M20x1.5	24	10.5	6	3600.09.20	50
Pg 11	M20x1.5	24	10.5	6	3600.11.20	50
Pg 11	M25x1.5	30	11.5	6	3600.11.25	25
Pg 13	M20x1.5	24	10.5	6	3600.13.20	50
Pg 13	M25x1.5	30	11.5	6	3600.13.25	25
Pg 16	M25x1.5	30	11.5	6	3600.16.25	25
Pg 16	M32x1.5	36	13.5	6	3600.16.32	25
Pg 21	M32x1.5	36	14.0	7.5	3600.21.32	25
Pg 21	M40x1.5	46	14.0	7.5	3600.21.40	20
Pg 29	M40x1.5	46	14.0	8	3600.29.40	20
Pg 29	M50x1.5	55	16.0	8	3600.29.50	10
Pg 36	M50x1.5	55	16.0	8	3600.36.50	10
Pg 36	M63x1.5	70	17.0	8	3600.36.63	10
Pg 42	M63x1.5	70	17.0	10	3600.42.63	10
Pg 42	M75x1.5	80	18.0	10	3600.42.75	10
Pg 48	M63x1.5	70	17.0	11	3600.48.63	10
Pg 48	M75x1.5	80	18.0	11	3600.48.75	10

Runde Bauform, randriert | Round, knurled

Material: Messing vernickelt
 Schutzart: IP 54
 Gewinde: IP 68, wenn Anschluss-
 gewinde abgedichtet
 Einsatztemperatur: -40 °C / +200 °C

Material: Nickel-plated brass
 Protection class: IP 54
 Entry thread: IP 68, if the entry thread
 is sealed
 Operation temperature: -40 °C / +200 °C

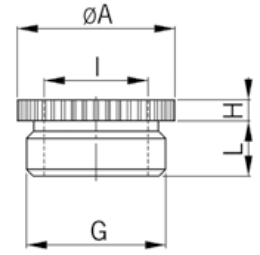

Aussengewinde Pg
 Innengewinde metrisch
 ohne O-Ring

Outer thread Pg
 Inner thread metric
 without O-Ring

G	I	øA mm	H mm	L mm	Art.-No.	
Pg 11	M16x1.5	20	10	6	3545.11.17	50
Pg 16	M20x1.5	24	11	6	3545.16.20	50
Pg 21	M20x1.5	30	3.5	7.5	3545.21.20	50
Pg 21	M25x1.5	30	11	7.5	3545.21.25	50
Pg 29	M25x1.5	39	4	8	3545.29.25	25
Pg 29	M32x1.5	39	4	8	3545.29.32	25
Pg 36	M40x1.5	50	4.5	8	3545.36.40	10



Runde Bauform | Round execution

Material: Messing vernickelt
 Schutzart: IP 54
 Gewinde: IP 68, wenn Anschluss-
 gewinde abgedichtet
 Einsatztemperatur: -40 °C / +200 °C

Material: Nickel-plated brass
 Protection class: IP 54
 Entry thread: IP 68, if the entry thread
 is sealed
 Operation temperature: -40 °C / +200 °C

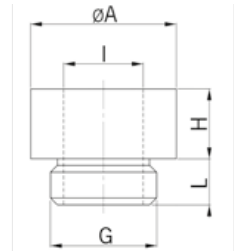

Aussengewinde Pg
 Innengewinde metrisch
 ohne O-Ring

Outer thread Pg
 Inner thread metric
 without O-Ring

G	I	øA mm	H mm	L mm	Art.-No.	
Pg 7	M12x1.5	14	9	6	3645.07.12	100
Pg 9	M16x1.5	19	9.5	6	3645.09.17	50
Pg 11	M20x1.5	22	11	6	3645.11.20	50
Pg 13	M20x1.5	22	11	6	3645.13.20	50
Pg 16	M25x1.5	27	11	6	3645.16.25	50
Pg 21	M32x1.5	34	12	7.5	3645.21.32	50
Pg 29	M40x1.5	42	12	8	3645.29.40	10



1
2
3
4
5
6
7
8
9
10
11
12
13
14
15

Adapter Messing

Adapter nickel-plated brass

mit 6-kant | hexagonal

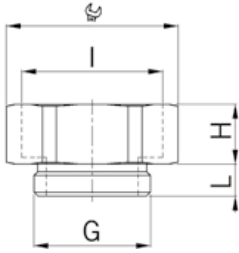

Material: Messing vernickelt
 O-Ring: NBR
 Schutzart: IP 68
 Einsatztemperatur: -40 °C / +100 °C

Material: Nickel-plated brass
 O-ring: NBR
 Protection class: IP 68
 Operation temperature: -40 °C / +100 °C



Aussengewinde Pg
 Innengewinde Gasrohr
 mit O-Ring

Outer thread Pg
 Inner thread gas-pipe
 with O-ring

G	I		H	L	Art.-No.	
		mm	mm	mm		
Pg 13	G3/8"	24	3	7	35133/8G	50
Pg 16	G1/2"	24	14	10	36161/2G.08	50
Pg 21	G3/4"	32	14	12	36213/4G.08	25
Pg 36	G 2"	64	20	12	3636.48.08	10
Pg 42	G 2"	64	20	15	3642.48.08	10



Aussengewinde Gasrohr
 Innengewinde Pg
 mit O-Ring

Outer thread gas-pipe
 Inner thread Pg
 with O-ring

G	I		H	L	Art.-No.	
		mm	mm	mm		
G3/8"	Pg 7	20	3	10	353/8G.07	50
G1/2"	Pg 9	24	3	9.5	351/2G.09	50
G3/4"	Pg 9	30	3.5	11	353/4G.09	50
G3/4"	Pg 11	30	3.5	11	353/4G.11	50
G3/4"	Pg 16	32	3.5	11	353/4G.16	50
G 1"	Pg 21	38	3.5	11	351G.21	25
G 1 1/4"	Pg 29	50	5	11	3511/4G.29	25
G 2"	Pg 36	64	5	11	352G.36	10
G 2"	Pg 42	64	5	11	352G.42	10



Aussengewinde Gasrohr
 Gewinde innen Pg
 mit O-Ring

Outer thread gas-pipe
 Inner thread Pg
 with O-ring

G	I		H	L	Art.-No.	
		mm	mm	mm		
G3/8"	Pg 11	20	12	10	363/8G.11.08	50
G1/2"	Pg 11	24	12	10	361/2G.11.08	50
G1/2"	Pg 13	24	12	10	361/2G.13.08	50
G1/2"	Pg 16	24	12	10	361/2G.16.08	50
G5/8"	Pg 16	24	12	10	365/8G.16.08	50
G3/4"	Pg 21	32	15	12	363/4G.21.08	25
G7/8"	Pg 29	41	15	12	367/8G.29.08	25
G 1"	Pg 29	41	15	11	361G.29.08	25
G 1 1/2"	Pg 36	54	22	12	3611/2G.36.08	10

mit 6-kant | hexagonal

Material: Messing vernickelt
 Gewinde: IP 68, wenn Anschluss-
 gewinde abgedichtet
 Einsatztemperatur: -40 °C / +100 °C

Material: Nickel-plated brass
 Entry thread: IP 68, if the entry thread
 is sealed
 Operation temperature: -40 °C / +100 °C

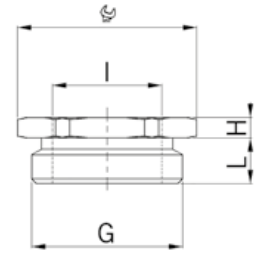

Aussengewinde NPT
 Innengewinde Pg
 ohne O-Ring

Outer thread NPT
 Inner thread Pg
 without O-Ring

G	I	 mm	H mm	L mm	Art.-No.	
NPT1/2"	Pg 9	22	4.5	20	351/2NPT.09	50
NPT3/4"	Pg 11	30	4	20	353/4NPT.11	10
NPT3/4"	Pg 13	30	4	20	353/4NPT.13	10
NPT 1"	Pg 16	36	6	26	351NPT.16	10



mit 6-kant | hexagonal

Material: Messing vernickelt
 O-Ring: NBR
 Gewinde: IP 68, wenn Anschluss-
 gewinde abgedichtet
 Einsatztemperatur: -40 °C / +100 °C

Material: Nickel-plated brass
 O-ring: NBR
 Entry thread: IP 68, if the entry thread
 is sealed
 Operation temperature: -40 °C / +100 °C

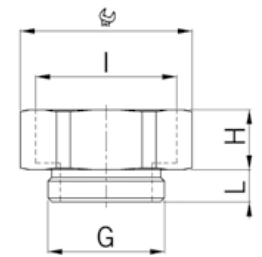

Aussengewinde NPT
 Innengewinde Pg
 ohne O-Ring

Outer thread NPT
 Inner thread Pg
 without O-Ring

G	I	 mm	H mm	L mm	Art.-No.	
NPT1/2"	Pg 11	24	12	20	361/2NPT.11	50
NPT1/2"	Pg 13	24	14	20	361/2NPT.13	50
NPT1/2"	Pg 16	34	20	20	361/2NPT.16	50
NPT3/4"	Pg 21	32	14	20	363/4NPT.21	25



Reduktionen Kunststoff

Synthetic reduction fittings

mit 6-kant | hexagonal

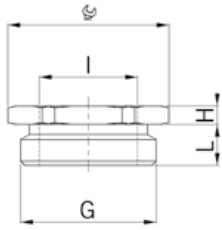



Material: Polyamid PA 6
 Eigenschaften: halogenfrei
 Schutzart: IP 54
 Gewinde: IP 68, wenn Anschluss-
 gewinde abgedichtet
 Einsatztemperatur: -30 °C / +100 °C

Material: Polyamide PA 6
 Properties: halogen-free
 Protection class: IP 54
 Entry thread: IP 68, if the entry thread
 is sealed
 Operation temperature: -30 °C / +100 °C



Aussengewinde metrisch
 Innengewinde metrisch
 Hellgrau RAL 7035

Outer thread metric
 Inner thread metric
 Light grey RAL 7035

G	I	 mm	H mm	L mm	Art.-No.	
M16x1.5	M12x1.5	22	4	8	3455.17.12	100
M20x1.5	M12x1.5	24	4	8	3455.20.12	100
M20x1.5	M16x1.5	24	4	8	3455.20.17	100
M25x1.5	M12x1.5	29	6	8	3455.25.12	100
M25x1.5	M16x1.5	29	6	8	3455.25.17	100
M25x1.5	M20x1.5	29	6	8	3455.25.20	100
M32x1.5	M12x1.5	36	6	10	3455.32.12	50
M32x1.5	M16x1.5	36	6	10	3455.32.17	50
M32x1.5	M20x1.5	36	6	10	3455.32.20	50
M32x1.5	M25x1.5	36	6	10	3455.32.25	50
M40x1.5	M16x1.5	46	6	10	3455.40.17	50
M40x1.5	M20x1.5	46	6	10	3455.40.20	50
M40x1.5	M25x1.5	46	6	10	3455.40.25	25
M40x1.5	M32x1.5	46	6	10	3455.40.32	25
M50x1.5	M20x1.5	55	6	12	3455.50.20	5
M50x1.5	M25x1.5	55	6	12	3455.50.25	5
M50x1.5	M32x1.5	55	6	12	3455.50.32	5
M50x1.5	M40x1.5	55	6	12	3455.50.40	5
M63x1.5	M25x1.5	68	6	12	3455.63.25	5
M63x1.5	M32x1.5	68	6	12	3455.63.32	5
M63x1.5	M40x1.5	68	6	12	3455.63.40	5
M63x1.5	M50x1.5	68	6	12	3455.63.50	5

mit 6-kant | hexagonal

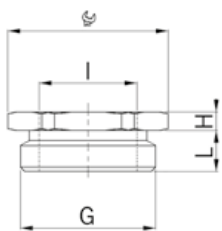

Material: Polyamid glasfaserverstärkt
 Schutzart: IP 54
 Gewinde: IP 68, wenn Anschluss-
 gewinde abgedichtet
 Einsatztemperatur: -20 °C / +100 °C

Material: Polyamide glass fiber
 reinforced
 Protection class: IP 54
 Entry thread: IP 68, if the entry thread
 is sealed
 Operation temperature: -20 °C / +100 °C



Aussengewinde Pg
 Innengewinde Pg
 Hellgrau

Outer thread Pg
 Inner thread Pg
 Light grey

G	I	 mm	H mm	L mm	Art.-No.	
Pg 9	Pg 7	19	12	8	3409.07	50
Pg 11	Pg 7	22	3	8	3411.07	50
Pg 11	Pg 9	22	15	8	3411.09	50
Pg 13	Pg 9	24	3	9	3413.09	50
Pg 13	Pg 11	24	15	9	3413.11	50
Pg 16	Pg 9	27	5	9	3416.09	50
Pg 16	Pg 11	27	5	9	3416.11	50
Pg 16	Pg 13	27	17	10	3416.13	50
Pg 21	Pg 13	32	5	11	3421.13	25
Pg 21	Pg 16	32	5	11	3421.16	25
Pg 29	Pg 21	41	6	12	3429.21	10
Pg 36	Pg 29	50	6	14	3436.29	10

rund mit 6-kant | round with hexagon

Material: Polyamid PA 6
Eigenschaften: halogenfrei
Schutzart: IP 54
Gewinde: IP 68, wenn Anschluss-
gewinde abgedichtet
Einsatztemperatur: -30 °C / +100 °C

Material: Polyamide PA 6
Properties: halogen-free
Protection class: IP 54
Entry thread: IP 68, if the entry thread
is sealed
Operation temperature: -30 °C / +100 °C

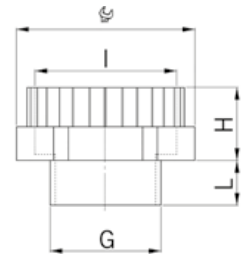

Aussengewinde metrisch
Innengewinde metrisch
Hellgrau RAL 7035

Outer thread metric
Inner thread metric
Light grey RAL 7035

G	I	 mm	H mm	L mm	Art.-No.	
M12x1.5	M16x1.5	20	13	8	3755.12.17	100
M16x1.5	M20x1.5	24	13	8	3755.17.20	100
M20x1.5	M25x1.5	29	13	8	3755.20.25	100
M25x1.5	M32x1.5	36	15	8	3755.25.32	50
M32x1.5	M40x1.5	46	15	10	3755.32.40	25
M40x1.5	M50x1.5	55	15	10	3755.40.50	10
M50x1.5	M63x1.5	68	15	10	3755.50.63	10



rund mit 6-kant | round with hexagon

Material: Polyamid glasfaserverstärkt
Schutzart: IP 54
Gewinde: IP 68, wenn Anschluss-
gewinde abgedichtet
Einsatztemperatur: -20 °C / +100 °C

Material: Polyamide glass fiber
reinforced
Protection class: IP 54
Entry thread: IP 68, if the entry thread
is sealed
Operation temperature: -20 °C / +100 °C

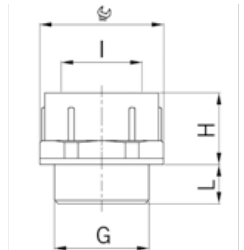

Aussengewinde Pg
Innengewinde Pg
Hellgrau

Outer thread Pg
Inner thread Pg
Light grey

G	I	 mm	H mm	L mm	Art.-No.	
Pg 7	Pg 9	19	18	7	3707.09	50
Pg 9	Pg 11	22	19	7	3709.11	50
Pg 11	Pg 13	24	21	8	3711.13	50
Pg 13	Pg 16	27	23	9	3713.16	50
Pg 16	Pg 21	32	26	9	3716.21	25
Pg 21	Pg 29	41	33	10	3721.29	25
Pg 29	Pg 36	55	39	12	3729.36	10
Pg 36	Pg 42	60	46	14	3736.42	10
Pg 42	Pg 48	65	39	16	3742.48	10



1
2
3
4
5
6
7
8
9
10
11
12
13
14
15

Adapter Kunststoff

Synthetic adapter

rund mit 6-kant | round with hexagon

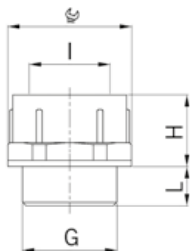

Material: Polyamid glasfaserverstärkt
 Schutzart: IP 54
 Gewinde: IP 68, wenn Anschluss-
 gewinde abgedichtet
 Einsatztemperatur: -20 °C / +100 °C

Material: Polyamide glass fiber
 reinforced
 Protection class: IP 54
 Entry thread: IP 68, if the entry thread
 is sealed
 Operation temperature: -20 °C / +100 °C



Aussengewinde metrisch
 Innengewinde Pg
 Hellgrau

Outer thread metric
 Inner thread Pg
 Light grey

G	I	 mm	H mm	L mm	Art.-No.	
M12x1.5	Pg 9	19	13	11	3712.09	50
M20x1.5	Pg 13	24	15	11	3720.13	50
M20x1.5	Pg 16	27	17	11	3720.16	50
M25x1.5	Pg 21	33	20	11	3725.21	25
M32x1.5	Pg 29	42	22	11	3732.29	25
M50x1.5	Pg 42	60	28	11	3750.42	10



Aussengewinde metrisch
 Innengewinde Pg
 Hellgrau

Outer thread metric
 Inner thread Pg
 Light grey

G	I	 mm	H mm	L mm	Art.-No.	
M16x1.5	Pg 9	19	14	11	3417.09	50
M20x1.5	Pg 11	22	16	11	3420.11	50
M25x1.5	Pg 16	27	18	11	3425.16	50
M40x1.5	Pg 29	42	23	11	3440.29	25
M50x1.5	Pg 36	53	26	11	3450.36	10
M63x1.5	Pg 48	65	29	11	3463.48	5

rund mit 6-kant | round with hexagon

Material: Polyamid PA 6
Eigenschaften: halogenfrei
Schutzart: IP 54
Gewinde: IP 68, wenn Anschluss-
gewinde abgedichtet
Einsatztemperatur: -30 °C / +100 °C

Material: Polyamide PA 6
Properties: halogen-free
Protection class: IP 54
Entry thread: IP 68, if the entry thread
is sealed
Operation temperature: -30 °C / +100 °C

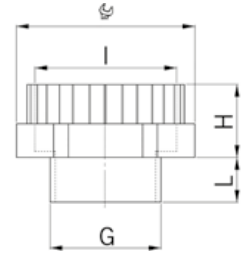

Aussengewinde Pg
Innengewinde metrisch
Hellgrau RAL 7035

Outer thread Pg
Inner thread metric
Light grey RAL 7035

G	I	 mm	H mm	L mm	Art.-No.	
Pg 7	M12x1.5	15	12	8	3755.07.12	100
Pg 7	M16x1.5	20	12	8	3755.07.17	100
Pg 9	M16x1.5	20	12	8	3755.09.17	100
Pg 9	M20x1.5	24	12	8	3755.09.20	100
Pg 11	M20x1.5	24	12	8	3755.11.20	100
Pg 13	M25x1.5	30	13	9	3755.13.25	100
Pg 16	M25x1.5	30	13	10	3755.16.25	50
Pg 21	M32x1.5	37	14	11	3755.21.32	50
Pg 29	M40x1.5	45	14	11	3755.29.40	50
Pg 42	M50x1.5	55	17	11	3755.42.50	10
Pg 48	M63x1.5	68	17	11	3755.48.63	5



Aussengewinde Pg
Innengewinde metrisch
Hellgrau RAL 7035

Outer thread Pg
Inner thread metric
Light grey RAL 7035

G	I	 mm	H mm	L mm	Art.-No.	
Pg 9	M12x1.5	19	12	8	3455.09.12	100
Pg 11	M16x1.5	22	12	8	3455.11.17	100
Pg 13	M16x1.5	24	13	9	3455.13.17	100
Pg 13	M20x1.5	24	13	9	3455.13.20	100
Pg 16	M20x1.5	27	13	10	3455.16.20	50
Pg 21	M25x1.5	33	14	11	3455.21.25	50
Pg 29	M32x1.5	42	14	11	3455.29.32	50
Pg 36	M40x1.5	55	14	11	3455.36.40	25



1
2
3
4
5
6
7
8
9
10
11
12
13
14
15

Verschlusschraube Messing

Locking plug nickel-plated brass

Kurzes Anschlussgewinde metrisch | Short entry thread metric

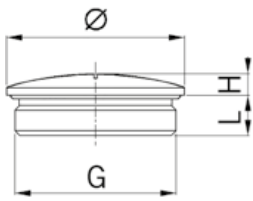

Material: Messing vernickelt
 O-Ring: NBR
 Schutzart: IP 68
 Einsatztemperatur: -40 °C / +100 °C

Material: Nickel-plated brass
 O-ring: NBR
 Protection class: IP 68
 Operation temperature: -40 °C / +100 °C



Runde Bauform
mit O-Ring

Round execution
with O-ring

G	Ø mm	H mm	L mm	i info	Art.-No.	
M6x1.0	9	3	5	1	8706.08	50
M8x1.25	10	3	5	1	8708.08	50
M10x1.5	12	3	5	1	8710.08	50
M12x1.5	14	3	5	-	8712.08	50
M16x1.5	19	3	5	-	8717.08	50
M20x1.5	24	3	6	-	8720.08	25
M25x1.5	28	4	7	-	8725.08	25
M32x1.5	35	4	8	-	8732.08	10
M40x1.5	45	6	8	-	8740.08	10
M50x1.5	55	6	9	-	8750.08	10
M63x1.5	70	6	10	-	8763.08	10
M75x1.5	80	6	11	-	8775.08	5

1 = Metrisches Regelgewinde

1 = Metric coarse-pitch thread

Langes Anschlussgewinde metrisch | Long entry thread metric



Runde Bauform
mit O-Ring

Round execution
with O-ring

G	Ø mm	H mm	L mm	i info	Art.-No.	
M6x1.0	9	3	8	1	8706.11.08	50
M8x1.25	10	3	10	1	8708.11.08	50
M10x1.5	12	3	10	1	8710.11.08	50
M12x1.5	14	3	10	-	8712.11.08	50
M16x1.5	19	3	10	-	8717.11.08	50
M20x1.5	24	3	10	-	8720.11.08	25
M25x1.5	28	4	11	-	8725.11.08	25
M32x1.5	35	4	13	-	8732.11.08	10
M40x1.5	45	6	13	-	8740.11.08	10
M50x1.5	55	6	14	-	8750.11.08	10
M63x1.5	70	6	15	-	8763.11.08	10
M75x1.5	80	6	15	-	8775.11.08	5

1 = Metrisches Regelgewinde

1 = Metric coarse-pitch thread

Verschlusschraube Messing Locking plug nickel-plated brass

Kurzes Anschlussgewinde metrisch | Short entry thread metric

Material: Messing vernickelt
Schutzart: IP 54
Gewinde: IP 68, wenn Anschluss-
gewinde abgedichtet
Einsatztemperatur: -40 °C / +200 °C

Material: Nickel-plated brass
Protection class: IP 54
Entry thread: IP 68, if the entry thread
is sealed
Operation temperature: -40 °C / +200 °C

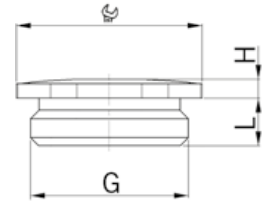

mit 6-kant
ohne O-Ring

with hexagon
without O-Ring

G		H	L	Art.-No.	
	mm	mm	mm		
M12x1.5	14	2.5	5	8745.12	100
M16x1.5	18	2.5	5	8745.17	100
M20x1.5	22	2.5	6	8745.20	100
M25x1.5	27	3.0	7	8745.25	50
M32x1.5	34	3.5	8	8745.32	25
M40x1.5	42	4.0	8	8745.40	25
M50x1.5	52	4.0	9	8745.50	10
M63x1.5	65	4.0	10	8745.63	10



Kurzes Anschlussgewinde Pg | Short entry thread Pg

Material: Messing vernickelt
O-Ring: NBR
Schutzart: IP 68
Einsatztemperatur: -40 °C / +100 °C

Material: Nickel-plated brass
O-ring: NBR
Protection class: IP 68
Operation temperature: -40 °C / +100 °C

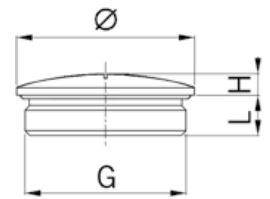

Runde Bauform
mit O-Ring

Round execution
with O-ring

G	Ø	H	L	Art.-No.	
	mm	mm	mm		
Pg 7	14	3	5	8707.08	100
Pg 9	17	3	6	8709.08	100
Pg 11	20	3	6	8711.08	100
Pg 13	22	3	6.5	8713.08	50
Pg 16	24	3	6.5	8716.08	50
Pg 21	30	4	7	8721.08	10
Pg 29	39	4	8	8729.08	10
Pg 36	50	6	9	8736.08	10
Pg 42	60	6	10	8742.08	10
Pg 48	65	6	10	8748.48.08	10
G 2"	65	6	10	8748.08	10



1
2
3
4
5
6
7
8
9
10
11
12
13
14
15

Verschlusschraube Messing

Locking plug nickel-plated brass

Langes Anschlussgewinde Pg | Long entry thread Pg

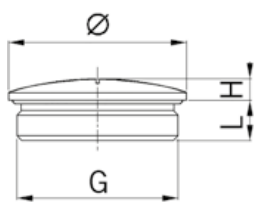

Material: Messing vernickelt
 O-Ring: NBR
 Schutzart: IP 68
 Einsatztemperatur: -40 °C / +100 °C

Material: Nickel-plated brass
 O-ring: NBR
 Protection class: IP 68
 Operation temperature: -40 °C / +100 °C



Runde Bauform
mit O-Ring

Round execution
with O-ring

G	Ø mm	H mm	L mm
Pg 7	14	3	10
Pg 9	17	3	10
Pg 11	20	3	10
Pg 13	22	3	10
Pg 16	24	3	10
Pg 21	30	4	12
Pg 29	39	4	12
Pg 36	50	6	15

Art.-No.



				8707.11.08	100
				8709.11.08	100
				8711.11.08	100
				8713.11.08	50
				8716.11.08	50
				8721.11.08	10
				8729.11.08	10
				8736.11.08	10

Runde Bauform | Round execution

Material: Rostfreier CrNi-Stahl A2
(DIN EN 1.4305 / AISI 303)

O-Ring: NBR

Schutzart: IP 68

Einsatztemperatur: -40 °C / +100 °C

Material: CrNi stainless steel A2
(DIN EN 1.4305 / AISI 303)

O-ring: NBR

Protection class: IP 68

Operation temperature: -40 °C / +100 °C

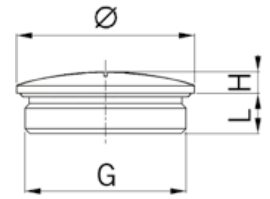

Kurzes Anschlussgewinde metrisch
mit O-Ring

Short entry thread metric
with O-ring

G	Ø	H	L	i	Art.-No.	
	mm	mm	mm	info		
M10x1.5	12	3	5	1	8710.96.08.70	50
M12x1.5	14	3	5	-	8712.96.08.70	50
M16x1.5	19	3	5	-	8717.96.08.70	50
M20x1.5	24	3	6	-	8720.96.08.70	25
M25x1.5	28	4	7	-	8725.96.08.70	25
M32x1.5	35	4	8	-	8732.96.08.70	10
M40x1.5	45	6	8	-	8740.96.08.70	10
M50x1.5	55	6	9	-	8750.96.08.70	10
M63x1.5	70	6	10	-	8763.96.08.70	10
M75x1.5	80	6	11	-	8775.96.08.70	5

1 = Metrisches Regelgewinde

1 = Metric coarse-pitch thread

Auf Anfrage lieferbar:

Available on request:

Anschlussgewinde Pg

Entry thread Pg



Langes Anschlussgewinde metrisch
mit O-Ring

Long entry thread metric
with O-ring

G	Ø	H	L	i	Art.-No.	
	mm	mm	mm	info		
M10x1.5	12	3	10	1	8710.96.11.08.70	50
M12x1.5	14	3	10	-	8712.96.11.08.70	50
M16x1.5	19	3	10	-	8717.96.11.08.70	50
M20x1.5	24	3	10	-	8720.96.11.08.70	25
M25x1.5	28	4	11	-	8725.96.11.08.70	25
M32x1.5	35	4	13	-	8732.96.11.08.70	10
M40x1.5	45	6	13	-	8740.96.11.08.70	10
M50x1.5	55	6	14	-	8750.96.11.08.70	10
M63x1.5	70	6	15	-	8763.96.11.08.70	10
M75x1.5	80	6	15	-	8775.96.11.08.70	5

1 = Metrisches Regelgewinde

1 = Metric coarse-pitch thread

Auf Anfrage lieferbar:

Available on request:

Anschlussgewinde Pg

Entry thread Pg



1
2
3
4
5
6
7
8
9
10
11
12
13
14
15

Verschlusschrauben rostfreier Stahl A2 für hohe Temperaturen

Locking plugs stainless steel A2 for high temperature applications

Runde Bauform | Round execution

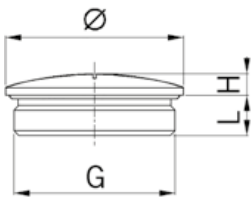

Material: Rostfreier CrNi-Stahl A2 (DIN EN 1.4305 / AISI 303)
 O-Ring: FPM
 Schutzart: IP 68
 Einsatztemperatur: -40 °C / +200 °C

Material: CrNi stainless steel A2 (DIN EN 1.4305 / AISI 303)
 O-ring: FPM
 Protection class: IP 68
 Operation temperature: -40 °C / +200 °C



Kurzes Anschlussgewinde metrisch mit O-Ring

Short entry thread metric with O-ring

G	Ø mm	H mm	L mm	i info	Art.-No.	
M10x1.5	12	3	5	1	8710.96.08	50
M12x1.5	14	3	5	-	8712.96.08	50
M16x1.5	19	3	5	-	8717.96.08	50
M20x1.5	24	3	6	-	8720.96.08	25
M25x1.5	28	4	7	-	8725.96.08	25
M32x1.5	35	4	8	-	8732.96.08	10
M40x1.5	45	6	8	-	8740.96.08	10
M50x1.5	55	6	9	-	8750.96.08	10
M63x1.5	70	6	10	-	8763.96.08	10
M75x1.5	80	6	11	-	8775.96.08	5

1 = Metrisches Regelgewinde

1 = Metric coarse-pitch thread

Auf Anfrage lieferbar:

Available on request:

Anschlussgewinde Pg

Entry thread Pg



Langes Anschlussgewinde metrisch mit O-Ring

Long entry thread metric with O-ring

G	Ø mm	H mm	L mm	i info	Art.-No.	
M10x1.5	12	3	10	1	8710.96.11.08	50
M12x1.5	14	3	10	-	8712.96.11.08	50
M16x1.5	19	3	10	-	8717.96.11.08	50
M20x1.5	24	3	10	-	8720.96.11.08	25
M25x1.5	28	4	11	-	8725.96.11.08	25
M32x1.5	35	4	13	-	8732.96.11.08	10
M40x1.5	45	6	13	-	8740.96.11.08	10
M50x1.5	55	6	14	-	8750.96.11.08	10
M63x1.5	70	6	15	-	8763.96.11.08	10
M75x1.5	80	6	15	-	8775.96.11.08	5

1 = Metrisches Regelgewinde

1 = Metric coarse-pitch thread

Auf Anfrage lieferbar:

Available on request:

Anschlussgewinde Pg

Entry thread Pg

Anschlussgewinde metrisch | Entry thread metric

Material: Polyamid PA 6
 Schutzart: IP 54
 Gewinde: IP 68, wenn Anschluss-
 gewinde abgedichtet
 Einsatztemperatur: -30 °C / +100 °C

Material: Polyamide PA 6
 Protection class: IP 54
 Entry thread: IP 68, if the entry thread
 is sealed
 Operation temperature: -30 °C / +100 °C

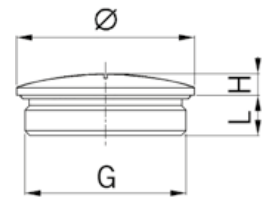

Hellgrau RAL 7035
 ohne O-Ring

Light grey RAL 7035
 without O-Ring

G	Ø mm	H mm	L mm	Art.-No.	
M12x1.5	15	4.5	6	8855.12	100
M16x1.5	20	4.5	6	8855.17	100
M20x1.5	24	4.5	6	8855.20	100
M25x1.5	30	5.0	8	8855.25	100
M32x1.5	37	5.5	8	8855.32	50
M40x1.5	46	6.0	8	8855.40	50
M50x1.5	56	6.0	10	8855.50	10
M63x1.5	70	6.0	12	8855.63	10



Schwarz RAL 9005
 ohne O-Ring

Black RAL 9005
 without O-Ring

G	Ø mm	H mm	L mm	Art.-No.	
M12x1.5	15	4.5	6	8845.12	100
M16x1.5	20	4.5	6	8845.17	100
M20x1.5	24	4.5	6	8845.20	100
M25x1.5	30	5.0	8	8845.25	100
M32x1.5	37	5.5	8	8845.32	50
M40x1.5	46	6.0	8	8845.40	50
M50x1.5	56	6.0	10	8845.50	10
M63x1.5	70	6.0	12	8845.63	10



Anschlussgewinde Pg | Entry thread Pg

Material: Polystyrol schlagfest
 Schutzart: IP 54
 Gewinde: IP 68, wenn Anschluss-
 gewinde abgedichtet
 Einsatztemperatur: -20 °C / +80 °C

Material: Shock-resistant polystyrene
 Protection class: IP 54
 Entry thread: IP 68, if the entry thread
 is sealed
 Operation temperature: -20 °C / +80 °C

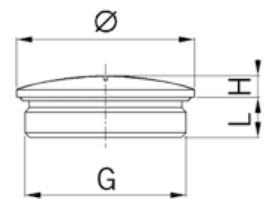

Hellgrau RAL 7035
 ohne O-Ring

Light grey RAL 7035
 without O-Ring

G	Ø mm	H mm	L mm	Art.-No.	
Pg 7	15	2.0	6.0	8807	100
Pg 9	19	3.0	6.5	8809	100
Pg 11	22	3.5	6.5	8811	100
Pg 13	25	3.5	6.5	8813	100
Pg 16	27	3.5	6.5	8816	100
Pg 21	33	4.0	8.0	8821	100
Pg 29	44	4.0	8.0	8829	50
Pg 36	55	4.0	10.0	8836	25
Pg 42	62	6.0	10.0	8842	10



1
2
3
4
5
6
7
8
9
10
11
12
13
14
15

Dichteinsätze Vollgummi

Solid rubber sealing inserts

passend zu Kabelverschraubungen Progress® | suitable for cable glands Progress®

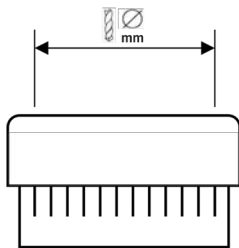

Material: NBR
Einsatztemperatur: -40 °C / +100 °C

Material: NBR
Operation temperature: -40 °C / +100 °C



Kurzer Dichteinsatz ohne Bohrung

Short sealing insert without drilled hole

G	 mm	Art.-No.	
M6	3.5	1000.06.30.03	1
M8	5.0	1000.08.30.03	1
M10	6.0	1000.10.30.03	1
Pg 11	12.0	1000.11.30.03	1
M12 / Pg 7	8.0	1000.12.30.03	1
M16 / Pg 9	10.5	1000.17.30.03	1
M20 / Pg 13 / Pg 16	15.0	1000.20.30.03	1
M25 / Pg 21	20.5	1000.25.30.03	1
Pg 29	27.5	1000.29.30.03	1
M32	25.5	1000.32.30.03	1
Pg 36	35.0	1000.36.30.03	1
M40	33.0	1000.40.30.03	1
Pg 48	49.0	1000.48.30.03	1
M50 / Pg 42	42.0	1000.50.30.03	1
M63	52.0	1000.63.30.03	1
M75	63.0	1000.75.30.03	1
M85	70.0	1000.085.30.03	1
M95	80.0	1000.095.30.03	1
M100	85.0	1000.100.30.03	1
M105	90.0	1000.105.30.03	1
M115	95.0	1000.115.30.03	1

Dichteinsätze ohne Bohrung lassen sich gut bearbeiten, wenn sie vorher auf mindestens -25°C gefroren wurden.

When frozen to at least -25°C, the solid sealing inserts are easy to drill.

Dichteinsätze Vollgummi für hohe Temperaturen

Solid rubber sealing inserts for high- temperatures applications

passend zu Kabelverschraubungen Progress® | suitable for cable glands Progress®

Material: FPM
Einsatztemperatur: -40 °C / +200 °C

Material: FPM
Operation temperature: -40 °C / +200 °C

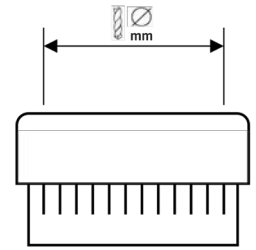

Kurzer Dichteinsatz ohne Bohrung

Short sealing insert without drilled hole

G	 mm	Art.-No.	
M6	3.5	1000.06.98.30.03	1
M8	5.0	1000.08.98.30.03	1
M10	6.0	1000.10.98.30.03	1
Pg 11	12.0	1000.11.98.30.03	1
M12 / Pg 7	8.0	1000.12.98.30.03	1
M16 / Pg 9	10.5	1000.17.98.30.03	1
M20 / Pg 16	15.0	1000.20.98.30.03	1
M25 / Pg 21	20.5	1000.25.98.30.03	1
Pg 29	27.5	1000.29.98.30.03	1
M32	25.5	1000.32.98.30.03	1
Pg 36	35.0	1000.36.98.30.03	1
M40 / Pg 29	33.0	1000.40.98.30.03	1
Pg 48	49.0	1000.48.98.30.03	1
M50 / Pg 42	42.0	1000.50.98.30.03	1
M63	52.0	1000.63.98.30.03	1

Dichteinsätze ohne Bohrung lassen sich gut bearbeiten, wenn sie vorher auf mindestens -25°C gefroren wurden.

When frozen to at least -25°C, the solid sealing inserts are easy to drill.



1
2
3
4
5
6
7
8
9
10
11
12
13
14
15

passend zu Kabelverschraubungen Progress® | suitable for cable glands Progress®

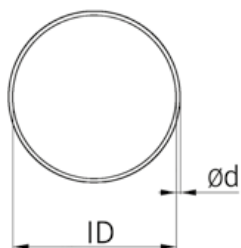

Material: NBR
Einsatztemperatur: -40 °C / +100 °C

Material: NBR
Operation temperature: -40 °C / +100 °C



zu Anschlussgewinde metrisch oder Pg

suitable for entry thread metric or Pg

G	Øl mm	Ød mm	Art.-No.	
M 6	5.0	1.0	1005.00.08	1
M 8	6.0	1.5	1006.00.08	1
M10	8.1	1.6	1006.06.08	1
M12 / Pg 7	10.0	1.5	1007.00.08	1
M16 / Pg 9	13.1	1.6	1000.09.00.08	1
M20	17.0	2.0	2111.00.08	1
M25	22.0	2.0	1013.00.22.08	1
M32	30.0	2.0	1021.00.30.08	1
M40	36.0	2.0	1000.40.00.08	1
M50	46.0	2.0	1000.50.00.08	1
M63	60.0	2.0	1000.63.00.08	1
M75	72.0	2.0	1000.75.00.08	1
Pg 11	15.0	2.0	1011.00.08	1
Pg 13 / Pg 16	19.0	2.0	1016.00.08	1
Pg 21	25.0	2.0	1016.00.25.08	1
Pg 29	33.3	2.4	1029.00.08	1
Pg 36	42.5	2.6	1036.00.08	1
Pg 42	48.0	3.0	1000.42.00.08	1
Pg 48	55.0	2.0	1000.48.00.08	1

passend zu Kabelverschraubungen Progress® | suitable for cable glands Progress®

Material: FPM
Einsatztemperatur: -40 °C / +200 °C

Material: FPM
Operation temperature: -40 °C / +200 °C

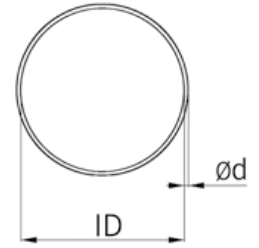

zu Anschlussgewinde metrisch oder Pg

suitable for entry thread metric or Pg

G	Øl mm	Ød mm	Art.-No.	
M 6	5.0	1.0	1105.98.08	1
M 8	6.0	1.8	1106.98.08	1
M10	8.1	1.6	1106.06.98.08	1
M12 / Pg 7	10.0	1.5	1107.98.08	1
M16 / Pg 9	13.1	1.6	1100.09.98.08	1
M20	17.0	2.0	2111.98.08	1
M25	22.0	2.0	1113.98.22.08	1
M32	30.0	2.0	1121.98.30.08	1
M40	36.0	2.0	1100.40.98.08	1
M50	46.0	2.0	1100.50.98.08	1
M63	60.0	2.0	1100.63.98.08	1
M75	72.0	2.0	1100.75.98.08	1
Pg 11	15.0	2.0	1111.98.08	1
Pg 13 / Pg 16	18.0	2.0	1116.98.08	1
Pg 21	25.0	2.0	1116.98.25.08	1
Pg 29	31.4	2.2	1129.98.08	1
Pg 36	42.5	2.6	1136.98.08	1



1
2
3
4
5
6
7
8
9
10
11
12
13
14
15

Dichtungsscheiben

Sealing washers

passend zu Kabelverschraubungen Progress® | suitable for cable glands Progress®

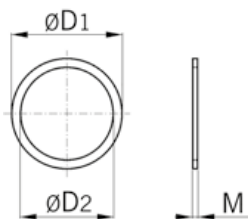

Material: KlingerSIL C-4300
 Farbe: grün
 Einsatztemperatur: -60 °C / +300 °C

Material: KlingerSIL C-4300
 Colour: green
 Operation temperature: -60 °C / +300 °C



zu Anschlussgewinde metrisch

suitable for metric entry thread

G	ØD1 mm	ØD2 mm	M mm	Art.-No.	
M6	10.0	6.0	1.5	1006.00.16	50
M8	12.0	8.0	1.5	1008.00.16	50
M10	14.0	10.0	1.5	1010.00.16	50
M12	16.0	12.0	1.5	1012.00.16	50
M16	21.0	16.0	1.5	1017.00.16	50
M20 / Pg 13	25.0	20.5	1.5	1013.00.16	50
M25	31.0	25.0	2.0	1025.00.16	50
M32	39.0	32.0	2.0	1032.00.16	50
M40	48.0	40.0	2.0	1040.00.16	50
M50	59.0	50.0	2.0	1050.00.16	50
M63	73.0	63.0	2.0	1063.00.16	50



zu Anschlussgewinde Pg

suitable for entry thread Pg

G	ØD1 mm	ØD2 mm	M mm	Art.-No.	
Pg 7	16.5	12.5	1.5	1007.00.16	50
Pg 9	19.0	15.2	1.5	1009.00.16	50
Pg 11	22.5	18.5	1.5	1011.00.16	50
M20 / Pg 13	25.0	20.5	1.5	1013.00.16	50
Pg 16	27.0	22.5	1.5	1016.00.16	50
Pg 21	33.5	28.5	2.0	1021.00.16	50
Pg 29	43.5	37.0	2.0	1029.00.16	50
Pg 36	55.0	47.0	2.0	1036.00.16	50
Pg 42	63.0	54.0	2.0	1042.00.16	50
Pg 48	69.0	59.3	2.0	1048.00.16	50

passend zu Kabelverschraubungen Syntec® | suitable for cable glands Syntec®

Material: Perbunan
Einsatztemperatur: -20 °C / +120 °C

Material: Perbunan
Operation temperature: -20 °C / +120 °C

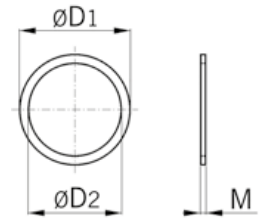

zu Anschlussgewinde metrisch

suitable for metric entry thread

G	ØD1 mm	ØD2 mm	M mm	Art.-No.	
M12	20	12	1.5	1012.45.16	50
M16	23	16	2.0	1017.45.16	50
M20	29	20	2.0	1020.45.16	50
M25	37	25	2.0	1025.45.16	50
M32	44	32	2.0	1032.45.16	25
M40	52	40	2.0	1040.45.16	25
M50	64	50	2.5	1050.45.16	25
M63	66	60.5	3.0	1063.45.16	10



zu Anschlussgewinde Pg

suitable for entry thread Pg

G	ØD1 mm	ØD2 mm	M mm	Art.-No.	
Pg 7	16.0	11.5	2.0	1007.45.16	50
Pg 9	19.0	14.0	2.0	1009.45.16	50
Pg 11	22.5	18.5	2.0	1011.45.16	50
Pg 13	25.0	19.0	2.0	1013.45.16	50
Pg 16	27.0	21.0	2.0	1016.45.16	50
Pg 21	34.0	27.0	2.5	1021.45.16	25
Pg 29	43.0	35.0	2.5	1029.45.16	25
Pg 36	54.0	45.0	2.5	1036.45.16	25



1
2
3
4
5
6
7
8
9
10
11
12
13
14
15

Einschnittringe NBR passend zu Stopfbuchsen B 107- B 263

Sealing rings NBR suitable for cable gland B 107 - B 263

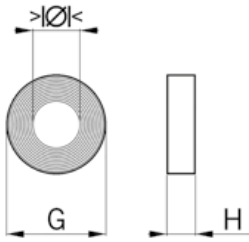

Material: NBR
Einsatzbereich: Passend zu Stopfbuchsen B107 - B263
Einsatztemperatur: -20 °C / +100 °C

Material: NBR
Application: Suitable for cable glands series B107 - B263
Operation temperature: -20 °C / +100 °C



G	>Ø< min mm	>Ø< max mm	H mm	Art.-No.	
M12 / Pg 7	6.0	8.0	5.0	B 107.00.03	50
M16 / Pg 9	4.0	11.0	5.5	B 109.00.03	50
Pg 11	6.5	12.0	6.0	B 111.00.03	50
Pg 13	6.5	13.5	6.0	B 113.00.03	50
M20 / Pg 16	6.5	16.0	7.0	B 116.00.03	50
M25 / Pg 21	9.0	20.0	8.0	B 121.00.03	50
M32 / Pg 29	17.0	28.0	9.5	B 129.00.03	50
M40 / Pg 36	23.0	34.0	12.0	B 136.00.03	50
M50 / Pg 42	29.0	40.0	14.0	B 142.00.03	10
M63 / Pg 48	35.0	46.0	14.0	B 148.00.03	10

Blindscheiben passend zu Kabelverschraubungen | Blind discs suitable for cable glands

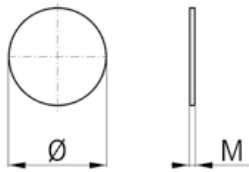

Material: Polyamid
Einsatzbereich: Staubverschluss zu Kabelverschraubungen
Einsatztemperatur: -20 °C / +100 °C

Material: Polyamide
Application: Dust stopper for cable glands
Operation temperature: -20 °C / +100 °C



G	Ø mm	M mm	Art.-No.	
M10 / M12 / Pg 7	10.5	0.3	1012.00.19	50
M16 / Pg 9	13.5	0.3	1017.00.19	50
M20 / Pg 11	16.5	0.3	1011.00.19	50
Pg 13 / Pg 16	20.5	0.3	1020.00.19	50
M25 / Pg 21	26.5	0.3	1025.00.19	50
Pg 29	35.0	0.3	1029.00.19	50
M32	30.0	0.3	1032.00.19	50
Pg 36	45.0	0.3	1036.00.19	50
M40	38.0	0.3	1040.00.19	50
M50 / Pg 42	52.0	0.3	1050.00.19	50
M63 / Pg 48	57.0	0.3	1063.00.19	50

aus Kunststoff zu Mehrfach-Kabelverschraubungen | synthetic, for multi-duct cable glands

Material: Polyamid PA 6
Einsatzbereich: Zum Verschliessen nicht belegter Bohrungen in Mehrfach-Kabelverschraubungen
Einsatztemperatur: -30 °C / +100 °C

Material: Polyamide PA 6
Application: Usable as inserts to close unused holes in sealings of multi-duct cable glands
Operation temperature: -30 °C / +100 °C

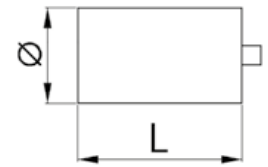

Verschlussbolzen zu Kabelverschraubungen

Locking pins for cable glands

$\frac{>\text{Ø}<}{\text{mm}}$	L mm	Art.-No.	
2	12	1310.020.07	50
3	14	1310.030.07	50
4	14	1310.040.07	50
5	14	1310.050.07	50
6	14	1310.060.07	50
7	14	1310.070.07	50
8	14	1310.080.07	50
9	14	1310.090.07	50
10	14	1310.100.07	50
11	14	1310.110.07	50
12	14	1310.120.07	50



für Multi-Kabelverschraubungen | for multi cable glands

Material: Messing vernickelt
Einsatzbereich: Zum Verschliessen nicht belegter Bohrungen in Mehrfach-Kabelverschraubungen
Einsatztemperatur: -60 °C / +100 °C

Material: Nickel-plated brass
Application: Usable as inserts to close unused holes in sealings of multi-duct cable glands
Operation temperature: -60 °C / +100 °C

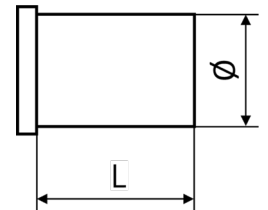

Verschlussbolzen zu Kabelverschraubungen

Locking pins for cable glands

$\frac{>\text{Ø}<}{\text{mm}}$	L mm	Art.-No.	
1.5	6	EX1310.015.07	25
3	7	EX1310.030.07	25
4	7	EX1310.040.07	25
5	7	EX1310.050.07	25
6	7	EX1310.060.07	25
7	7	EX1310.070.07	25
9	9	EX1310.090.07	25
10	9	EX1310.100.07	25
12	11	EX1310.120.07	25
15	11	EX1310.150.07	25
18	12	EX1310.180.07	25



Einsetzbar auch für Ex Multi-Kabelverschraubungen

Can also be used for Ex multi cable glands

1
2
3
4
5
6
7
8
9
10
11
12
13
14
15

Spezialwerkzeug für Kabelverschraubungen

Special tool for cable glands

Für Kabelverschraubungen | For cable glands

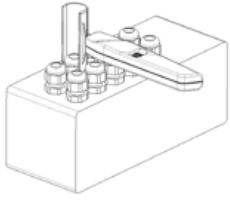

Einsatzbereich:

Montagewerkzeug für Kabelverschraubungen bei engsten Platzverhältnissen

Application:

Assembly tool for cable glands in restricted spaces

Eigenschaften:

Nur 2 Werkzeuge für Schlüsselweiten von 11 bis 36 mm notwendig, Zeitersparnis durch Ratschenfunktion



Properties:

Only 2 tools necessary for wrench sizes from 11 to 36 mm, time-saving due to the ratchet function



verstellbare Schlüsselweiten
bei geringem Platzbedarf

adjustable wrench sizes
for restricted spaces

 1 mm	 2 mm	L mm	B mm
11	24	190	60
24	36	204	60

Art.-No.







4800.24

1

4800.36

1



AGROflex PET Geflechschläuche Polyester AGROflex PET braided sleeveings polyester		287 - 288
AGROflex Box PET Geflechschläuche in Spenderboxen AGROflex Box PET braided sleeveings in dispenser boxes		288
AGROflex PA Geflechschläuche Polyamid AGROflex PA braided cable sleeveings polyamide		289
AGROsnap selbstschliessender Gewebeslauch AGROsnap self-closing braided sleeve		290 - 291

1

2

3

4

5

6

7

8

9

10

11

12

13

14

15

AGROflex Geflechschläuche in Polyester und Polyamid

AGROflex braided sleeves made of polyester and polyamide



In Zusammenarbeit mit namhaften Kunden haben wir die Produkteigenschaften erarbeitet, welche für den Anwender besonders wichtig sind und versucht, diese Kriterien zusammen mit Produktionstechnikern in verbesserte Produkte umzusetzen.

Die bemerkenswerteste Änderung ist der spitzere Flechtwinkel, in welchem die Einzelfäden miteinander verwoben sind. Diese neue Flechtweise kombiniert mit einem etwas dünneren Monofil bei der Ausführung in Polyester führt zu einem extrem flexiblen Schlauch und zu einer hervorragenden Aufstauchbarkeit. Die Geflechte lassen sich auf das Doppelte ihrer Nennweite aufstauchen.

Der spitzere Flechtwinkel erlaubt ein geschmeidigeres Einführen von Leitungen und Kabeln auch über grössere Längen. Die Einzelfilamente laufen sozusagen parallel zu den Kabeln und stellen sich ihnen nicht als Hindernis oder „Einfädelstelle“ in den Weg.

Wichtigste Eigenschaften

- Hochflexibel
- Aufstauchverhältnis 1 : 2
- Gute Laugen- und Säurenbeständigkeit
- Geprüft nach EN 45545-2 Hazard Level 3

In cooperation with our well-known customers, we have defined the product properties which are especially important for the user and have worked with our production engineers to translate these criteria into improved products.

The most notable change is the more pointed braid angle with which the individual strands are woven together. This new way of braiding, combined with a slightly thinner monofilament in the polyester version, results in an extremely flexible sleeving and in outstanding stretching qualities. The braiding can stretch to twice its nominal width.

The more pointed braid angle permits smoother insertion of power cords and cables, even across long distances. The individual strands run more parallel to the cable and do not obstruct or “catch” the cable.

Key properties

- Extremely flexible
- Shortening/expansion ratio 1 : 2
- High resistance to acids and alkaline substances
- Tested according to EN 45545-2 Hazard Level 3

Material: Polyester PET
 Monofil: Ø 0.22mm
 Eigenschaften: Hochflexibel, selbstanpassend, abriebfest, frei von Cadmium, Formaldehyd, Halogen und Graphit, selbstverlöschend nach DIN 75200 (FMVSS 302), gute Beständigkeit gegen Kraftstoffe, Mineralöle und Chemikalien

Aufweitung: Aufstauchverhältnis 1 : 2
 Zulassung: EN 45545-2 (HL3)
 Einsatztemperatur: -50 °C / +150 °C

Material: Polyester PET
 Monofil: Ø 0.22mm
 Properties: Highly flexible, self-adapting, resistant to abrasion, free of cadmium, formaldehyde, halogen and graphite, self-extinguishing acc. to DIN 75200 (FMVSS 302), good resistance to fuel, mineral oil and chemicals

Expansion: Expansion ratio 1 : 2
 Approval: EN 45545-2 (HL3)
 Operation temperature: -50 °C / +150 °C

Polyester PET Schwarz matt				Polyester PET Black matt	
NW	Ø min mm	Ø max mm	OFB %	Art.-No.	
3	2	6	86	6875.40.03	200
5	4	10	89	6875.40.05	200
8	7	15	81	6875.40.08	150
10	8	20	79	6875.40.10	150
15	13	25	81	6875.40.15	100
20	16	28	77	6875.40.20	100
24	24	38	82	6875.40.24	100
36	34	60	78	6875.40.36	100
50	45	80	82	6875.40.50	100

OFB = Oberflächendeckung
 Auf Anfrage lieferbar:
 Verpackungseinheiten auf Grossrollen

OFB = Percentage of the surface covered by fabric
 Available on request:
 Packaging units on large rolls



AGROflex PET



Polyester PET Grau matt				Polyester PET Grey matt	
NW	Ø min mm	Ø max mm	OFB %	Art.-No.	
3	2	6	86	6875.70.03	200
5	4	10	89	6875.70.05	200
8	7	15	81	6875.70.08	150
10	8	20	79	6875.70.10	100
15	13	25	81	6875.70.15	100
20	16	28	77	6875.70.20	100
24	24	38	82	6875.70.24	100
36	34	60	78	6875.70.36	100
50	45	80	82	6875.70.50	100

OFB = Oberflächendeckung
 Auf Anfrage lieferbar:
 Verpackungseinheiten auf Grossrollen

OFB = Percentage of the surface covered by fabric
 Available on request:
 Packaging units on large rolls



AGROflex PET



1
2
3
4
5
6
7
8
9
10
11
12
13
14
15

AGROflex Box PET Geflechtschlauch in Spenderbox AGROflex Box PET braided sleeving in dispenser box

Geflechtschlauch für Elektrofahrzeuge | Braided sleeving for electric vehicles

Material:	Polyester PET	Material:	Polyester PET
Monofil:	Ø 0.25mm	Monofil:	Ø 0.25mm
Eigenschaften:	Hochflexibel, selbstanpassend, abriebfest, frei von Cadmium, Formaldehyd, Halogen und Graphit, selbstverlöschend nach DIN 75200 (FMVSS 302), gute Beständigkeit gegen Kraftstoffe, Mineralöle und Chemikalien	Properties:	Highly flexible, self-adapting, resistant to abrasion, free of cadmium, formaldehyde, halogen and graphite, self-extinguishing acc. to DIN 75200 (FMVSS 302), good resistance to fuel, mineral oil and chemicals
Aufweitung:	Aufstauchverhältnis 1 : 2	Expansion:	Expansion ratio 1 : 2
Einsatzbereich:	Farbe Orange für Elektrofahrzeuge	Application:	Colour orange for electric vehicles
Einsatztemperatur:	-55 °C / +150 °C	Operation temperature:	-55 °C / +150 °C



Polyester PET Orange				Polyester PET Orange	
NW	Ø min mm	Ø max mm	OFB %	Art.-No.	
5	4	10	89	6875.80.05	200
8	6	11	85	6875.80.08	100
10	8	14	84	6875.80.10	100
12	10	16	88	6875.80.12	100
16	14	24	86	6875.80.16	100
20	18	25	88	6875.80.20	100
25	18	33	87	6875.80.25	100
35	30	52	85	6875.80.35	100
45	38	60	85	6875.80.45	100

Farbe Orange für Elektrofahrzeuge
OFB = Oberflächendeckung

Colour orange for electric vehicles
OFB = Percentage of the surface covered by fabric

Spenderbox für Service und Unterhalt | Dispenser box for service and maintenance

Material:	Polyester PET	Material:	Polyester PET
Monofil:	Ø 0.22mm	Monofil:	Ø 0.22mm
Eigenschaften:	Hochflexibel, selbstanpassend, abriebfest, frei von Cadmium, Formaldehyd, Halogen und Graphit, selbstverlöschend nach DIN 75200 (FMVSS 302), gute Beständigkeit gegen Kraftstoffe, Mineralöle und Chemikalien	Properties:	Highly flexible, self-adapting, resistant to abrasion, free of cadmium, formaldehyde, halogen and graphite, self-extinguishing acc. to DIN 75200 (FMVSS 302), good resistance to fuel, mineral oil and chemicals
Aufweitung:	Aufstauchverhältnis 1 : 2	Expansion:	Expansion ratio 1 : 2
Zulassung:	EN 45545-2 (HL3)	Approval:	EN 45545-2 (HL3)
Einsatztemperatur:	-50 °C / +150 °C	Operation temperature:	-50 °C / +150 °C



Schwarz				Black	
NW	Ø min mm	Ø max mm	i info	Art.-No.	
5	3	10	12 m	6875.40.05.10	1
10	8	20	12 m	6875.40.10.10	1
18	18	27	6 m	6875.40.18.06	1
30	23	50	6 m	6875.40.30.06	1

AGROflex PA Geflechschläuche Polyamid

AGROflex PA braided cable sleeves polyamide

Material: Polyamid PA 6
 Monofil: Ø 0.25mm
 Eigenschaften: Hochflexibel, selbstanpassend, abriebfest, frei von Cadmium, Formaldehyd, Halogen und Graphit, selbstverlöschend nach DIN 75200 (FMVSS 302), gute Beständigkeit gegen Kraftstoffe, Mineralöle und Chemikalien
 Aufweitung: Aufstauchverhältnis 1 : 2
 Einsatztemperatur: -55 °C / +125 °C

Material: Polyamide PA 6
 Monofil: Ø 0.25mm
 Properties: Highly flexible, self-adapting, resistant to abrasion, free of cadmium, formaldehyde, halogen and graphite, self-extinguishing acc. to DIN 75200 (FMVSS 302), good resistance to fuel, mineral oil and chemicals
 Expansion: Expansion ratio 1 : 2
 Operation temperature: -55 °C / +125 °C

Polyamid PA 6 Schwarz				Polyamide PA 6 Black	
NW	Ø min mm	Ø max mm	OFB %	Art.-No.	
3	2.5	6.0	85	6850.40.03	100
4	3.0	8.5	91	6850.40.04	100
5	4.0	10.0	95	6850.40.05	100
6	4.0	9.0	85	6850.40.06	100
10	6.0	15.0	90	6850.40.10	100
12	9.0	17.0	94	6850.40.12	100
16	14.0	26.0	87	6850.40.16	100
22	18.0	30.0	84	6850.40.22	100
24	20.0	35.0	82	6850.40.24	100
30	26.0	40.0	88	6850.40.30	100
35	28.0	40.0	88	6850.40.35	100
45	38.0	58.0	84	6850.40.45	100
50	35.0	80.0	88	6850.40.50	100
70	55.0	80.0	91	6850.40.70	100

OFB = Oberflächendeckung
 Grau auf Anfrage

OFB = Percentage of the surface covered by fabric
 Colour grey on request



1
2
3
4
5
6
7
8
9
10
11
12
13
14
15

AGROsnap selbstschliessender Gewebeslauch

AGROsnap self-closing braided sleeve

für nachträgliche Installation | for additional installation

Material: Monofil Polyester PET mit Multifil-Fasern
 Monofil: Ø 0.25mm
 Einsatzbereich: Problemloses Einziehen von vorkonfektionierten Kabeln, für nachträgliche Installation
 Eigenschaften: Hochflexibel, selbstanpassend, abriebfest, frei von Cadmium, Formaldehyd, Halogen und Graphit, selbstverlöschend nach DIN 75200 (FMVSS 302), gute Beständigkeit gegen Kraftstoffe, Mineralöle und Chemikalien
 Zertifikat: EN 45545-2 / NFPA 130
 Ausführung: gebündelter Wickelstrang
 Einsatztemperatur: -55 °C / +150 °C

Material: Monofil polyester PET with multifilament fibres
 Monofil: Ø 0.25mm
 Application: Sinking of pre-connectorised cables without problems, for additional installation
 Properties: Highly flexible, self-adapting, resistant to abrasion, free of cadmium, formaldehyde, halogen and graphite, self-extinguishing acc. to DIN 75200 (FMVSS 302), good resistance to fuel, mineral oil and chemicals
 Certificate: EN 45545-2 / NFPA 130
 Execution: bundled winding strand
 Operation temperature: -55 °C / +150 °C



Schwarz			Black	
NW	Ø min mm	Ø max mm	Art.-No.	
5	3	5	6879.40.05	50
8	5	8	6879.40.08	50
10	8	10	6879.40.10	50
13	10	13	6879.40.13	50
16	13	16	6879.40.16	50
19	16	19	6879.40.19	25
25	22	25	6879.40.25	25
29	26	29	6879.40.29	25
32	29	32	6879.40.32	25
38	35	44	6879.40.38	25
50	44	50	6879.40.50	25

Nominaler Innendurchmesser mit einer Überlappung von 25% / 90°

Nominal inner diameter with 25% / 90° overlap





AGROsnap selbstschliessender Gewebeslauch

AGROsnap self-closing braided sleeve

für nachträgliche Installation | for additional installation

Material:	Monofil Polyester PET mit Multifil-Fasern	Material:	Monofil polyester PET with multifilament fibres
Monofil:	Ø 0.25mm	Monofil:	Ø 0.25mm
Einsatzbereich:	Problemloses Einziehen von vorkonfektionierten Kabeln, für nachträgliche Installation	Application:	Sinking of pre-connectorised cables without problems, for additional installation
Eigenschaften:	Hochflexibel, selbstanpassend, abriebfest, frei von Cadmium, Formaldehyd, Halogen und Graphit, selbstverlöschend nach DIN 75200 (FMVSS 302), gute Beständigkeit gegen Kraftstoffe, Mineralöle und Chemikalien	Properties:	Highly flexible, self-adapting, resistant to abrasion, free of cadmium, formaldehyde, halogen and graphite, self-extinguishing acc. to DIN 75200 (FMVSS 302), good resistance to fuel, mineral oil and chemicals
Ausführung:	gebündelter Wickelstrang	Execution:	bundled winding strand
Einsatztemperatur:	-55° C / +150° C	Operation temperature:	-55° C / +150° C

Orange			Orange	
NW	Ø min mm	Ø max mm	Art.-No.	
8	5	8	6879.80.08	50
13	10	13	6879.80.13	50
16	13	16	6879.80.16	50
19	16	19	6879.80.19	50
25	22	25	6879.80.25	25
29	26	29	6879.80.29	25
32	29	32	6879.80.32	25
38	35	44	6879.80.38	25
50	44	50	6879.80.50	25



Farbe Orange für Elektrofahrzeuge	Colour orange for electric vehicles
Nominaler Innendurchmesser mit einer Überlappung von 25% / 90°	Nominal inner diameter with 25% / 90° overlap

1
2
3
4
5
6
7
8
9
10
11
12
13
14
15

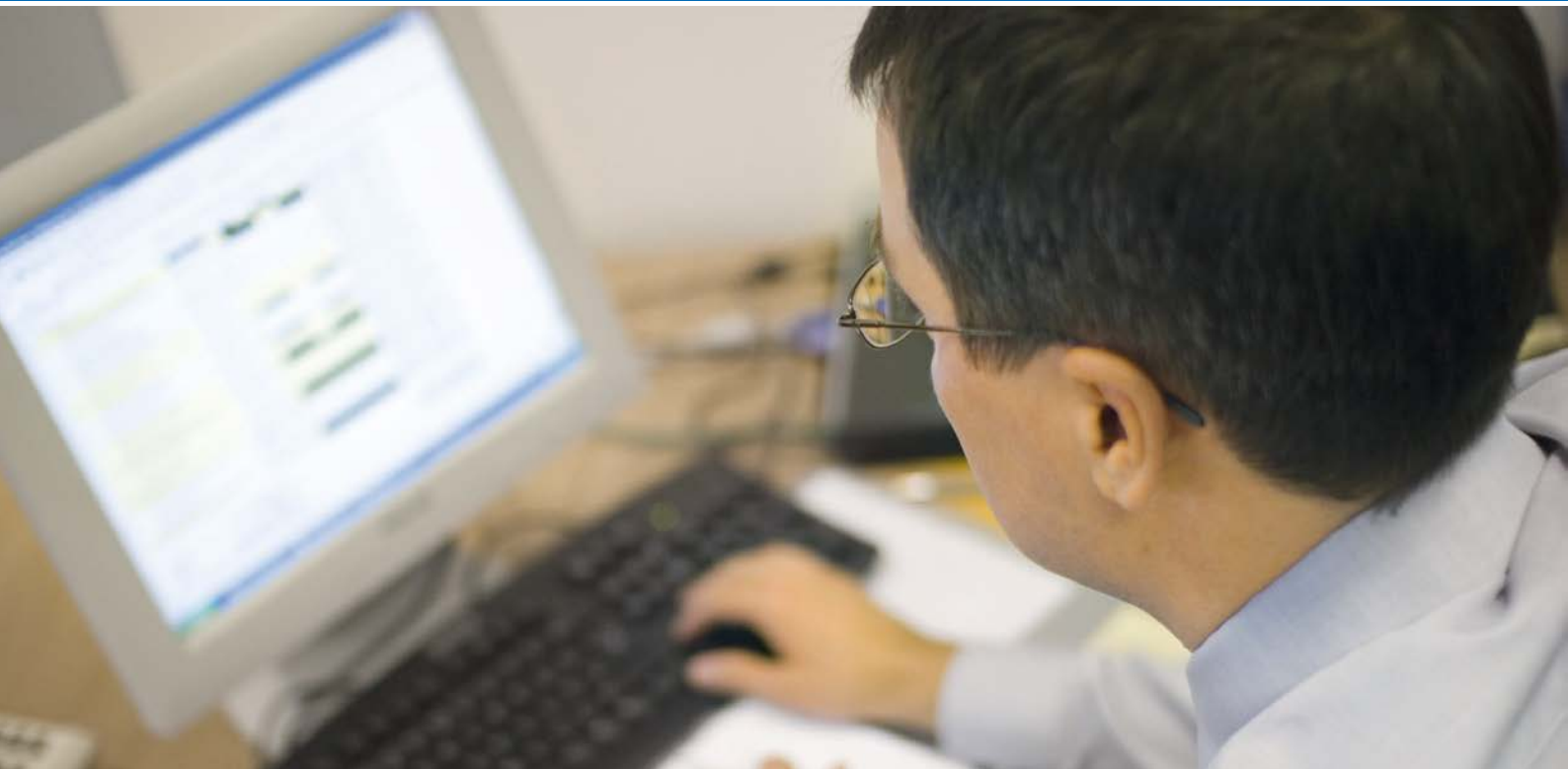

- AGRO online
- Dynamische Produktsuche
- Merkliste
- Produktvergleich
- 3D-Ansicht
- CAD-Download
- Anfragefunktion

- AGRO online
- Dynamic product searching
- Memo list
- Product comparison
- 3D views
- CAD download
- Inquiry function

Auf unserer Website www.agro.ch bieten wir Ihnen **umfangreiche Informationen**.

Dank der **benutzerfreundlichen Navigation** und der **dynamischen Suchfunktionen** finden Sie die zu Ihrer Anwendung passenden Kabelverschraubungen hier in Sekundenschnelle.

Die **Produktansicht** zeigt alle technischen Daten sowie Zulassungen auf einen Blick. Aus jeder Produktansicht können Sie ein **Produktdatenblatt im PDF-Format** generieren.

Die gewählten Produkte können Sie in einer **Merkliste** speichern, welche eine Vielfalt an Funktionen bietet – z. B. Produktvergleich, Medien-Download oder Anfrageformular.

Die **CAD-Daten** zu allen Kabelverschraubungen sind online hinterlegt. Diese können entweder in einer dynamisch generierten **3D-Ansicht** angezeigt werden oder lassen sich in allen gängigen CAD-Formaten an die eigene E-Mail-Adresse senden.

Wir freuen uns auf Ihren virtuellen Besuch auf unserer Website!

You can find **comprehensive information** on our website, www.agro.ch.

The **user-friendly navigation** and the **dynamic search functions** enable you to find the products you need for your application in just a few seconds.

The **product overview** for each product shows all the technical information including technical approvals at a glance. You can generate a **pdf-format product data sheet** from every product overview.

In addition, you can save the products you need for your application in a **memo list** which gives you a wide range of functions, for example product comparisons, media download or an inquiry form.

We have put online the **CAD data** on all cable glands. The data can be displayed as a dynamically-generated **3D view** or can be sent to an email address in all standard CAD formats.

We look forward to your virtual visit to our website!



YouTube

Neu: Produkt-Animationen für Ihr Smartphone

Der QR-Code ermöglicht Ihnen einen schnellen und bequemen Zugriff auf unsere informativen Produkt-Animationen mit Ihrem Smartphone. Probieren Sie es aus!

New: Product animations for your smartphone

The QR code gives you fast, easy access to our informative product animations via your smartphone. Try it - you'll like it!



Spezielle Einführungslösungen Special entry solutions	294 - 295	1
Prüfzeichen Certification marks	296 - 297	2
Brandschutz für Schienenfahrzeuge nach EN 45545 Fire protection for railway vehicles according to EN 45545	298 - 299	3
Progress® Baukasten und AGRO Sonderlösungen Progress® Modular assembly system and AGRO special solutions	300 - 305	4
AGRO Prüftechnik AGRO Test laboratory	306 - 309	5
Sonderlösung für very heavy duty Special solution for "very heavy duty" application	310	6
Montageanleitungen Kabelverschraubungen Assembly instructions for cable glands	311 - 316	7
Gewindetabelle Threads table	317	8
Verzeichnis der Schutzarten (IP) List of Protection Classes (IP)	318	9
Materialübersichtstabellen Materials overview	319 - 222	10
Vergleich rostfreier und säurebeständiger Stahl A4 Comparison of A4 stainless and acid-resistant steels	323	11
Suchhilfen Search help	324 - 346	12
Anfrage für eine Speziallösung Request for a special solution	347	13

1
2
3
4
5
6
7
8
9
10
11
12
13
14



AGRO Kabelverschraubungen – die Alleskönner

Unser Standard-Sortiment an Kabelverschraubungen ist darauf ausgerichtet, ideale Einführungslösungen für Standardapplikationen zu bieten.

In manchen spezifischen Situationen muss die Kabelverschraubung den konkreten Anforderungen angepasst werden. Sehr oft ist es ausreichend, die Bestandteile des Progress® Baukastens individuell zusammenzustellen, um eine passende Lösung zu finden. Alle Einzelkomponenten des Baukastens sind kompatibel und können frei kombiniert werden.

Manche Montagesituationen oder Anforderungen sind jedoch besonders und es muss eine spezifische Einführungslösung gefunden werden. Auch für diesen Fall bietet der Progress® Baukasten die notwendige Flexibilität für schnelle und kostengünstige Einzelanfertigungen.

Kabelverschraubungen können auf jeder Stufe des Baukastens den Anforderungen entsprechend individualisiert werden.

Wir können alle technischen Gewinde in verschiedenen Materialien umsetzen und Dichteinsätze im Hinblick auf Anzahl, Form der Durchführungen und Materialwahl so individualisieren, dass den Anforderungen genau entsprochen wird. Langfristige Funktionssicherheit ist das oberste Ziel.

Sprechen Sie mit uns, wenn Sie Kabel in Ihr Gerät einführen müssen. Wir finden eine einfachere, rationellere oder schönere Lösung für Sie!

AGRO cable glands – the all-rounders

Our standard range of cable glands is designed to provide ideal cable entry solutions for standard applications.

In some specific situations, the cable gland must be adapted to special requirements. It is often possible to find a suitable solution simply by assembling the Progress® system's components in an appropriate way. All individual components of the system are compatible and can be easily combined.

However, in some cases, a special cable entry solution must be developed. In this case too, the modular design of the Progress®-system enables any single component of the cable gland to be customised individually, making the process fast and cost-effective.

We can supply cable glands with any required thread type, in various materials and customise sealing inserts in terms of material and of number and shape of cable entries in order to meet all requirements. Long-term reliability is the top priority.

Contact us, if your equipment needs cable entries. We will find a nicer, simpler or more efficient solution for you!

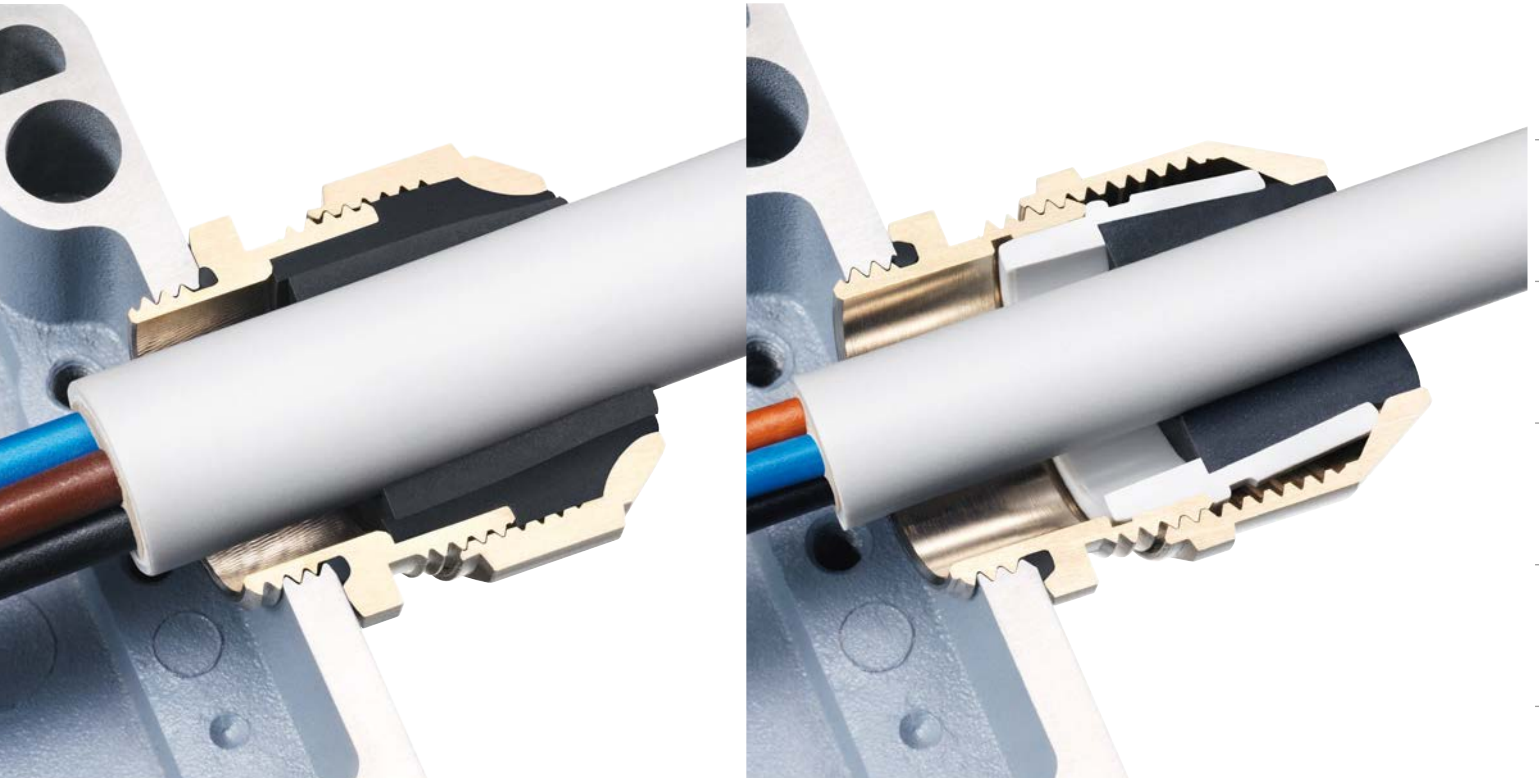

Progress® in Messing, Stahl oder Kunststoff

AGRO Kabelverschraubungen Progress® mit herausragender Kompressionstechnik sorgen für eine hohe Dichtigkeit und eine äusserst kabelschonende Zugentlastung auch bei dynamischen Belastungen. Dichteinsätze für spezifische Anwendungen wie Bahnapplikationen nach EN 45545, im Trinkwasserbereich, in der Lebensmittel- und Reinraumtechnologie oder bei hohen Temperaturen sind standardmässig verfügbar.

- 1 Kurze, lange oder Spezial-Anschlussgewinde in metrischer, Pg-, Gasrohr- oder NPT-Ausführung
- 2 Hoher Verdrehenschutz dank Längsrandrierung im Dichteinsatz
- 3 Zweiteilige Dichteinsätze erweitern den Klemmbereich
- 4 Auf den Dichteinsatz abgestimmte Innenkonturen sorgen für eine zielgerichtete Verformung des Dichteinsatzes und garantieren die Schutzart IP 68 bis 10 bar sowie IP 69



Progress® in brass, steel or synthetic material

The outstanding compression technology of AGRO Progress® cable glands ensures effective sealing and excellent cable-protecting strain relief, also for dynamic loads. Sealing inserts for special applications such as railway (EN 45545), drinking water, food industry, cleanroom and high-temperature applications are available as standard.

- 1 Short, long or special entry threads (metric, PG, gas pipe or NPT)
- 2 High anti-rotation protection thanks to longitudinal grooves in the sealing insert
- 3 Two-piece sealing inserts for larger clamping range
- 4 Inner contours matched to the sealing insert cause the desired deformation ensuring sealing performance in compliance with protection class IP 68 up to 10 bar and IP 69

Syntec® in Messing oder Kunststoff

Kabelverschraubungen Syntec® sind mit ihrer innovativen Lamellentechnik speziell geeignet für den flexiblen und sicheren täglichen Einsatz. Die Vorfixierung der Kunststoff-Druckmutter erleichtert Überkopf-Montagen.

- 1 Kurze oder lange Anschlussgewinde in metrischer, Pg- oder NPT-Ausführung
- 2 Elastische und umweltbeständige Dichtringe garantieren die Schutzart IP 68
- 3 Die Lamellengeometrie mit beweglichen Gelenklamellen ermöglicht das Einführen verschiedener Kabeldurchmesser bei hervorragender Zugentlastung und exzellentem Verdrehenschutz
- 4 Der grossflächige Sechskant der Druckmutter der Kunststoffausführung bietet sicheren und festen Halt



Syntec® in brass or synthetic material

Syntec® cable glands with their innovative lamellar technology are particularly suitable for flexible, reliable everyday use. The pre-fixation of the synthetic compression nut facilitates easy overhead installation.

- 1 Short or long entry threads (metric, PG or NPT)
- 2 Elastic and environmentally resistant sealing rings ensure protection class IP 68
- 3 Lamellar technology for cable gripping facilitates the insertion of cables of varying diameters and ensures outstanding strain relief and anti-rotation protection
- 4 The large-area hexagonal surface of the compression nut of the plastic version offers reliable and secure grip



SEV

Das SEV-Bewilligungszeichen wird auf Grund bestandener Prüfungen bei ElectroSuisse vom ESTI erteilt. Grundlage für Kabelverschraubungen ist hierbei die europäische Norm EN 62444.

SEV

The SEV mark of approval is awarded by ESTI on the basis of tests conducted by ElectroSuisse. European standard EN 62444 forms the basis for cable glands.



VDE

Das VDE-Zeichen kennzeichnet die Konformität mit den VDE-Bestimmungen bzw. europäischen oder international harmonisierten Normen und bestätigt die Einhaltung der Schutzanforderungen der zutreffenden Richtlinien. Das VDE-Zeichen steht für die Sicherheit des Produktes hinsichtlich elektrischer, mechanischer, thermischer und sonstiger Gefährdung.

VDE

The VDE certification mark signals conformity with the VDE provisions and European or internationally harmonised standards and confirms compliance with the protection requirements of the applicable guidelines. The VDE mark signifies the safety of the product in terms of electrical, mechanical, thermal and other hazards.



UKCA

Die UKCA-Kennzeichnung (UK Conformity Assessed) ist die neue Produktkennzeichnung, die verwendet werden muss, um nachzuweisen, dass bestimmte Waren den neuen Vorschriften des Vereinigten Königreichs entsprechen. Sie dient als Nachweis der Konformität bestimmter Waren mit den gesetzlichen Anforderungen des Vereinigten Königreichs und wird beim Inverkehrbringen dieser Waren in Großbritannien verwendet. Sie gilt für alle Waren, für die bisher eine CE-Kennzeichnung erforderlich war.

UKCA

The UKCA (UK Conformity Assessed) mark is the new product labelling that must be used to verify that certain goods comply with the United Kingdom's new regulations. It serves as proof of compliance of certain goods with the UK's legal requirements and is applied when placing these goods on the market in Great Britain. It applies to all goods for which a CE marking was previously required.



C-UL / US Listing Zeichen

Dieses Prüfzeichen wird bei Produkten verwendet, die auf kanadischen und U.S.-Märkten vertrieben werden. Es weist darauf hin, dass die kanadischen und die U.S.-Anforderungen für klassifizierbare Produkte erfüllt wurden.

C-UL / US Listing Mark

This approval mark is used for products that are sold in the US and Canadian markets. It indicates that the US and Canadian requirements for classifiable products have been fulfilled.



Recognized Component Zeichen für Kanada und die USA

Das Recognized Component Mark von UL darf für Komponenten verwendet werden, die Bestandteil eines grösseren Produktes oder Systems sind. Diese sind von UL gemäss kanadischen und U.S.-Anforderungen zertifiziert.

Recognized Component Mark for Canada and the USA

The UL Recognized Component Mark can be used for components that are part of a larger product or system. These are certified by UL in accordance with US and Canadian requirements.



CCC

CCC steht für China Compulsory Certificate. Das chinesische CCC ist vergleichbar mit anderen Zertifizierungen zur Standardisierung der Produktqualität. Im Rahmen der Zertifizierung werden Produkttests und Werksaudits durchgeführt. Die CCC-Zertifizierung basiert auf den nationalen, chinesischen GB Standards und Durchführungsbestimmungen (Implementation Rules). Die zertifizierungspflichtigen Produkte dürfen erst nach China importiert, in China verkauft und in Geschäftsaktivitäten in China verwendet werden, nachdem eine CCC-Zertifizierung des Produktes beantragt und erteilt wurde.

CCC

CCC stands for China Compulsory Certificate. The Chinese CCC is comparable to other certifications used to standardise product quality. Product tests and factory audits are carried out as part of the certification. The CCC certification is based on the national Chinese GB standards and implementation rules. The products subject to certification may only be imported into China, sold in China, and used in business activities in China, after a CCC certification of the product has been applied for and granted.

Det Norske Veritas (DNV)

Det Norske Veritas (DNV) ist eine Schiffsklassifikations-Gesellschaft in Form einer Stiftung. Sie klassiert und erteilt Zertifikate zum unbedenklichen Einsatz von Produkten auf Schiffen. DNV wurde 1864 in Oslo gegründet.

Det Norske Veritas (DNV)

Det Norske Veritas (DNV) is a ship classification society in the form of a foundation. It classifies and issues certificates relating to the safe use of products on ships. DNV was founded in Oslo in 1864.



1

IEC Ex

Das IEC Ex-Prüfzeichen ist eine spezielle Kennzeichnung für Explosionsschutz-Einrichtungen. Es bedeutet, dass Einrichtungen, Schutzsysteme oder Bauteile den Anforderungen der internationalen und europäischen Norm entsprechen, die mit der Richtlinie 2014/34/EU (ATEX-Direktive, benannt nach der französischen Bezeichnung „ATmosphere EXplosible“) harmonisiert sind.



3

IEC Ex

The IEC Ex mark of conformity is a special marking for equipment used in explosive atmospheres. It means that equipment, protective systems or components meet the requirements of the international and European standards which are harmonised with Directive 2014/34/EC (the ATEX directive, named after the French "ATmosphere EXplosible" certification).

4

RoHS

„Restriction of the use of certain Hazardous Substances in electronic equipment“ ist der Titel der EU-Richtlinie 2002/95/EG. Sie verbietet ab 1.7.2006 im gesamten Gebiet der EU den Verkauf von elektrischen Geräten, welche mehr als nur Spuren von Blei, Cadmium, Chrom VI, Quecksilber oder von polybromierten Flammschutzmitteln PBB/PBDE enthalten.



5

RoHS

"Restriction of the use of certain Hazardous Substances in electronic equipment" is the title of EC Directive 2002/95/EC. With effect from 1 July 2006, it forbids the sale of electric equipment which contain more than traces of lead, cadmium, chromium(VI), mercury or polybrominated flame retardants (PBBs and PBDEs) throughout the entire EC.

6

REACH

Die Verordnung (EG) Nr. 1907/2006 (REACH-Verordnung) ist eine EU-Chemikalienverordnung, die am 1. Juni 2007 in Kraft getreten ist. REACH steht für Registration, Evaluation, Authorisation and Restriction of Chemicals. Das REACH-System basiert auf dem Grundsatz der Eigenverantwortung der Industrie. Innerhalb des Geltungsbereiches dürfen nur noch chemische Stoffe in Verkehr gebracht werden, die vorher registriert worden sind.



8

REACH

Regulation (EC) No. 1907/2006 (REACH Regulation) is an EU chemicals regulation that came into force on June 1st, 2007. REACH stands for Registration, Evaluation, Authorisation and Restriction of Chemicals. The REACH system is based on the principle of self-responsibility of the industry. Within the regulation's scope, only chemical substances that have been already registered may be placed on the market.

9

EN 45545

Die EN 45545 setzt sich aus mehreren Teilen zusammen und definiert den Brandschutz in Schienenfahrzeugen. Teil 1 umfasst allgemeine Regeln, Teil 2 (EN 45545-2) ist in Bezug auf gefährliche Rauchgase sehr wichtig und Teil 3 (EN 45545-3) definiert den Feuerwiderstand von Feuerschutzabschlüssen (Raumabschlüsse).



10

EN 45545

The EN 45545 standard consists of several parts and specifies rules relating to fire protection of railway vehicles. Part 1 covers general requirements, part 2 (EN 45545-2) is very important in relation to dangerous smoke gases and part 3 (EN 45545-3) defines the fire resistance requirements for fire barriers.

11

NFPA

Die amerikanische Norm NFPA 130 definiert die zulässigen Werte für die Wärmefreisetzung und Rauchentwicklung (ASTM E 1354) sowie die Rauchgas-Toxizität (SMP 800) für Produkte, welche in Schienenfahrzeugen zur Anwendung kommen.



13

NFPA

The American standard NFPA 130 specifies permitted values for heat release and smoke emission (ASTM E 1354) as well as smoke toxicity (SMP 800) of products for use in rolling stock applications.

14

AGRO Kabelverschraubungen sind nach EN 45545-2 zertifiziert

AGRO cable glands are certified according to EN 45545-2

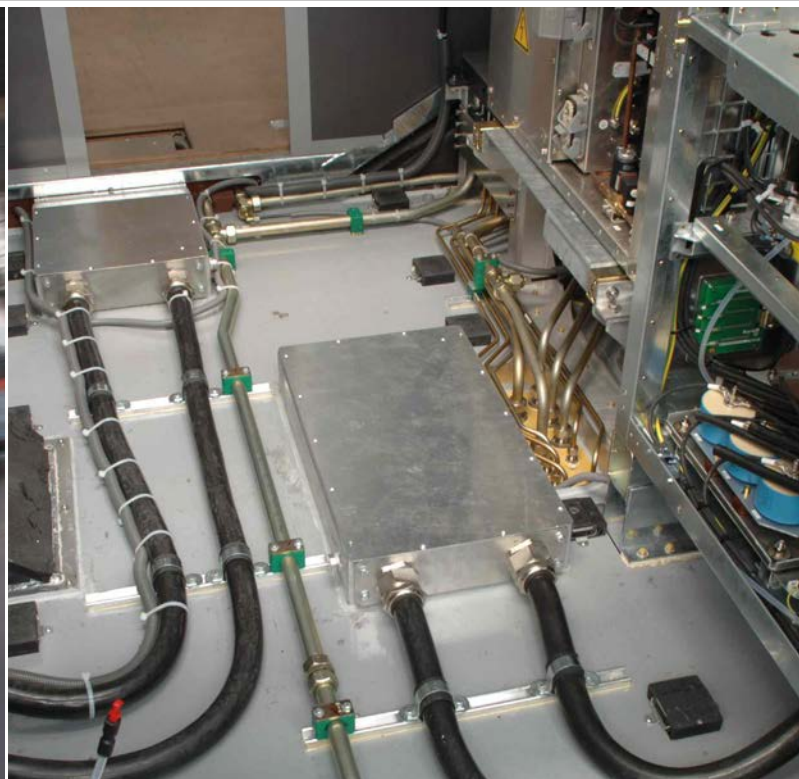

AGRO Progress® bedenkenlos für Schienenfahrzeuge

AGRO Progress® Kabelverschraubungen aus Metall können bedenkenlos für alle Anwendungen und Anordnungen im Schienenfahrzeugbereich eingesetzt werden. Dies bescheinigt das neue Zertifikat.

Die herausragende Progress® Kompressionstechnik sorgt für eine hohe Dichtigkeit und eine äusserst kabelschonende Zugentlastung auch bei dynamischen Anwendungen. Standard- und EMV-Kabelverschraubungen mit dem entsprechenden Zubehör bilden das Basissortiment für nahezu alle Anwendungen. AGRO fertigt bei Bedarf auch zertifizierte Lösungen gemäss Anforderungen der Kunden.

Beste Resultate bei Prüfungen nach EN 45545-2 (Komponenten)

Die Progress® Dichteinsätze sind aus einem speziellen TPE gefertigt und sind im anspruchsvollsten **Hazard Level 3** zertifiziert.

Die geforderten Werte für Hazard Level 3 wurden sowohl im Ausen- als auch im Innenbereich deutlich übertroffen:

AGRO Progress® - the ideal solution for rolling stock

AGRO Progress® metal cable glands can be used with confidence for any rolling stock application, in any arrangement, as has been recently certified.

The outstanding Progress® compression technology ensures tight seals and offers cables exceptional damage-preventing strain relief, even in dynamic applications. A comprehensive range of standard and EMC cable glands and accessories offers a solution for almost any application. Where the need arises, AGRO also delivers certified solutions according to customer requirements.

Best results in testing according to EN 45545-2 (Components)

The seal inserts of Progress® cable glands are made from a special TPE and certified to the demanding **Hazard Level 3**.

The stipulated values for Hazard Level 3 were exceeded, for both indoor and outdoor areas:

	Normwert für HL 3 aussen Requirement for HL 3 outdoor	Normwert für HL 3 innen Requirement for HL 3 indoor	AGRO Resultat AGRO result
Sauerstoffindex Oxygen index	Min. 32%	Min. 32%	39%
Rauchgasdichte Ds Smoke gas density Ds	Max. 300	Max. 150	110
Toxizität CIT Toxicity CIT	Max. 1.5	Max. 0.75	0.16

Kabelverschraubungen zertifiziert für den Einsatz in Schienenfahrzeugen

Cable glands certified for rolling stock applications



Material: Messing vernickelt
Material Dichteinsatz: Spezial AGRO TPE
Farbe Dichteinsatz: Hellgrau RAL 7035
Gewinde: M12 bis M63
Pg 7 bis Pg 48
Einsatztemperatur: -50°C / +105°C
Schutzart: IP 68 / IP 69 K
Weitere Normen: EN 62444

Material: Nickel-plated brass
Material of sealing insert: Special AGRO TPE
Colour of sealing insert: Light grey RAL 7035
Threads: M12 to M63
Pg 7 to Pg 48
Temperature range: -50°C / +105°C
Protection class: IP 68 / IP 69 K
Further standards: EN 62444



AGRO Kabelverschraubungen sind nach EN 45545-3 zertifiziert

AGRO cable glands are certified according to EN 45545-3



Ausgangssituation / initial situation



nach 10 min. / after 10 min.

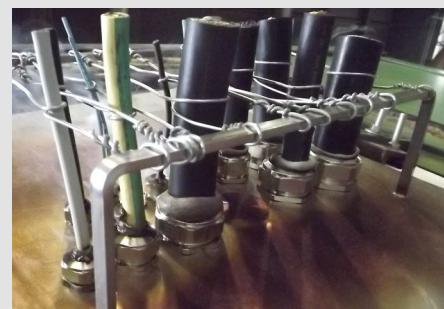

nach 20 min. / after 20 min.



nach 30 min. / after 30 min.



nach 35 Minuten / after 35 min.



nach 44 min. / after 44 min.

Vorgaben der EN 45545-3 übertreffen!

Die EN 45545-3 definiert die Anforderungen an den Feuerwiderstand für Feuerschutzabschlüsse. Ziel der EN 45545-3 ist es, die Brandausbreitung durch Materialanforderungen zu begrenzen. Wenn Kabel durch Feuerschutzabschlüsse geführt werden, gelten diese Anforderungen auch für Kabelverschraubungen.

Um festzustellen, ob der geforderte Feuerwiderstand erreicht wird, werden die Komponenten in einem Prüfofen in Hinblick auf die Kriterien Raumabschluss, Wärmedämmung und Strahlenemission geprüft.

AGRO Progress® Kabelverschraubungen aus Metall übertreffen die Vorgaben der EN 45545-3 bei weitem und erreichen die sehr hohe Feuerwiderstandsklasse E30. Dies bedeutet, dass die Dichteinsätze mindestens 30 Minuten lang dicht sind und einen Flammenübertrag auf die dem Feuer abgewandte Seite verhindern. Es bilden sich keine Spalten. Sie können aus brandschutztechnischer Sicht bedenkenlos in allen Schienenfahrzeugen eingesetzt werden.

Exceeding the demands of EN 45545-3!

EN 45545-3 defines the requirements for fire resistance of fire barriers. The aim of EN 45545-3 is to limit fire spread by specifying the performance of materials and components. If cables are routed through fire barriers, the requirements apply also to the cable glands used.

In order to establish whether or not the required fire resistance is achieved, components are tested in a testing furnace with respect to requirements for fire barrier, thermal insulation and radiation emission.

AGRO Progress® metal cable glands easily exceed the requirements of EN 45545-3 and satisfy the very high demands of fire resistance class E30. This means that the seal inserts remain impervious and prevent the spread of fire through the gland for at least 30 minutes. They do not crack or fissure. From a fire protection perspective, they can be used without hesitation in all railway vehicles.



EN 45545-3
E30

	Einbaulage vertikal Vertical installation	Einbaulage horizontal Horizontal installation	Klassierung Classification
AGRO Resultat AGRO result	44 min.	41 min.	E30

Der Brandversuch wurde durchgeführt mit AGRO Progress® Kabelverschraubungen Messing vernickelt und Dichteinsätzen aus Spezial AGRO TPE, Größen M16 bis M50, sowie mit Multi-Kabelverschraubungen und Verschlusschrauben.

Fire testing was carried out using AGRO Progress® nickel-plated brass cable glands and seal inserts of Special AGRO TPE, sizes M16 to M50, and with multi-cable glands and locking plug.

Progress®: Der Baukasten – Messing

Progress®: Modular assembly system – nickel-plated brass

Der modulare Aufbau unserer Kernserie Progress® ist eine ihrer ganz grossen Stärken. Die Bauteile sind aufeinander abgestimmt und können frei kombiniert werden. Kundenspezifischen Anforderungen kann flexibel, pragmatisch und schnell entsprochen werden. Wir kombinieren für Sie das passende Ober- und Unterteil mit dem richtigen Dichteinsatz und finden so die effektive und effiziente Lösung für Ihre Montagesituation.

The modular design of our Progress® range is one of its great strengths. The components are designed with the others in mind, and can be freely combined with each other. Customer-specific requirements can be flexibly, practically and quickly met. We will combine the most suitable upper and lower parts with the right sealing insert for you, and thus deliver the most effective, most efficient solution for your needs.

Standard Oberteile

Standard upper parts



Standard Dichteinsätze

Standard sealing inserts



Kurzer ein- oder zweiteiliger Dichteinsatz in NBR, TPE, Spezial TPE nach EN 45545 oder FPM (temperaturbeständig)

Short one- or two-piece sealing insert made of NBR, TPE, special TPE according to EN 45545 or FPM (heat resistant)

Langer durchgehend isolierender Dichteinsatz in NBR, TPE, Spezial TPE nach EN 45545, ein oder zweiteilig

Long one- or two-piece overall length insulating sealing insert made of NBR, TPE or special TPE according to EN 45545

Für die gängigsten Kabeldurchmesser sind Dichteinsätze für die Durchführung mehrerer Kabel verfügbar

For the most common cable diameters, sealing inserts are available for the entry of several cables at once

Standard Unterteile

Standard lower parts



Wenn die Anforderungen ganz spezifisch sind, können wir diesen auf jeder Stufe des Progress®-Baukastens mit individualisierten Komponenten gerecht werden: sowohl Drehteile als auch Dichteinsätze können optimal auf die Kundenbedürfnisse abgestimmt werden. Eine optimale Lösung bietet eine geringere Montagezeit und ein Gewinn an Sicherheit.

Where requirements are very specific, we can custom-design each individual component of our Progress® cable glands accordingly: both metal parts and sealing inserts can be tailored to optimally meet your needs, reducing installation time and enhancing reliability.

Kundenspezifische Oberteile Customised upper parts



Oberteile können im Hinblick auf die Bauform und das Gewinde individualisiert werden. In Zusammenarbeit mit den Kunden wird ein Bauteil entwickelt, welches den individuellen Anforderungen am Besten entspricht und den optimalen Nutzen bietet.

Upper parts can be customised for shape and thread. By working closely with the customer, a component is developed which best meets individual requirements and optimises user benefits.

Individualisierte Dichteinsätze Customised sealing inserts



Dichteinsätze können auf der Ebene der Form und Anzahl der Durchführungen und auf der Ebene der Materialwahl individualisiert werden. Wir bearbeiten folgende Materialien:

Sealing inserts can be customised for shape and number of feedthroughs and also with regard to the selection of material. We work with the following materials:

- NBR
- TPE-V
- FPM
- Silikonkautschuk / silicone rubber
- EPDM
- TPE
- HNBR

Kundenspezifische Unterteile Customer-specific lower parts

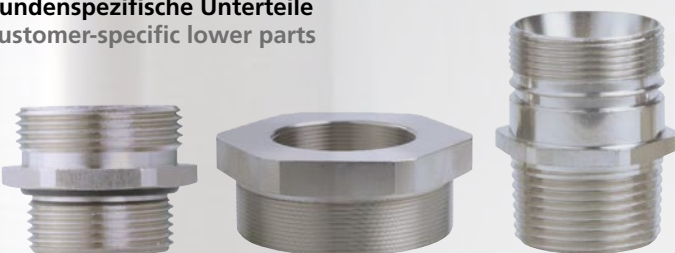

Unterteile können im Hinblick auf die Bauform und das Anschlussgewinde individualisiert werden. Sämtlichen Größen und kundenspezifischen Längen sind in folgenden Gewindearten möglich:

Lower parts can be customised for shape and entry thread. All sizes and customer-specific lengths are available with the following types of thread:

- metrisch / metric
- Pg
- NPT
- Gasrohrgewinde / gas pipe

Sonderlösung Schienenfahrzeug

Special solutions for railway vehicles

Die Anforderungen

- EMV-gerechte Einführung von 6 ungeschirmten Kabeln
- Verbindung Stromrichter-Trafo
- Schutzart IP 68 innen und aussen. Dadurch wird verhindert, dass Kondenswasser, welches sich möglicherweise innerhalb des Schlauches bildet, in den Traforaum eindringt

Die Lösung von AGRO

- Progress®-Spezialverschraubung M75 mit geschlitztem Multi-Dicht-einsatz zur leichteren Kabelmontage
- Kombiniert mit Metallschutzschlauch

The requirements

- EMC-compatible feedthrough of six unshielded cables
- Connection from power rectifier to transformer
- Protection class IP68 inside and out. This prevents condensation water which could possibly build up inside the conduits from making its way into the transformer compartment

The AGRO solution

- Progress® M75 special cable gland with slittable multi-sealing insert for easier installation
- Combined with metal conduit

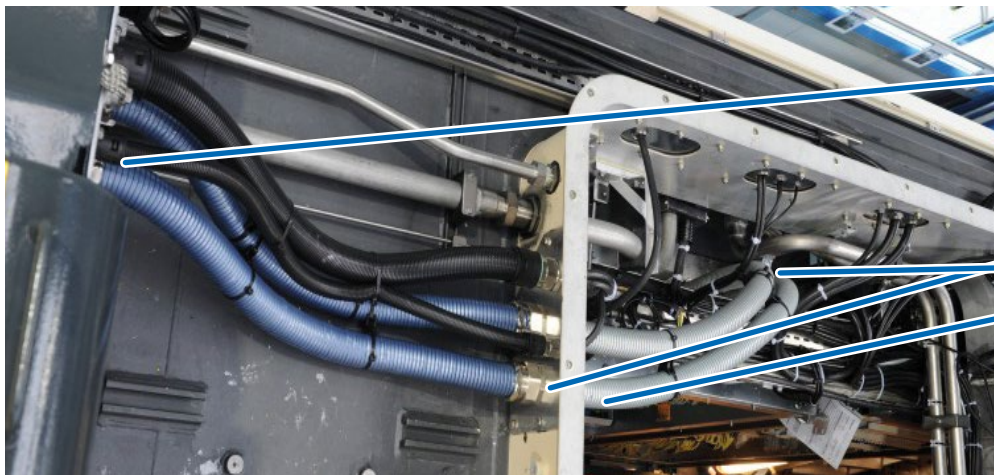

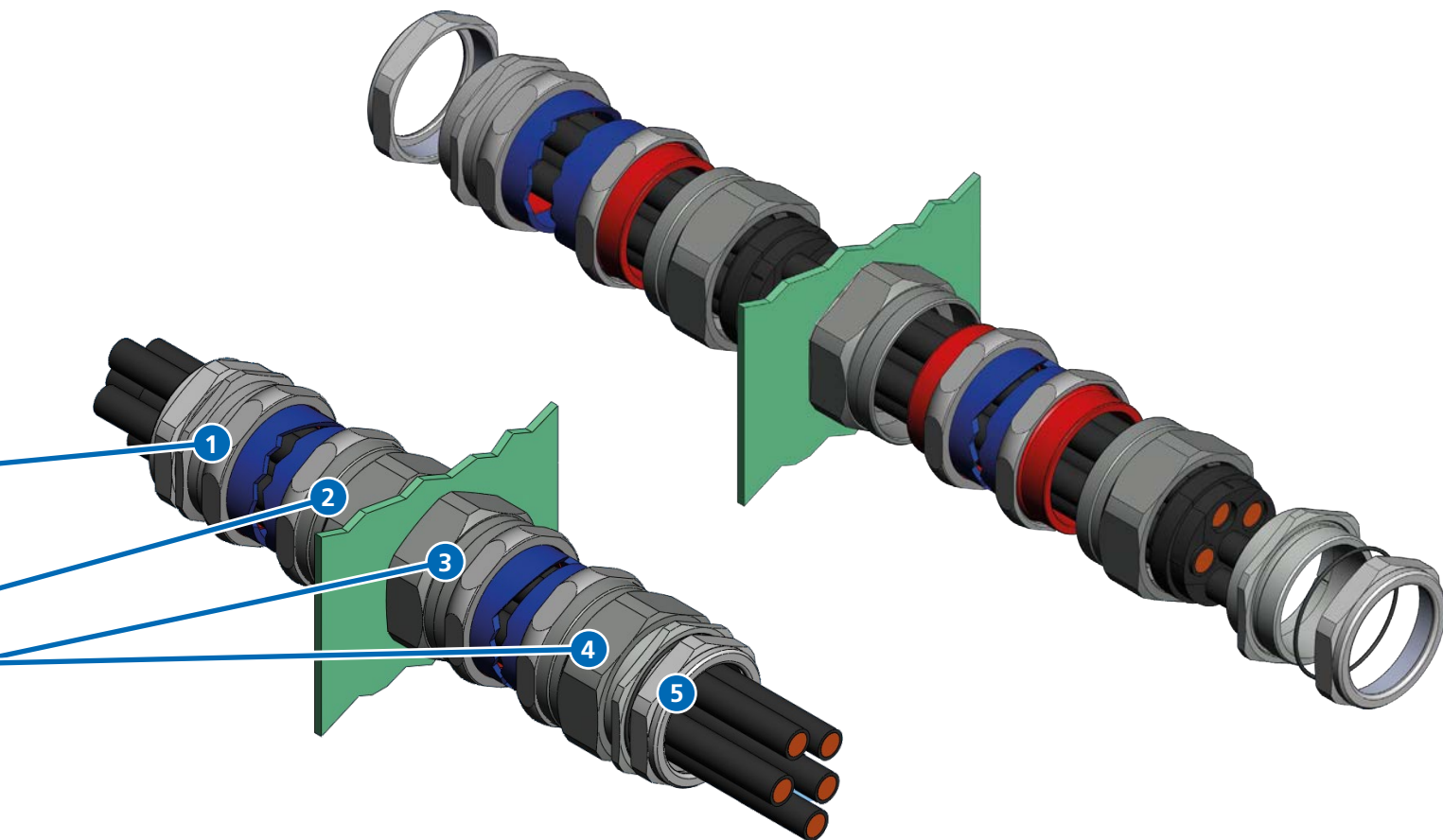

- 1 Schlauchverschraubung zur Befestigung des Metall-Kabelschutzschlauches. Innerhalb des Schutzschlauches werden sechs Stromkabel geführt. Der Metallschutzschlauch funktioniert über seine Verbindung mit den Gehäusen aus Metall als äußerer EMV-Schutz
- 2 Kombi-Schlauchverschraubung mit Progress® Multi-Dichteinsatz zur dichten Einführung der Kabel in den Traforaum (Schutz vor Feuchtigkeit von aussen)
- 3 Schlauchverschraubung zur Aufnahme des Metallschutzschlauches (Weiterführung des EMV-Schutzes)
- 4 Kombi-Schlauchverschraubung (identisch mit 2) zur Einführung der Kabel in den Trafo (Schutz vor Feuchtigkeit von innen)
- 5 Gegenmutter zur Befestigung der Kombi-Schlauchverschraubung

- 1 Conduit gland to secure the metal conduit. Six power cables are routed through the conduit. The metal conduit functions as an exterior EMC shield through its connection with the metal enclosures
- 2 Combination conduit gland with Progress® multi-sealing insert for sealed cable entry into the transformer compartment (protection from outside moisture)
- 3 Conduit gland to accept the metal conduit (extension of EMC protection)
- 4 Combination conduit gland (identical to #2) for cable entry into the transformer compartment (protection from interior moisture)
- 5 Locknut to secure the combination conduit gland

Sonderlösung Kabelverschraubung Knabberschutz

Rodent-proof special cable gland solution



© ABB

Wenn Nager zum Sicherheitsrisiko werden

Manch einer kennt das Phänomen aus eigener Erfahrung: Das Auto will sich am Morgen nicht starten lassen und der Reparaturdienst stellt fest, dass Gummiteile von Mardern weggefressen worden sind. Marder, Nager und Vögel lieben Gummi. Die Konsistenz und der Duft von Gummi zieht Kleintiere an und sie knabbern ihn an. Frei geknabberte Kabel führen zu Kurzschlüssen und Funktionsstörungen. Wenn ummantelte Kabel in einem natürlichen Umfeld eingesetzt werden, so muss mit einem Nagerschaden gerechnet werden und entsprechende Vorsichtsmaßnahmen sind sinnvoll.



Nagerschaden an Kabel /
Rodent damage to a cable

ABB baut gasisolierte Schaltanlagen, die in der ganzen Welt unter unterschiedlichsten Umweltbedingungen eingesetzt werden. Möglichen Schäden durch Nager wird standardmässig vorgebeugt, indem die Kabel, welche Generatorschutzschalter und Steuer-schrank verbinden, in einem mit Polyurethan ummantelten flüssigkeitsdichten Schlauch mit Stahlwendel geführt werden. Zur IP 68 dichten Einführung der im Schlauch geführten Kabel entwickelte AGRO in Zusammenarbeit mit ABB eine individualisierte Lösung, welche eine feuchtigkeitsdichte Verbindung von Schlauch- und Kabelverschraubung sowie einen sicheren EMV-Abgriff ermöglicht. Mit dieser Lösung werden zwei Probleme auf einmal gelöst: Die Kabelführung und -Einführung ist feuchtigkeitsdicht und vor Nagern geschützt.

When rodents become a safety risk

Many of us know the phenomenon from personal experience: the car just won't start in the morning and the mechanic finds that rubber parts have been gnawed away by martens. Just like martens, rodents and also birds love rubber. Small animals seem to be magically drawn to rubber by its consistency, or maybe its scent, and nibble away at it. Damaged cables can result in short circuits and loss of functionality. If shrouded cables are to be used in a natural setting, the risk of rodent damage should be recognised and appropriate precautions taken.



Nagersicherer Kabelschutz Progress® EMV Serie 85 /
Rodent-proof cable protection Progress® EMC Serie 85

ABB manufactures gas insulated switchgear that is used all around the world in the most varying environments. Possible damage by rodents is prevented, as standard, by the use of a polyurethane-sheathed, liquid-tight conduit with a steel coil to protect cables connecting generator circuit breakers and control cabinets. For the IP68-compliant entry of the cable in the conduit, AGRO developed, in cooperation with ABB, an individualised solution which facilitates a liquid-tight connection of conduit gland and cable gland and a reliable EMC connection. This solution solves two problems at once: the cable routing and the cable entry are liquid tight, and the cable is also protected from rodents.

Sonderlösung im längsten Eisenbahntunnel der Welt (Gotthard Basistunnel)

Special solution in the world's longest railway tunnel (Gotthard Base Tunnel)



Die Ausgangslage

Das Sicherheitsdispositiv im Gotthardtunnel ist hoch und sieht die permanente Überwachung der zirkulierenden Züge vor. In relativ kurzen Abständen überprüfen so genannte Achszählgeräte die Vollständigkeit des Zuges. Die Geräte sind den rauen Bedingungen im Tunnel sowie Steinschlag ausgesetzt.

Die Anforderungen

Die stromführenden Kabel sollten mit einem schlagfesten Schlauch vor Schotterschlag geschützt werden. Die Verbindung Kabelverschraubung-Schlauch sollte auf möglichst einfache Weise erfolgen.



Progress® mit Schlauchanschluss /
Progress® with conduit connection

Die Lösung von AGRO

Grundlage des Lösungsansatzes bildet eine Standard Progress® Kabelverschraubung. Sie wird ergänzt durch eine kundenspezifische Schlauchanschluss-hülse für die einfache und ausreißfeste Aufnahme für den Schutzschlauch.

Eine Verschlusskappe verschliesst die Kabeleinführung mit einer Dichtigkeit von IP 68, solange diese unbelegt bleibt.

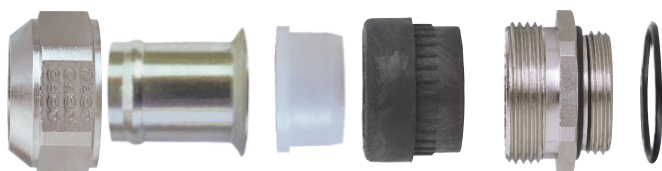

The situation

Safety arrangements in the Gotthard tunnel are extensive and provide for permanent monitoring of trains as they pass through. At relatively short intervals, so-called axle counters check the completeness of the train. The equipment is exposed to rough tunnel conditions, including stone impacts.

The requirements

The power cables should be protected from stone ballast by an impact-resistant conduit. The connection between cable gland and conduit should be as simple as possible.



Achszähler /
Axle counter

The AGRO solution

The solution is based on a standard Progress® cable gland. It is supplemented by a customised conduit connection sleeve for a simple and pullout-resistant connection of the protective conduit.

When not in use, a cap seals the cable entry to IP 68 requirements.



1
2
3
4
5
6
7
8
9
10
11
12
13
14
15



Glühdrahttest bei 850°C
Glow wire test at 850°C



Druckprüfung zur Ermittlung des IP Schutzes
Pressure test for the determination of the degree of IP protection

Das Arbeiten und Leben mit Strom birgt Risiken. Normen und staatliche Richtlinien wollen diese Risiken minimieren und Installateuren, Monteuren und zu guter Letzt auch dem Endnutzer mehr Sicherheit bieten.

Geprüfte und zertifizierte Produkte geben dem Installateur Sicherheit bei der Montage und die Gewissheit, dass das Produkt seine Funktion über viele Jahre erfüllen wird.

AGRO erfüllt die relevanten Anforderungen nach IEC EE OD-2048 und OD ECS 035 bzw. 037 für die Anerkennung von Prüfberichten im CTF/MTL-Verfahren. Unser Labor entspricht den anwendbaren Anforderungen aus der ISO/IEC 17025:2017 (Allgemeine Anforderungen an die Kompetenz von Prüf- und Kalibrierlaboratorien).

Hierdurch verfügt die AGRO AG über das nötige normative Wissen (IEC EN 60079-0,-1,-7,-31 / ATEX-IECEx / IEC 62153-4-3, IEC EN 60512-5-2 / 62444 / 60670-1, -21, -22 / 60529 / EN 50085-1, -2-1 sowie UL514B und NEMA 250), um Produkte schnell und rechtssicher zu prüfen.

Die Zulassungsstellen garantieren die Zertifizierungen von Prüfberichten aus dem auditierten AGRO Prüflabor. Unser Prüflabor wird deshalb mindestens einmal jährlich, angemeldet sowie unangemeldet, von den jeweiligen Zulassungsstellen überprüft/auditiert.

Working and living with electricity inevitably involves risks. Standards and government directives have the goal of minimising these risks and offering additional safety to electricians, installers and, of course, end users.

Products that have been tested and certified help ensure the technician's safety during installation. This testing also provides confidence that the product will perform its function for many years.

AGRO meets the relevant requirements according to IEC EE OD-2048 and OD ECS 035 or 037 for the recognition of test reports according to the CTF/MTL procedure. Our laboratory complies with the applicable requirements of ISO/IEC 17025:2017. (General requirements for the competence of testing and calibration laboratories.) As a result, AGRO AG has the necessary knowledge of applicable standards (IEC EN 60079-0,-1,-7,-31 / ATEX-IECEx / IEC 62153-4-3, IEC EN 60512-5-2 / 62444 / 60670-1, -21, -22 / 60529 / EN 50085-1, -2-1, UL514B and NEMA 250) to test products quickly and in compliance with legal requirements.

The accreditation bodies warrant the certification of test reports prepared by the audited AGRO testing laboratory. Our test laboratory is therefore checked/audited at least once a year by the responsible accreditation bodies – in some cases unannounced.



Video Prüflabor



Video Test Laboratory



Zugprüfung an einer Kabelverschraubung
Tensile test on a cable gland

Alles in allem kommen die Zulassungsstellen zu folgendem Schluss:

„Die Produkte von AGRO halten, was das Unternehmen verspricht“.

Overall, the accreditation bodies come to the following conclusion:

„AGRO products perform just as the company says they will“.

Im Mittelpunkt der Prüfung

Das erfolgreiche Bestehen der Prüfung durch die Zulassungsstellen gibt dem Konsumenten die Gewähr, dass der Hersteller eines Produktes über das notwendige normative Wissen verfügt und dass die Prüfeinrichtungen für die Durchführung von Prüfungen nach offiziellen Standards geeignet sind. Geprüft wurden unter anderem die IP-Druckprüfanlage (Schutzart IPX8 bis 10 MPa (100 bar)), die Spritz- und Strahlwasseranlage (IPX3 bis IPX6 und IPX9K) und die Zugprüfmaschinen bis 2.5 kN (250 kg) für das Prüfen von Kabelverschraubungen, Steckdeckeln, Lampendübeln und anderen Komponenten. Ebenso der Klimaschrank für das Durchführen von Wärmealterungen, die Einrichtung für die Schlagprüfungen, mit der die Widerstandskategorie von Kabelverschraubungen ermittelt wird, und das Testgerät, mit dem die Glühdrahtfestigkeit an Bauteilen nach IEC (650°C / 850°C) geprüft wird.

At the heart of the testing

Passing the testing of the accreditation bodies gives the consumer the assurance that the manufacturer of a product has the necessary knowledge of applicable standards and that the test equipment is suitable for carrying out tests according to official standards. The tests included the IP compression testing system (Protection Class IP X8 up to 10 MPa (100 bar)), the spray and jet water system (IPX3 to IPX6 and IPX9K) and the tensile testing machines up to 2.5 kN (250 kg) for testing cable glands, push-on covers, lamp boxes and other components. The same applies to the climatic exposure test cabinet for carrying out heat ageing, the device for impact tests to determine the resistance category of cable glands, and the equipment for testing the glow wire strength of components in accordance with IEC (650°C / 850°C).



Oil-Spray Test



Flexing Test

Eigens konstruierte Prüfeinrichtungen

Wir verfügen ebenfalls über eigens konstruierte Prüfeinrichtungen, welche es uns erlauben, **nach der amerikanischen UL514B zu prüfen**. Dies beinhaltet den Oil-Spray-, den Flexing- und den pull-out-Test sowie die Alterungsprüfung.

Ebenfalls im CTF-Verfahren führen wir Prüfungen und Zertifizierungen für Kabelverschraubungen durch, welche für den Einsatz in Explosionsgefährdeten Bereichen (Zündschutzart „e“ und „d“) zugelassen sind.

Desweiteren haben wir unser Testlabor um Prüfungen für den E-Mobility-Markt erweitert. In unserem EMV-Testlabor messen wir den Einfluss der Kabelverschraubung auf den Kopplungswiderstand des Kabels, oder wir bestimmen die Strombelastbarkeit von Hochvoltkabel mit Kabelverschraubung.

All dies erlaubt uns bereits in der Entwicklungsphase die Normvorschriften zu überprüfen und in die weitere Entwicklung mit einfließen zu lassen.

Darüber hinaus sind wir in den wichtigsten nationalen und internationalen Normengremien vertreten, damit wir aktiv die zukünftigen Normen mitgestalten können.

Specially built testing facilities

We also have our own specially designed test facilities, which allow us to conduct oil-spray, flexing, pull-out and accelerated aging tests **in accordance with the American UL 514B standard**.

We also carry out CTF testing and certification for cable glands that are approved for use in potentially explosive atmospheres (ignition protection type “e” and “d”).

We have also expanded our test laboratory to include tests for the e-mobility market. In our EMC test laboratory, we can measure the influence of the cable gland on the cable's transfer impedance, for example, or we can determine the current carrying capacity of high-voltage cables with cable glands.

All of this enables us to check with respect to applicable standards already during the initial development phase, and to incorporate their requirements in the subsequent development work.

AGRO is represented in the most important national and international standardisation bodies, enabling us to take an active role in the development of future standards.

Für jede Sonderlösung richtig

The right choice for any special needs



Das AGRO Prüflabor

Unser hauseigenes Prüflabor ist nach CTF-Verfahren durch die Zulassungsstellen zertifiziert und garantiert die Qualität unserer Produkte. Es kann Tests durchführen, deren Resultate durch offizielle Zertifizierungsstellen wie etwa der Eurofins Electrosuisse, dem VDE oder den UL als Basis für die Ausstellung eines Zertifikates anerkannt werden.

The AGRO testing laboratory

Our in-house testing laboratory is certified according to CTF procedures by the accreditation bodies, and ensures the quality of our products. It can carry out tests, the results of which are recognised by official certification bodies such as Eurofins Electrosuisse, VDE or UL as the basis for an official certification.

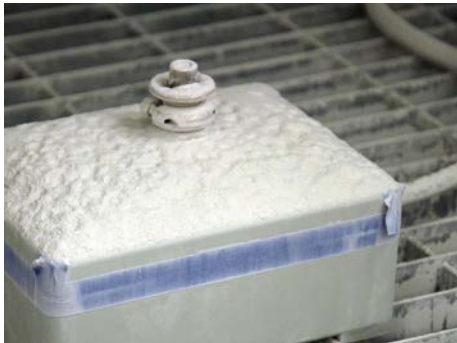

Staubprüfung / Dust test



Schlagprüfung / Impact test

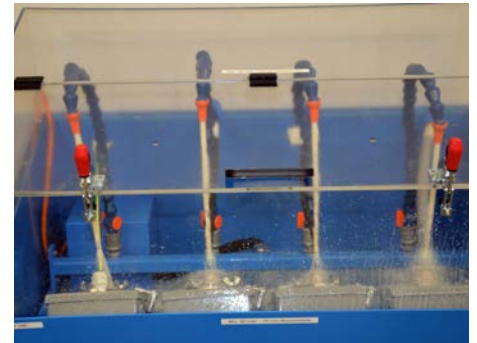

Oil Spray Test / Oil Spray Test

Wir testen Ihre individualisierten Komponenten

Wenn ein Sonderteil normative Vorgaben erfüllen muss, so ist unser Prüflabor in der Lage, deren Einhaltung zu überprüfen - mit Ihrem individuellen Produkt und den effektiv eingesetzten Kabeln. Eine grösstmögliche Gewährleistung der Funktionssicherheit unter spezifischen Bedingungen kann so geboten werden. Unser Prüflabor ist mit zeitgemäßem Equipment ausgerüstet und kann folgende Tests durchführen:

- Wasserdruckfestigkeit
- Spritz- und Strahlwasserbeständigkeit
- Zugkraft
- Glühdrahtfestigkeit
- Querdruck
- Wärmealterung
- Wechselbiegefestigkeit
- Staubprüfung
- Klimatest
- Oil Spray Test
- Schlagprüfung
- Strombelastbarkeit
- Kopplungswiderstand Kabelschirm (EMV)
- etc.

We can test your customised components

If a special part is required to comply with official standards or requirements, our testing laboratory can check its compliance - with your specific product and the cables that are to be used in practice. This ensures the greatest possible assurance of functional reliability under specific conditions. Our testing laboratory is well equipped with up-to-date instruments and can carry out the following tests:

- Water pressure resistance
- Resistance to water splashes and water jets
- Tensile strength
- Glow wire resistance
- Lateral pressure resistance
- Thermal ageing
- Flexural strength
- Dust test
- Climatic test
- Oil spray test
- Impact resistance
- current carrying capacity
- transfer impedance of cable shield (EMC)
- etc.

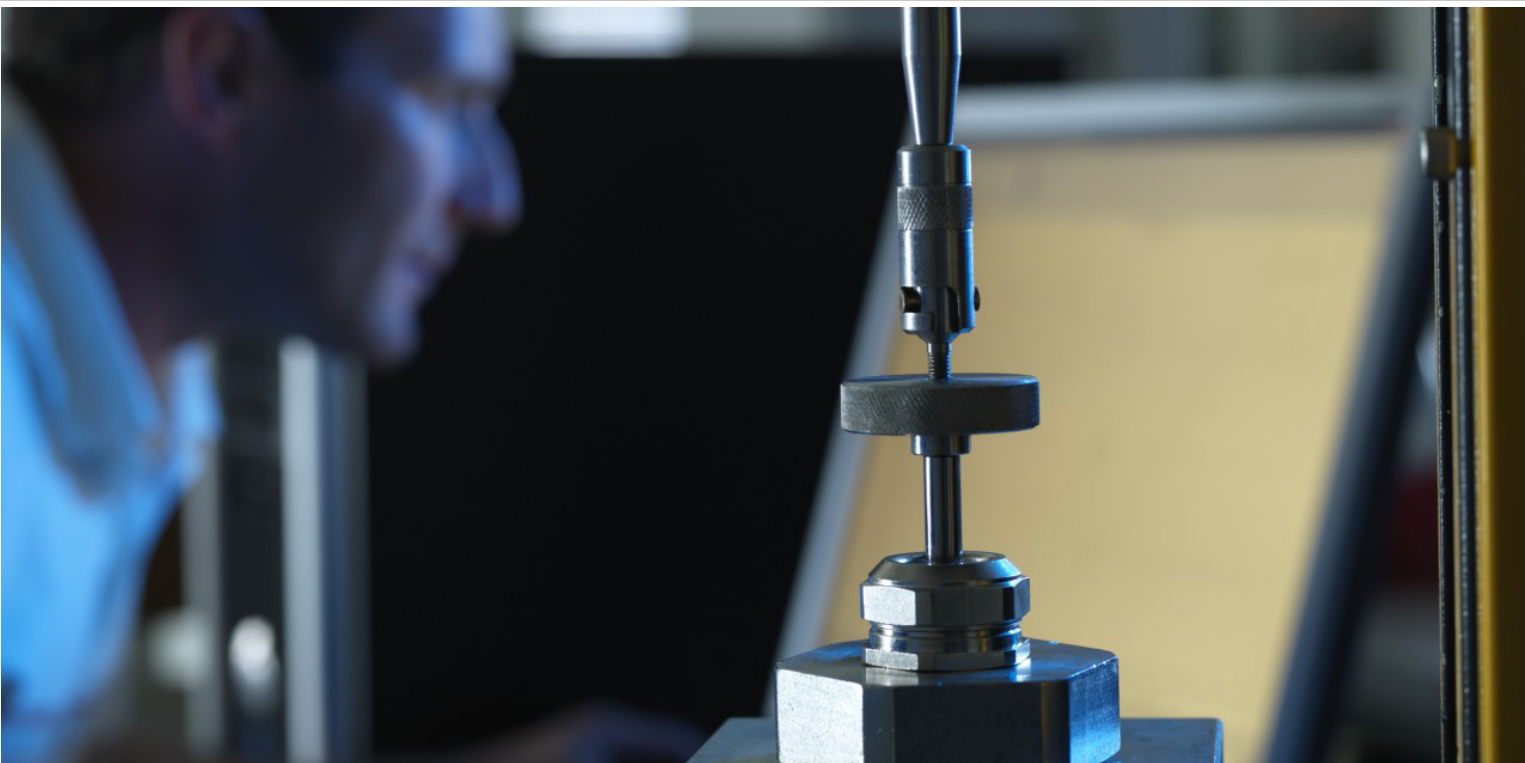

Die Ausgangslage

Für den Wagenübergang bei Zügen wurde eine Sonderlösung ausgearbeitet, bei der grosses Gewicht auf Vibrationssicherheit und schonende Kabelklemmung gelegt wurde. Der Dichteinsatz der Kabelverschraubung musste gemäss Anforderungen der EN 45545 ausgeführt sein.

The situation

A special solution needed to be worked out for the inter-carriage transitions of a particular type of trains, in which great emphasis was placed on vibration resistance and especially protective cable clamping. The sealing insert of the cable gland required to be designed in accordance with EN 45545.



Dichtheitsprüfung / Sealing test



Biegetest / Flexing Test



Zugprüfung / Tensile test

Prüfanordnung

Die Kabelverschraubung mit dem F-Dichteinsatz wurde als erstes mit dem Originalkabel einer Dichtheitsprüfung unterzogen, anschliessend wurde ebenfalls mit dem einzusetzenden Jumperkabel ein Flexingtest mit 500 Zyklen durchgeführt. Nach dieser Belastung wurde eine weitere Dichtheitsprüfung durchgeführt, um zu eruieren, ob - und falls ja - wie stark die Dichtleistung abgenommen hat.

Zu guter Letzt wurde mit der bereits belasteten Kabelverschraubung die maximale Auszugskraft ermittelt.

Nachdem die Kombination Kabelverschraubung-Kabel die Tests erfolgreich bestanden hat, kann der Kunde mit Zuversicht davon ausgehen, dass das ausgearbeitete Sonderteil im realen Einsatz seine Aufgabe langfristig lösen wird.

Test arrangement

A cable gland with an F-type sealing insert was first subjected to a sealing test, using the original cable. Then a 500-cycle flexing test was carried out using the proposed jumper cable. After this loading, a further sealing test was carried out to determine whether - and if so, by how much - the sealing performance had decreased.

Finally, the maximum pull-out force was determined using the already stressed cable gland.

After the cable gland / cable combination had successfully passed the tests, the customer could have confidence that the special part as developed will provide good, reliable long-term performance.

Sonderlösung für very heavy duty Special solution for "very heavy duty" application

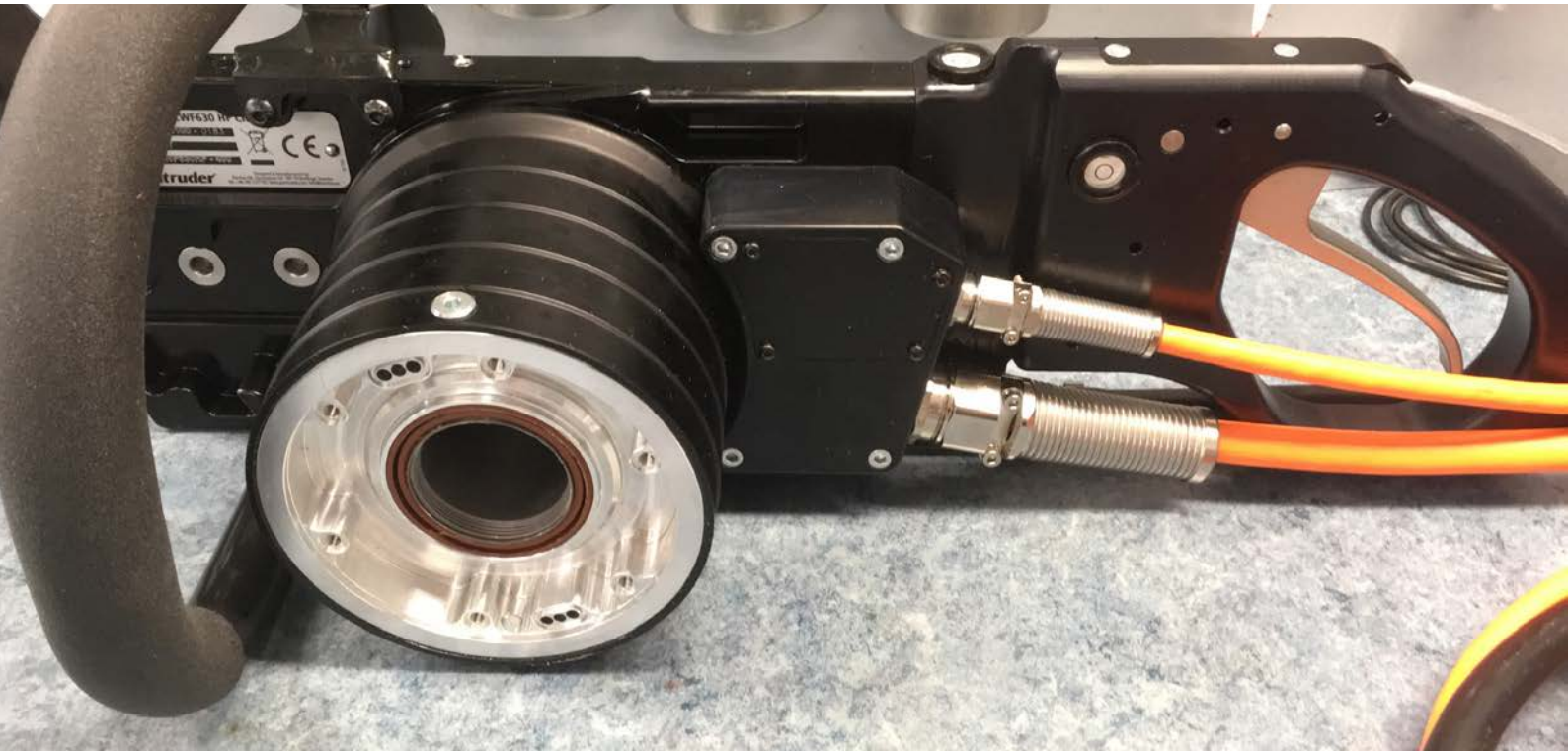

Die Ausgangslage

Betonbearbeitungsmaschinen müssen viel aushalten können. Sowohl Wasser als auch Steinschlag darf ihnen nichts anhaben können. Kabeleintrittsstellen sind besonders gefährdet.

Die Anforderungen

Die Kabel sollten durch einen Knickschutz vor Überbelastung geschützt und im gleichen Zug soll verhindert werden, dass Kabel ausreißen können. Gleichzeitig sollte ein EMV-Abgriff bei der Eintrittsstelle erfolgen.



Progress® mit Knickschutzfeder und Klemmbacken /
Progress® with anti-kink spring and clamps

Die Lösung von AGRO

Die Standard-EMV-Kabelverschraubung mit Knickschutzfeder aus gewendelttem Edelstahl bildet die Basis der Lösung. Sie fängt selbst hohe dynamische Biegebelastungen sicher am Kabeleintritt ab und sorgt dafür, dass das Kabel vor Quetschen und Abknicken geschützt ist. Mit den zusätzlich integrierten Klemmbacken wird eine sehr hohe Zugentlastung erreicht, die verhindert, dass das Kabel ausgerissen wird und gewährleistet, dass die EMV-Schirmkontaktierung trotz dynamischer Belastung sicher bleibt.

The situation

Construction equipment for concrete must be able to withstand a great deal. It should not be damaged by water or stone impacts. Cable entry points are particularly vulnerable.

The requirements

Cables required to be protected against kinking while also being prevented from pulling out of the enclosure. An EMC grip was required at the entry point.



Betonsägemaschine /
Concrete saw

The AGRO solution

The solution is based on the standard EMC cable gland with anti-kink protection from a spiral stainless-steel spring. It safely absorbs even high dynamic bending loads at the cable entry point, and protects the cable against crushing and buckling. With the additionally integrated clamping jaws, a very high degree of strain relief is achieved, which prevents the cable from being pulled out and ensures that the EMC shield contact remains secure despite the dynamic loading.

Montageanleitung für Kabelverschraubungen Progress® Assembly instructions for Progress® cable glands

Das Unterteil der Kabelverschraubung in das entsprechende Gewinde einschrauben.

Oder:

Das Unterteil der Kabelverschraubung in die vorhandene Eintrittsöffnung im Gehäuse einführen und mittels Gegenmutter befestigen.

Wenn bei zweiteiligen Dichteinsätzen der Kabeldurchmesser das obere Ende des Klemmbereiches der Kabelverschraubung erreicht, muss der innere Teil des Dichteinsatzes entfernt werden.

Kabel, Dichteinsatz und Druckmutter in das Unterteil einführen, Druckmutter von Hand leicht verschrauben.

Druckmutter mit passendem Gabelschlüssel anziehen bis der Dichteinsatz zwischen Druckmutter und Kabel einen kleinen Wulst bildet. Bitte benutzen Sie die Tabelle Montage-Drehmoment auf unserer Website www.agro.ch.

Montage nur durch in der Elektrotechnik ausgebildete Installateure! Liegen keine entsprechenden Fachkenntnisse vor, so kann es zu einer unsachgemässen Montage kommen, welche die Sicherheit des Produktnutzers gefährdet.

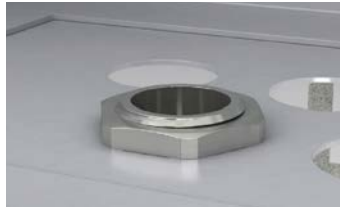

Screw the lower part of the cable gland into the corresponding thread.

Or:

Put the lower part of the cable gland into an existing opening in the enclosure and fix it by means of a lock nut.

Remove the inner part of the two-piece sealing insert if the cable diameter is at the upper end of the clamping range of the cable gland.

Insert the cable, sealing insert and compression nut into the lower part of the cable gland and manually tighten the compression nut.

Tighten the compression nut by means of a spanner until the sealing insert bulges slightly between the compression nut and the cable.

Please refer to the instruction sheet with details of installation torques on our website, www.agro.ch.

Installation only by competent technicians with suitable training in the field of electro-technology! If the installer does not have the required specialist knowledge, this can result in improper installation, jeopardising the safety of the product user.

Progress® EMV easyCONNECT Messing

Kontaktfeder aus dem Unterteil der Kabelverschraubung entfernen.

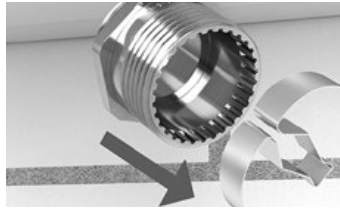

Das Unterteil der Kabelverschraubung in das entsprechende Gewinde einschrauben oder in die vorhandene Eintrittsöffnung im Gehäuse einführen und mittels Gegenmutter befestigen.



Kabel abisolieren.



Kontaktfeder auf den Kabelschirm aufsetzen.

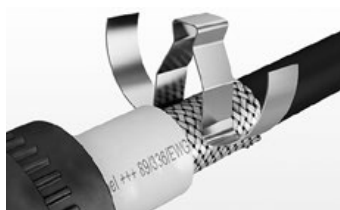

Wenn bei zweiteiligen Dichteinsätzen der Kabeldurchmesser das obere Ende des Klemmbereiches der Kabelverschraubung erreicht, muss der innere Teil des Dichteinsatzes entfernt werden.



Kabel, Kontaktfeder, Dichteinsatz und Druckmutter in das Unterteil einführen, Druckmutter von Hand leicht verschrauben.



Druckmutter mit passendem Gabelschlüssel anziehen bis der Dichteinsatz zwischen Druckmutter und Kabel einen kleinen Wulst bildet.

Bitte benutzen Sie die Tabelle Montage-Drehmoment auf unserer Website www.agro.ch.



Montage nur durch in der Elektrotechnik ausgebildete Installateure! Liegen keine entsprechenden Fachkenntnisse vor, so kann es zu einer unsachgemäßen Montage kommen, welche die Sicherheit des Produktnutzers gefährdet.



Progress® EMC easyCONNECT brass

Remove the contact spring from the lower part of the cable gland.

Screw the lower part of the cable gland into the corresponding thread or put it into an existing opening in the enclosure and fix it by means of a lock nut.

Strip the cable.

Clip the contact spring onto the cable shield.

Remove the inner part of the two-piece sealing insert if the cable diameter is at the upper end of the clamping range of the cable gland.

Insert the cable, contact spring, sealing insert and compression nut into the lower part of the cable gland and manually tighten the compression nut.

Tighten the compression nut by means of a spanner until the sealing insert bulges slightly between the compression nut and the cable.

Please refer to the instruction sheet with details of installation torques on our website, www.agro.ch.

Installation only by competent technicians with suitable training in the field of electro-technology! If the installer does not have the required specialist knowledge, this can result in improper installation, jeopardising the safety of the product user.

Progress® EMV powerCONNECT Messing

Progress® EMC powerCONNECT brass

Kabel vorbereiten, empfohlene Schirmlänge gemäss Tabelle.

M16	13 mm +
M20	14 mm +
M25	15 mm +
M32	17 mm +
M40	18 mm +
M50/63	20 mm +
M75/80/85	22 mm +

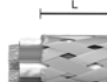

Bauteile auf Kabel aufreihen.
ACHTUNG - Einbau Presshülse.

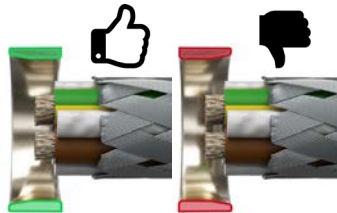

Kabel in Unterteil einführen, Geflecht leicht auffächern und über Konus stülpen.



Presshülse über Geflecht in Konus schieben.



Zwischenstück (mit Dichteinsatz als Zentrierhilfe) aufschrauben und bis auf Block festdrehen.



Druckmutter auf Zwischenstück schieben und mit Werkzeug anziehen bis der Dichteinsatz zwischen Druckmutter und Kabel einen kleinen Wulst bildet.

Bitte benutzen Sie die Tabelle Montage-Drehmoment auf unserer Website www.agro.ch.



Montage nur durch in der Elektrotechnik ausgebildete Installateure! Liegen keine entsprechenden Fachkenntnisse vor, so kann es zu einer unsachgemässen Montage kommen, welche die Sicherheit des Produktnutzers gefährdet.



Prepare cable, consult table for recommended shield length.

Line up components on the cable.
ATTENTION - Orientation of compression ring.

Insert the cable through the cable gland's lower part, loosen the shield braiding to spread it lightly apart, and insert the shield braiding into the recess of the cable gland's lower part, onto its tapered surface.

Push the compression ring into the recess of the cable gland's lower part, clamping the shield braiding onto the tapered surface.

Screw on the intermediate piece (with the sealing insert acting as a centring aid) and tighten it fully.

Place the compression nut onto the intermediate piece and tighten with a spanner until the sealing insert bulges slightly between the compression nut and the cable.

Please refer to the instruction sheet with details of installation torques on our website, www.agro.ch.

Installation only by competent technicians with suitable training in the field of electro-technology! If the installer does not have the required specialist knowledge, this can result in improper installation, jeopardising the safety of the product user.

Progress® EMV RAPID

1 Komplette Kabelverschraubung (5 Teile) in das vorgesehene Gehäuse einschrauben, ohne die Druckmutter fester anzuziehen.

2 Kabelaussenmantel partiell abisolieren oder auf gewünschte Länge zuschneiden.

Hinweis: Zum Schutz des Kabelschirms, kann ein Kupfer-Tape auf den Schirm montiert werden.

3 Kabel in die Kabelverschraubung einführen, bis der Schirm in der Kontaktscheibe (5) einrastet oder der Kabelmantel an der Scheibe ansteht.

4 Druckmutter (1) mit dem Unterteil (4) verschrauben bis der Dichteinsatz zwischen Druckmutter und Kabel einen kleinen Wulst bildet.

Bitte benutzen Sie die Tabelle Montage-Drehmoment auf unserer Website www.agro.ch.

Die Progress® EMV Rapid kann durch Ausstossen der Kontaktscheibe (5) auch ohne Weiterführen des Schirms montiert werden. Weitere Informationen dazu in der Montageanleitung der PROGRESS EMV oder dem Montagevideo auf unserer Webseite www.agro.ch.

Montage nur durch in der Elektrotechnik ausgebildete Installateure! Liegen keine entsprechenden Fachkenntnisse vor, so kann es zu einer unsachgemässen Montage kommen, welche die Sicherheit des Produktnutzers gefährdet.

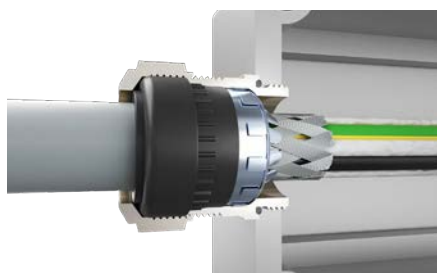
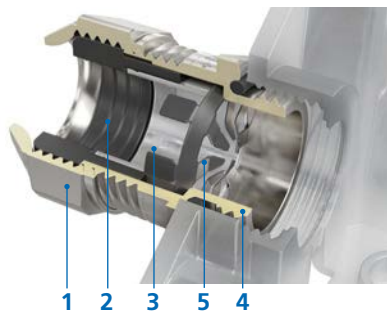

Progress® EMC RAPID

1 Screw in the complete cable gland (5 parts) into the intended housing without further tightening the compression nut.

2 Partially dismantle the outer cable sleeve or trim to the desired length.

Note: To protect the cable shield, a copper tape may be wrapped around the shield.

3 Feed cable into the cable gland until the shielding engages with the contact disc (5) or the cable sheath comes in contact with the disc.

4 Tighten compression nut (1) onto the cable gland's lower part (4) until the sealing insert bulges slightly between the compression nut and the cable.

Please refer to the instruction sheet with details of installation torques on our website, www.agro.ch.

The Progress® EMC Rapid can also be mounted by pushing out the contact disc (5) if the cable shield can be cut at this location.

Further information can be found in the PROGRESS® EMC installation instructions or by viewing the installation video on our website, www.agro.ch.

Installation only by competent technicians with suitable training in the field of electro-technology! If the installer does not have the required specialist knowledge, this can result in improper installation, jeopardising the safety of the product user.

Progress® EMV

- 1 Unterteil (4) der Kabelverschraubung in das vorgesehene Gehäuse einschrauben.
- 2 Druckmutter (1), Dichteinsatz (2) und Kontakthülse (3) über das Kabel ziehen.
- 3 Aussenmantel des Kabels auf die gewünschte Länge zurückschneiden.
- 4 Schirmumflechtung oder Schirmfolie ungefähr auf Kontakthülsenlänge X zuschneiden.
- 5 Kontakthülse, Dichteinsatz und Druckmutter bis Mantelende vorschieben.

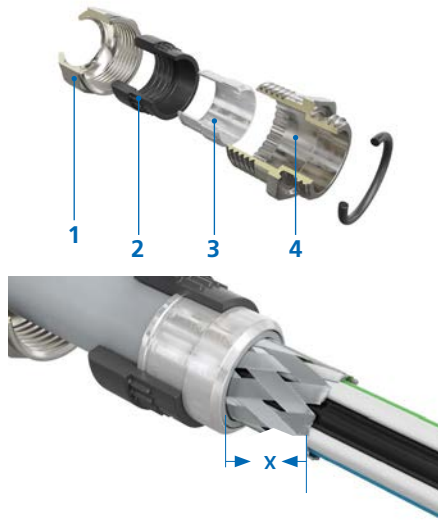

- 6 Schirmgeflecht (6) oder Schirmfolie über Kontakthülse legen und überstehendes Schirmmaterial abschneiden.



- 7 Kabel durch das bereits montierte Unterteil der Kabelverschraubung führen.

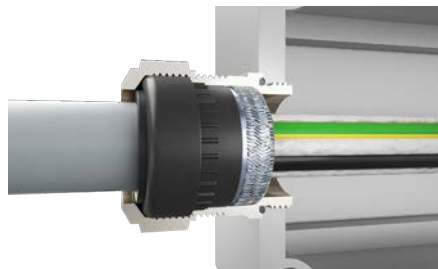

- 8 Dichteinsatz und Kontakthülse bündig in das Unterteil stecken.



- 9 Druckmutter mit dem Unterteil verschrauben, bis der Dichteinsatz zwischen Druckmutter und Kabel einen kleinen Wulst bildet.

Bitte benutzen Sie die Tabelle Montage-Drehmoment auf unserer Website www.agro.ch.



Montage nur durch in der Elektrotechnik ausgebildete Installateure! Liegen keine entsprechenden Fachkenntnisse vor, so kann es zu einer unsachgemässen Montage kommen, welche die Sicherheit des Produktnutzers gefährdet.



- 1 Screw the lower part (4) of the cable gland into the housing.
- 2 Push compression nut (1), sealing insert (2) and contact sleeve (3) over the cable.
- 3 Trim outer sheath of the cable to the desired length.
- 4 Trim shield braiding or shield foil to the approximate length of the contact sleeve, X.
- 5 Push contact sleeve, sealing insert and compression nut to the end of the sheath.

- 6 Turn back the shield braiding (6) or shield foil over the contact sleeve and cut off the protruding shield material.

- 7 Feed cable through the already mounted lower part of the cable gland.

- 8 Insert sealing insert and contact sleeve fully and cleanly into the lower part.

- 9 Tighten compression nut to the lower part until the sealing insert bulges slightly between the compression nut and the cable. Please refer to the instruction sheet with details of installation torques on our website, www.agro.ch.

Installation only by competent technicians with suitable training in the field of electro-technology! If the installer does not have the required specialist knowledge, this can result in improper installation, jeopardising the safety of the product user.

Progress® EMV Serie 85

1 Den Kabelmantel und Kabelschirm mit einer Schere sauber auf die gewünschte Länge zurückschneiden, wenn der Kabelschirm nicht weiter geführt werden muss.

Um den Kabelschirm optimal zu schützen, ist es erforderlich, das der Lieferung beiliegende Kupfer-EMV-Tape (Kupferklebeband 25 mm, Scotch 3M Typ 1181) zu montieren.

2 Das Unterteil (Pos. 5) der Kabelverschraubung in das vorgesehene Gehäuse einschrauben, Druckmutter (Pos. 1), Dichteinsatz (Pos. 2), Zwischenstück (Pos. 4) und Spannzange (Pos. 3) über das Kabel aufschieben. Kabel mit der Spannzange in das Unterteil einführen und positionieren.

3 Zwischenstück mit dem Unterteil verschrauben, bis das Kabel fühlbar geklemmt wird, anschliessend gemäss unten stehender Tabelle festziehen.

4 Druckmutter mit dem Zwischenstück (Zwischenstück mit Schlüssel kontern) verschrauben.

Bitte benutzen Sie die Tabelle Montage-Drehmoment auf unserer Website www.agro.ch.

Montage nur durch in der Elektrotechnik ausgebildete Installateure! Liegen keine entsprechenden Fachkenntnisse vor, so kann es zu einer unsachgemässen Montage kommen, welche die Sicherheit des Produktnutzers gefährdet.

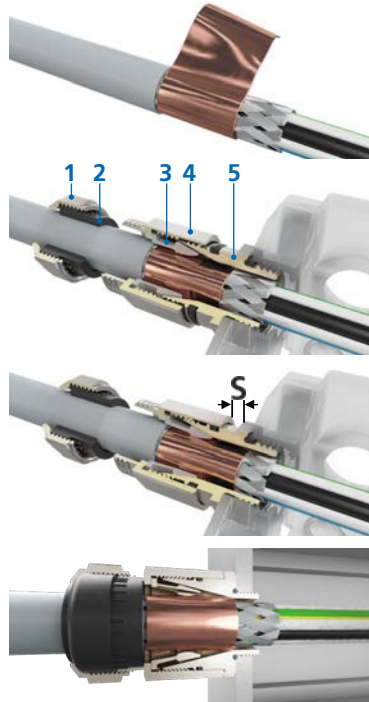

Progress® EMC Series 85

1 Trim the outer cable sheath and cable shield neatly to the desired length using a cutter if the cable shield need not be continued.

To provide the best possible protection for the cable shield, it is necessary to use the supplied copper EMC tape (copper adhesive tape 25 mm wide, Scotch 3M type 1181).

2 Screw the lower part (item 5) of the cable gland into the housing. Push the compression nut (item 1), sealing insert (item 2), intermediate piece (item 4) and collet-grip piece (item 3) over the cable. Insert the cable with the collet-grip piece on it into the cable gland's lower part, and position it.

3 Screw the intermediate piece onto the cable gland's lower part until the cable becomes tangibly clamped, then tighten according to the table below.

4 Screw the compression nut onto the intermediate piece (hold the intermediate piece using a spanner)

Please refer to the instruction sheet with details of installation torques on our website, www.agro.ch.

Installation only by competent technicians with suitable training in the field of electrotechnology! If the installer does not have the required specialist knowledge, this can result in improper installation, jeopardising the safety of the product user.

Das Kupfer-Tape muss zwingend gemäss Illustration montiert werden! Klebeschutzfolie vorgängig entfernen.

The copper tape must be applied as shown in the illustration! Remove protection film first.

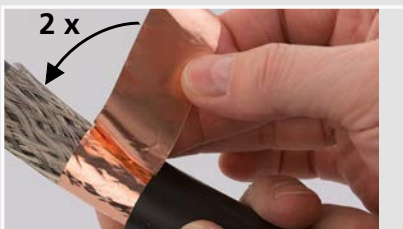

Tape: Scotch 3M Typ 1181
Tape: Scotch 3M Type 1181



Hilfstabelle zur optimalen Schirmkontaktierung

Die Angaben dienen als Arbeitshilfe und ermöglichen eine fachgerechte Montage der Kabelverschraubung Progress EMV Serie 85. Die Richtwerte sind unverbindlich.

Information Table for Optimum Shield Contact

The information is provided as a work aid and facilitates professional installation of the Progress EMC Series 85 cable gland. The reference values are provided for general guidance only and are non-binding.

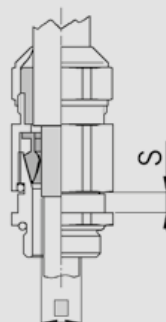

Art-Nr. Art. No.	Ø Schirm Ø Shield	S mm
1000.17.85.045	3.0 - 4.0	0
	4.0 - 4.5	1.0
1000.17.85.080	4.5 - 6.0	0
	6.0 - 8.0	1.5
1000.17.85.100	7.5 - 10.0	0
	7.5 - 10.0	0
1000.20.85.120	10.0 - 12.0	1.5
1000.20.85.140	10.0 - 12.0	0
	12.0 - 14.0	1.5
1000.25.85.160	10.0 - 13.0	0
	13.0 - 16.0	2.0
1000.25.85.190	14.0 - 16.5	0
	16.5 - 19.0	2.0
1000.32.85.220	14.0 - 18.0	0
	18.0 - 22.0	3.0
1000.32.85.250	21.0 - 23.0	0
	23.0 - 25.0	2.0
1000.40.85.300	21.0 - 25.5	0
	25.5 - 30.0	3.0
1000.50.85.380	29.0 - 33.5	0
	33.5 - 38.0	3.0
1000.63.85.380	29.0 - 33.5	0
	33.5 - 38.0	3.0
1000.63.85.440	35.0 - 39.5	0.5
	39.5 - 44.0	3.0

Masse für Gewinde und Bohrlöcher

Dimensions of threads and holes

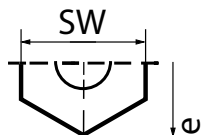



Ermittlung der Eckmasse „e“

6-Kant:
 $e = 1.155 \times SW$ (Schlüsselweite)

Determination of the width across corners "e"

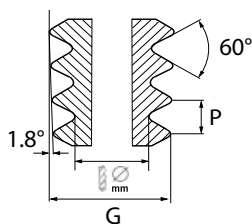
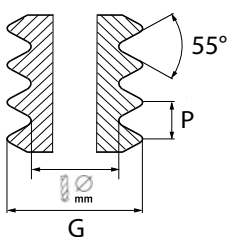
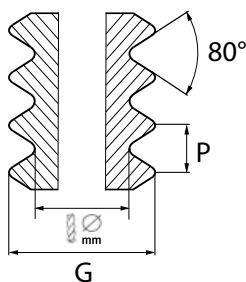
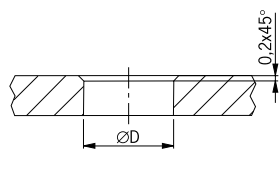
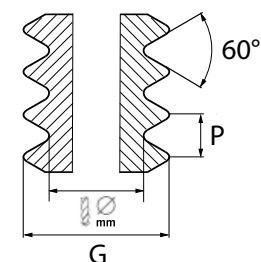
hexagon:
 $e = 1.155 \times SW$ (spanner size / width across flats)



	G	Steigung Pitch P	 mm	ØD mm
Metrisches Gewinde Metric thread				
M6x1.0 ¹⁾	6.00	1.00	5.00	6.0
M6x0.75 ²⁾	6.00	0.75	5.25	6.0
M8x1.25 ¹⁾	8.00	1.25	6.75	8.0
M8x1.0 ²⁾	8.00	1.00	7.00	8.0
M10x1.5 ¹⁾	10.00	1.50	8.50	10.0
M10x1.0 ²⁾	10.00	1.00	9.00	10.0
M12x1.5	12.00	1.50	10.50	12.0
M16x1.5	16.00	1.50	14.50	16.0
M20x1.5	20.00	1.50	18.50	20.0
M25x1.5	25.00	1.50	23.50	25.0
M32x1.5	32.00	1.50	30.50	32.0
M40x1.5	40.00	1.50	38.50	40.2
M50x1.5	50.00	1.50	48.50	50.2
M63x1.5	63.00	1.50	61.50	63.2
M75x1.5	75.00	1.50	73.50	75.2
M80x1.5	80.00	1.50	78.50	80.2
M85x2.0	85.00	2.00	83.00	85.2
M95x2.0	95.00	2.00	93.00	95.2
M100x3.0	100.00	3.00	97.00	100.2
M105x3.0	105.00	3.00	102.00	105.2
M115x3.0	115.00	3.00	112.00	115.2
Pg Gewinde Pg thread				
Pg 7	12.50	1.27	11.40	12.6
Pg 9	15.20	1.41	14.00	15.3
Pg 11	18.60	1.41	17.25	18.7
Pg 13	20.40	1.41	19.00	20.5
Pg 16	22.50	1.41	21.25	22.6
Pg 21	28.30	1.58	26.75	28.4
Pg 29	37.00	1.58	35.50	37.2
Pg 36	47.00	1.58	45.50	47.2
Pg 42	54.00	1.58	52.50	54.2
Pg 48	59.30	1.58	57.80	59.5
Gasrohr-Gewinde Gas-pipe thread				
G 1/4"	13.15	1.33	11.60	13.3
G 3/8"	16.66	1.33	15.00	16.8
G 1/2"	20.95	1.81	19.00	21.0
G 5/8"	22.91	1.81	21.00	23.0
G 3/4"	26.44	1.81	24.60	26.5
G 1"	33.25	2.30	30.50	33.5
G 1 1/4"	41.91	2.30	39.50	42.2
G 1 1/2"	47.80	2.30	45.00	48.0
G 2"	59.61	2.30	57.00	60.0
G 2 1/2"	75.18	2.30	72.50	75.5
G 3"	87.88	2.30	84.50	88.0
G 4"	113.03	2.30	110.50	113.5
G 5"	138.43	2.30	136.00	139.0
NPT Gewinde NPT thread				
NPT 1/8"	10.29	0.94	8.43	
NPT 1/7"	13.72	1.41	11.13	
NPT 3/8"	17.14	1.41	14.27	
NPT 1/2"	21.34	1.81	17.86	
NPT 3/4"	26.67	1.81	23.28	
NPT 1"	33.40	2.20	28.98	
NPT 1 1/4"	42.16	2.20	37.69	
NPT 1 1/2"	48.26	2.20	43.66	
NPT 2"	60.32	2.20	55.58	

Unsere Gegenmuttern passen in jedem Fall auf unsere entsprechenden Gewinde der Kabelverschraubung, auch wenn sie nicht immer in eine Gewindelehre passen.

- 1) Metrisches Regelgewinde
- 2) Metrisches Gewinde nach EN60423

Our lock nuts always suit the threads of our corresponding cable glands, even if they do not always match a thread gauge.



- 1) Standard metric thread
- 2) Metric thread acc. to EN 60423

1. Ziffer:

Schutzgrad für Berührungs- und Fremdkörperschutz

1st figure:

Degree of protection against access to hazardous parts and the ingress of solid foreign objects

Definitionen Definitions	
IP 0x	Kein Schutz No protection
IP 1x 	Schutz gegen Eindringen von festen Fremdkörpern grösser als 50 mm (unbeabsichtigtes Berühren mit der Hand) Protection against penetration by solid foreign objects larger than 50 mm (accidental touching by hand)
IP 2x 	Schutz gegen Eindringen von festen Fremdkörpern grösser als 12 mm (unbeabsichtigtes Berühren mit den Fingern) Protection against penetration by solid foreign objects larger than 12 mm (accidental touching with fingers)
IP 3x 	Schutz gegen Eindringen von festen Fremdkörpern grösser als 2.5 mm (unbeabsichtigtes Berühren mit Werkzeugen, Drähten usw., dicker als 2.5mm) Protection against penetration by solid foreign objects larger than 2.5 mm (accidental touching with tools, wires etc. larger than 2.5 mm)
IP 4x 	Schutz gegen Eindringen von festen Fremdkörpern grösser als 1 mm (Berühren mit Werkzeugen, Drähten usw., dicker als 1 mm) Protection against penetration by solid foreign objects larger than 1 mm (touching with tools, wires etc. larger than 1 mm)
IP 5x 	Vollständiger Schutz gegen Berühren, Schutz gegen schädliche Staubablagerung – Eindringen von Staub wird nicht vollkommen verhindert Complete protection from being touched. Protection from harmful dust deposits - dust penetration is not completely prevented
IP 6x 	Vollständiger Schutz gegen Berühren, Schutz gegen Eindringen von Staub Complete protection from being touched. Protection against penetration by dust.









Genauere Erläuterungen finden sich in den aktuellen Normen.
More detailed explanations can be found in the current standards.

2. Ziffer:

Schutzgrad für Wasserschutz

2nd figure:

Liquid ingress protection

Definitionen Definitions	
IP x0	Kein Schutz No protection
IP x1 	Senkrecht fallende Tropfen dürfen keine schädigende Wirkung haben Dripping water (vertically falling drops) shall have no harmful effect
IP x2 	Senkrecht fallende Tropfen dürfen keine schädigende Wirkung haben, wenn das Gehäuse um einen Winkel von bis zu 15° beiderseits der Senkrechten geneigt ist Vertically dripping water shall have no harmful effect when the enclosure is tilted at an angle up to 15° from its upright position
IP x3 	Sprühwasser, das in einem Winkel bis zu 60° beiderseits der Senkrechten gesprüht wird, darf keine schädliche Wirkung haben Water spray sprayed at any angle of up to 60° from the vertical shall have no harmful effect
IP x4 	Spritzwasser, das aus jeder Richtung gegen das Gehäuse spritzt, darf keine schädliche Wirkung haben Splash water splashing against the enclosure from any direction shall have no harmful effect
IP x5 	Strahlwasser, das aus jeder Richtung als Strahl gegen das Gehäuse gerichtet ist, darf keine schädliche Wirkung haben Water jets directed against the enclosure from any direction shall have no harmful effects
IP x6 	Starkes Strahlwasser, das aus jeder Richtung als starker Strahl gegen das Gehäuse spritzt, darf keine schädliche Wirkung haben Strong jets of water projected in powerful jets against the enclosure from any direction shall have no harmful effects
IP x7 	Wasser darf nicht in einer Menge eintreten, die schädliche Wirkungen verursacht, wenn das Gehäuse unter genormten Druck- und Zeitbedingungen zeitweilig in Wasser getaucht ist Ingress of water in harmful quantity shall not be possible when the enclosure is immersed in water under defined conditions of pressure and time
IP x8 	Wasser darf nicht in einer Menge eintreten, die schädliche Wirkungen verursacht, wenn das Gehäuse dauernd unter Wasser getaucht ist unter Bedingungen, die zwischen Hersteller und Anwender vereinbart werden müssen; die Bedingungen müssen jedoch schwieriger sein als für Kennziffer 7 Water must not enter in a quantity causing harmful effects when the enclosure is continuously submerged in water under conditions to be agreed between the manufacturer and the user; however, the conditions must be more demanding than for code number 7
IP x9	Schutz gegen Eindringen von Wasser unter Hochdruck (80-100 bar) mit einer Temperatur bis 80°C (z. B. Dampfstrahlreinigung) Protection against ingress of water under high pressure (80-100 bar) with a temperature of up to 80°C (e. g. steam jet cleaning)

Materialübersichtstabelle – Metalle

Materials overview – Metals

Produkt Product	Messing vernickelt Nickel-plated brass	Messing bleifrei Lead-free brass	Stahl A2 Stainless steel A2	Stahl A4 Stainless steel A4	Aluminium Aluminium	Aluminium Aluminium
Materialbezeichnung Material designation	CuZn39Pb3	CuZn21Si3P CW724R	X8CrNiS 10 9 DIN 1.4305/ AISI 303	X2CrNiMo 18 14 3 DIN 1.4435/AISI 316 L	AlMgSi0.5 DIN 3.3206	AlMg4,5Mn0.7 DIN 3.3547
Bezeichnung Designation	Kupfer/Zinklegierung Oberfläche galvanisch vernickelt Copper/zinc alloy Surface galvanically nickel-plated	Si-haltiges, bleifreies Sondermessing Oberfläche galvanisch vernickelt Si-containing, lead-free special brass Surface galvanically nickel-plated	Rostbeständiger Stahl Stainless steel	Rost- und säurebeständiger Stahl Acid-resistant stainless steel	Aluminium Aluminium	Aluminium Aluminium
Korrosionsverhalten Chem. Beständigkeit	Gut beständig in trockener Atmosphäre, Süßwasser, Wasserdampf, Mineralölen, Kraftstoffen, Kühl-/Schmierstoffen und vielen organischen Emulsionen	Gut beständig in normaler trockener Atmosphäre, gegen Süßwasser, Mineralöle, Kraftstoffe, Kühl- und Schneidflüssigkeiten, in Meeres- und Industrielatmosphäre, gegen neutrale und alkalische Salzlösungen sowie organische Verbindungen	Gut beständig gegen verdünnte organische und oxidierende Säuren, Laugen, neutrale und alkalische Salzlösungen sowie organische Verbindungen	Gute Beständigkeit gegen organische Säuren, z.B. Zitronen-, Milch-, Ameisen-, Wein- und Essigsäure, bei hoher Konzentration und Temperatur. Anorganische Säuren, z.B. Bor-Phosphor- und Salpetersäure sowie schweflige Säure, bei mässiger Konzentration und Temperatur	Gut beständig in trockener Atmosphäre, Mineralölen, Kraftstoffen	Sehr gute Korrosionsbeständigkeit in Süß-, Brack- und Meerwasser sowie in trockener Atmosphäre
Corrodibility Chemical resistance	High resistance in dry atmosphere, freshwater, water vapour, mineral oils, motor fuels, coolants/lubricants and many other organic emulsions	Good resistance in a normal, dry atmosphere, against fresh water, mineral oils, fuels, cooling and cutting fluids, in marine and industrial atmospheres, against neutral and alkaline saline solutions and organic compounds	High resistance against diluted organic and oxidizing acids, bases, neutral and alkaline saline solutions, as well as against organic compounds	Good resistance against organic acids such as citric, lactic, formic, tartaric and acetic acids, in high concentrations and at high temperatures. Good resistance against inorganic acids such as boric, phosphoric, nitric and sulphurous acids, at moderate concentrations and temperatures	Good resistance in dry atmosphere, mineral oils, motor fuels	Very good corrosion resistance in freshwater, brackwater, seawater and dry atmosphere
Bedingt bzw. nicht beständig	Meer-, Brackwasser, feuchte Atmosphären, Säuren, Laugen, Chloride, Ammoniak	Unbeständig gegen Säuren, Halogene, Chloride und chloridhaltige Lösungen in Atmosphären mit hoher Feuchte und erhöhten Temperaturen	Anorganische Säuren, Halogene, Chloride und chloridhaltige Lösungen oder Atmosphären	Salzsäure, Halogene, Chloride und chloridhaltige Lösungen oder Atmosphären	Süß-, Meer-, Brackwasser, feuchte Atmosphären, Säuren, Laugen	Bedingt beständig gegen Säuren und Laugen
Non-resistant or only partially resistant	Seawater, brackwater, humid atmospheres, acids, alkaline solutions, chlorides, ammonia	Not resistant to acids, halogens, chlorides and chloride-containing solutions in atmospheres with high humidity and elevated temperatures	Inorganic acids, halogens, chlorides and chloride-containing solutions or atmospheres	Hydrochloric acid, halogens, chlorides and chloride-containing solutions or atmospheres	Freshwater, seawater, brackwater, humid atmospheres, acids, alkaline solutions	Partial resistance to acids and alkaline solutions
Witterungsbeständigkeit	Sehr gute Witterungs- und Alterungsbeständigkeit	Sehr gute Witterungs- und Alterungsbeständigkeit	Sehr gute Witterungs- und Alterungsbeständigkeit	Sehr gute Witterungs- und Alterungsbeständigkeit	Gute Witterungs- und Alterungsbeständigkeit	Sehr gute Witterungsbeständigkeit
Resistance to weathering	Very good resistance to weathering and ageing	Very good resistance to weathering and ageing	Very good resistance to weathering and ageing	Very good resistance to weathering and ageing	Good resistance to weathering and ageing	Very good resistance to weathering
Thermische Werte dauernd Permanent thermal conditions	-60°C / +200°C	-60°C / +200°C	-60°C / +200°C	-60°C / +200°C	-60°C / +200°C	-30°C / +105°C
Brennbarkeit Combustibility	Nicht brennbar Non-combustible	Nicht brennbar Non-combustible	Nicht brennbar Non-combustible	Nicht brennbar Non-combustible	Nicht brennbar Non-combustible	Nicht brennbar Non-combustible

Bei speziellen Anwendungen bitten wir um Ihre schriftliche Anfrage.

In case of special applications, we kindly ask you to send us your written request.

Materialübersichtstabelle – Kunststoffe

Materials overview – Elastomeric materials

Produkt Product	Agromid	PA GFK PA GFK (GRP)	PA	Polyester
Bezeichnung Designation	Polyamid PA6 GF30, glasfaserverstärkt, schlagzäh, wärmestabi- lisiert	Polyamid PA6 GF30, glasfaserverstärkt	Polyamid PA6	Polyester PET
Farbe Colour	Nach Katalog See catalogue	Nach Katalog See catalogue	Nach Katalog See catalogue	Nach Katalog See catalogue
Chem. Beständigkeit Chemical resistance	Beständig gegen verdünnte organische Säuren, Laugen, wässrige Lösungen von anorganischen Salzen, Mineralöle, Kraftstoffe, Kühl- und Schneideöle			Gute Beständigkeit gegen Wasser (bei Raumtemperatur), verdünnte Säuren, neutrale und saure Salze, Alkohol, Ether, Öle, Fette, perchlorierte und aromatische Kohlenwasserstoffe
	Resistant against diluted organic acids, alkaline solutions, aqueous inorganic saline solutions, mineral oils, motor fuels, cooling and cutting oils			Good resistance to water (room temperature), diluted acids, neutral and acid salts, alcohol, ethers, oils, greases, perchlorinated and aromatic hydrocarbons
Bedingt bzw. nicht beständig Non-resistant or only partially resistant	Mineralsäuren, konzentrierte organische Säuren, Ameisensäure, Phenole, Halogene			Alkalien, überhitzten Dampf, Ketone, Phenole, Ester, oxidierende Säuren und Kohlenwasserstoffe, Ammoniak
	Mineral acids, concentrated organic acids, formic acids, phenols, halogens			Alkalis, superheated steam, ketones, phenols, esters, oxidising acids and hydrocarbons, ammonia
Witterungsbeständigkeit Resistance to weathering	Gute Witterungs- und Alterungsbeständigkeit	Gute Witterungsbeständigkeit	Gute Witterungsbeständigkeit, in schwarz UV-beständig (getestet nach EN ISO 4892-2)	Gute Witterungsbeständigkeit
	Good resistance to weathering and ageing	Good resistance to weathering	Good weather resistance, in black UV-resistant (tested according to EN ISO 4892-2)	Good resistance to weathering
Thermische Werte dauernd Permanent thermal conditions	-30°C / +100°C	-20°C / +100°C	-30°C / +100°C	-50°C / +150°C
Brennbarkeit Combustibility	Vergleichbar UL 94 HB Halogenfrei Comparable UL 94 HB Halogen-free	Vergleichbar UL 94 HB Halogenfrei Comparable UL 94 HB Halogen-free	UL 94 V-2 Halogenfrei UL 94 V-2 Halogen-free	EN 45545-2 (R22/R23) HL3 Halogenfrei EN 45545-2 (R22/R23) HL3 Halogen-free

Bei speziellen Anwendungen bitten wir um Ihre schriftliche Anfrage.

In case of special applications, we kindly ask you to send us your written enquiry.

Materialübersichtstabelle – Elastomere

Materials overview – Elastomeric materials

Produkt Product	TPE	Spezial AGRO TPE Special AGRO TPE	NBR	FPM
Bezeichnung	Thermoplastisches Elastomer	Thermoplastisches Elastomer, Spezial Compound	Acrylnitril-Butadien-Kautschuk	Fluor-Kautschuk
Designation	Thermoplastic elastomers	Thermoplastic elastomers, special compound	Acrylonitrile-butadiene rubber	Fluorine-rubber
Farbe Colour	Schwarz Black	Hellgrau RAL 7035 Light grey RAL 7035	Schwarz Black	Grün Green
Chem. Beständigkeit	Beständig gegen verdünnte Säuren und Laugen, wässrige Lösungen von anorganischen Salzen	Gut beständig gegen verdünnte Säuren und Laugen, wässrige Lösungen von anorganischen Salzen, Heisswasser sowie Meerwasser	Beständig gegen verdünnte Säuren und Laugen, wässrige Lösungen von anorganischen Salzen, Mineralöle, Kraftstoffe, Kühl- und Schneidöle	Beständig gegen die meisten Säuren und Laugen, wässrige Lösungen von anorganischen Salzen, Mineralöle, Kraftstoffe, Kühl- und Schneidöle
Chemical resistance	Resistant against diluted acids and alkaline solutions and against aqueous solutions of inorganic salts	High resistance against diluted acids and alkaline solutions, aqueous solutions of inorganic salts, hot water and seawater	Resistant against diluted acids and alkaline solutions, aqueous solutions of inorganic salts, mineral oils, motor fuels, cooling and cutting oils	Resistant against most acids and alkaline solutions, aqueous solutions of inorganic salts, mineral oils, motor fuels, cooling and cutting oils
Bedingt bzw. nicht beständig	Konzentrierte Säuren und Laugen, Lösungsmittel, Kraftstoffe, Mineral-, Kühl- und Schneidöle	Nicht beständig gegen konzentrierte Säuren und Laugen, Lösungsmittel und Kraftstoffe	Konzentrierte Säuren und Laugen, Lösungsmittel, Ozon	Konzentrierte Laugen
Non-resistant or only partially resistant	Concentrated acids and alkaline solutions, solvents, motor fuels, mineral, cooling and cutting oils	Not resistant to concentrated acids and alkaline solutions, solvents and motor fuels	Concentrated acids and alkaline solutions, solvents, ozone	Concentrated alkaline solutions
Witterungsbeständigkeit	Gute Witterungs-, Ozon- und Alterungsbeständigkeit	Gute Witterungs-, Ozon- und Alterungsbeständigkeit	Gute Witterungsbeständigkeit	Sehr gute Witterungs-, Ozon- und Alterungsbeständigkeit
Resistance to weathering	Good resistance to weathering, ozone and ageing	Good resistance to weathering, ozone and ageing	Good resistance to weathering	Very good resistance to weathering, ozone and ageing
Thermische Werte dauernd	-40°C / + 100°C	-50°C / +105°C	-40°C / +100°C	-40°C / +200°C
Permanent thermal conditions	- 60°C (Ex)		-60°C (Ex)	
Brennbarkeit	UL 94 HB halogenfrei	EN 45545-2 / HL3 (R22/R23) EN 45545-3 / E30 halogenfrei	vergleichbar UL 94 HB halogenfrei	vergleichbar UL 94 V-2
Combustibility	UL 94 HB Halogen-free	EN 45545-2 / HL3 (R22/R23) EN 45545-3 / E30 Halogen-free	comparable UL 94 HB Halogen-free	comparable UL 94 V-2

Bei speziellen Anwendungen bitten wir um Ihre schriftliche Anfrage.
In case of special applications, we kindly ask you to send us your written enquiry.

Materialübersichtstabelle – Elastomere

Materials overview – Elastomeric materials

Produkt Product	FPM / FKM	EPDM	CR
Bezeichnung Designation	Fluor-Kautschuk Fluorine rubber	Ethylen-Propylen-Terpolymere- Kautschuk ethylene propylene diene monomer rubber	Chloropren-Kautschuk Chloroprene rubber
Farbe Colour	Blau Blue	Nach Katalog See catalogue	Schwarz Black
Chem. Beständigkeit Chemical resistance	Beständig gegen die meisten Säuren und Laugen, wässrige Lösungen von anorganischen Salzen, Mineralöle, Kraftstoffe, Kühl- und Schneidöle FDA konform Resistant against most acids and alkaline solutions, aqueous solutions of inorganic salts, mineral oils, motor fuels, cooling and cutting oils In conformity with FDA requirements.	Heisswasser, wässrige Lösungen von anorganischen Salzen, verdünnte Säuren und Laugen Hot water, aqueous solutions of inorganic salts, diluted acids and alkaline solutions	Beständig gegen verdünnte Säuren und Laugen, wässrige Lösungen von anorganischen Salzen, Mineral-, Kühl- und Schneidöle Resistant against diluted acids and alkaline solutions, aqueous solutions of inorganic salts, mineral oils, cooling oils and cutting oils
Bedingt bzw. nicht beständig Non-resistant or only partially resistant	Konzentrierte Laugen Concentrated alkaline solutions	Mineralöle, Kraft- und Treibstoffe, konzentrierte Säuren und Laugen, Ester Mineral oils, motor fuels and propellants, concentrated acids and alkaline solutions, esters	Konzentrierte Säuren und Laugen, Lösungsmittel, Kraftstoffe, Heisswasser, Ozon Concentrated acids and alkaline solutions, solvents, motor fuels, hot water, ozone
Witterungsbeständigkeit Resistance to weathering	Sehr gute Witterungs-, Ozon- und Alterungsbeständigkeit Very good resistance to weathering, ozone and ageing	Gute Witterungs-, Ozon- und Alterungsbeständigkeit Good resistance to weathering, ozone and ageing	Gute Witterungsbeständigkeit Good resistance to weathering
Thermische Werte dauernd Permanent thermal conditions	-40°C / +200°C	-40°C / +80°C (KTW W270) -40°C / +100°C -40°C / +110°C	-30°C / +100°C
Brennbarkeit Combustibility	Vergleichbar UL94 V-2 Comparable UL 94 V-2 Halogen-free	Vergleichbar UL 94 HB halogenfrei Comparable UL 94 HB Halogen-free	Vergleichbar UL 94 HB Comparable UL 94 HB

Bei speziellen Anwendungen bitten wir um Ihre schriftliche Anfrage.

In case of special applications, we kindly ask you to send us your written enquiry.

Vergleich rostfreier und säurebeständiger Stahl A4

Comparison of stainless and acid-resistant steel A4



Edelstahl rostfrei ist der Sammelbegriff für nichtrostende Stähle, die sich durch besondere Beständigkeit gegen chemisch angreifende Stoffe auszeichnen. Sie haben einen Massenanteil von 10,5 % Chrom (Cr) und von höchstens 1,2 % Kohlenstoff (C). Ein höherer Chromgehalt und der Zusatz weiterer Legierungselemente wie Nickel (Ni), Molybdän (Mo), Mangan (Mn) und Kupfer (Cu) verbessern die Korrosionsstabilität, verändern aber auch die mechanischen Eigenschaften.

Wir vergleichen hier die beiden rostfreien und säurebeständigen Stähle DIN EN 1.4404 und DIN EN 1.4435. Beide sind eine beliebte Wahl für Kabelverschraubungen mit hohen Ansprüchen an die Korrosionsbeständigkeit.

Der von AGRO AG verwendete Stahl A4 mit der Werkstoffnummer DIN EN 1.4435 (AISI 316L) ist eine höher legierte Variante des DIN EN 1.4404. Er weist in natürlichen Umweltmedien wie Salzwasser, ländlichen und städtischen Atmosphären, in Industriegebieten mit gemässigten Chlor- und Salzkonzentrationen sowie im Bereich der Nahrungsmittelproduktion eine ausgezeichnete Korrosionsbeständigkeit auf. Aufgrund des höheren Chrom-, Nickel- und Molybdän-Anteils ist der DIN EN 1.4435 im Vergleich zu anderen A4 Stählen in der Säurebeständigkeit unübertroffen. Der massgebende Molybdän-Anteil verbessert besonders die Beständigkeit gegen Chlorid, Schwefelsäure und organische Säuren.

Stainless steel is a general term for non-rusting steels that are characterised by particularly good resistance against chemically aggressive substances. They contain minimum 10.5% chromium (Cr) by weight, and maximum 1.2% carbon (C). A higher chromium content and the addition of further alloying elements such as nickel (Ni), molybdenum (Mo), manganese (Mn) and copper (Cu) improve corrosion resistance, but also change the material's mechanical properties.

Here, we compare two rust- and acid-proof steels: DIN EN 1.4404 and DIN EN 1.4435. Both are widely used for cable glands with high demands in relation to corrosion resistance.

The A4 steel used by AGRO AG, with the material number DIN EN 1.4435 (AISI 316L), is a more highly alloyed variation of type DIN EN 1.4404. It exhibits excellent corrosion resistance in natural environmental media such as saltwater, in rural and urban atmospheres, in industrial areas with moderate concentrations of chlorine and salt, and in the field of food production. Due to its higher chromium, nickel and molybdenum contents, type DIN EN 1.4435 is unsurpassed by other A4 steels in terms of resistance to acids. The significant presence of molybdenum particularly improves the resistance to chlorides, sulphuric acid and organic acids.

Technische Daten

Technical details

Stahl Steel	C (%)	Cr (%)	Ni (%)	Mo (%)	Mn (%)	Cu (%)	Si (%)	P (%)	S (%)
DIN 1.4435 (AGRO) (AISI 316L)	≤ 0.03	17.0 - 19.0	12.5 - 15.0	2.5 - 3.5	≤ 2.0	0.11	≤ 1.0	≤ 0.045	≤ 0.015
DIN 1.4404 (AISI 316L)	≤ 0.03	16.5 - 18.5	10.0 - 13.0	2.0 - 2.5	≤ 2.0	0	≤ 1.0	≤ 0.045	≤ 0.015

Anwendungsgebiete

Der Werkstoff DIN EN 1.4435 kann sehr gut in chemischen Anlagen, für medizinischen Anwendungen, in der pharmazeutischen Industrie, der Lebensmittelherstellung sowie der Vakuumtechnik eingesetzt werden. Dank seiner aussergewöhnlichen Korrosionsbeständigkeit ist dieser Stahl auch optimal für die Schwimmbadtechnik und in Kläranlagen geeignet.

Application areas

The material DIN EN 1.4435 finds good application in chemical facilities, for medical uses, in the pharmaceutical industry, in food production and in vacuum technology. Thanks to its exceptional corrosion resistance, this type of steel is also ideally suited to use in swimming pool technology and in wastewater treatment or water purification plants.

Art.-No. Art.-No.	Seite Page	Art.-No. Art.-No.	Seite Page	Art.-No. Art.-No.	Seite Page
10...		1000.11.055	23	1000.17.080	17
1000.06.025	17	1000.11.085	23	1000.17.080LF	190
1000.06.030	17	1000.11.120	23	1000.17.105	17
1000.06.035	17	1000.11.20.30	38	1000.17.105LF	190
1000.06.30	38	1000.11.20.30.91	39	1000.17.30	38
1000.06.30.03	276	1000.11.30	38	1000.17.30.03	276
1000.06.30.91	39	1000.11.30.03	276	1000.17.30.91	39
1000.06.91.025	34	1000.11.30.91	39	1000.17.85.045	105
1000.06.91.030	34	1000.11.85.080	106	1000.17.85.080	105
1000.06.91.035	34	1000.11.85.120	106	1000.17.85.100	105
1000.06.98.30.03	277	1000.11.91.120	36	1000.17.91.105	34
1000.07.050	23	1000.11.92	36	1000.17.92	34
1000.07.065	23	1000.11.98.30.03	277	1000.17.98.30.03	277
1000.07.080	23	1000.11/2G	29	1000.17LF	190
1000.07.30	38	1000.11/2NPT	28	1000.1G	29
1000.07.30.91	39	1000.11/2NPT.330	28	1000.1NPT	28
1000.07.91.050	36	1000.11/2NPT.370	28	1000.1NPT.170	28
1000.07.91.065	36	1000.11/2NPT.410	28	1000.1NPT.210	28
1000.07.91.080	36	1000.11/4NPT	28	1000.1NPT.255	28
1000.08.035	17	1000.11/4NPT.240	28	1000.20	18
1000.08.050	17	1000.11/4NPT.285	28	1000.20.080	17
1000.08.30	38	1000.11/4NPT.330	28	1000.20.080LF	190
1000.08.30.03	276	1000.115.30.03	276	1000.20.110	17
1000.08.30.91	39	1000.115.950	17	1000.20.110LF	190
1000.08.91.035	34	1000.12.050	17	1000.20.150	17
1000.08.91.050	34	1000.12.050LF	190	1000.20.150LF	190
1000.08.98.30.03	277	1000.12.065	17	1000.20.30	38
1000.085.30.03	276	1000.12.065LF	190	1000.20.30.03	276
1000.09	24	1000.12.080	17	1000.20.30.91	39
1000.09.00.08	278	1000.12.080LF	190	1000.20.85.120	105
1000.09.045	23	1000.12.30	38	1000.20.85.140	105
1000.09.060	23	1000.12.30.03	276	1000.20.91.150	34
1000.09.080	23	1000.12.30.91	39	1000.20.92	34
1000.09.105	23	1000.12.91.050	34	1000.20.98.30.03	277
1000.09.30	38	1000.12.91.065	34	1000.20LF	190
1000.09.30.91	39	1000.12.91.080	34	1000.21	24
1000.09.91.105	36	1000.12.98.30.03	277	1000.21.125	23
1000.09.92	36	1000.13	24	1000.21.160	23
1000.095.30.03	276	1000.13.080	23	1000.21.205	23
1000.1/2G	29	1000.13.110	23	1000.21.30	38
1000.1/2NPT	28	1000.13.150	23	1000.21.30.91	39
1000.1/2NPT.080	28	1000.13.30	38	1000.21.32.30	38
1000.1/2NPT.110	28	1000.13.30.91	39	1000.21.32.30.91	39
1000.1/2NPT.150	28	1000.13.91.150	36	1000.21.85.160	106
1000.1/4NPT.050	28	1000.13.92	36	1000.21.85.190	106
1000.1/4NPT.065	28	1000.16	24	1000.21.91.205	36
1000.1/4NPT.080	28	1000.16.080	23	1000.21.92	36
1000.1/8NPT.040	28	1000.16.110	23	1000.21/2G.500	29
1000.1/8NPT.060	28	1000.16.150	23	1000.21/2G.560	29
1000.10.040	17	1000.16.25.30	38	1000.25	18
1000.10.060	17	1000.16.25.30.91	39	1000.25.125	17
1000.10.30	38	1000.16.30	38	1000.25.125LF	190
1000.10.30.03	276	1000.16.30.91	39	1000.25.160	17
1000.10.30.91	39	1000.16.85.120	106	1000.25.160LF	190
1000.10.91.040	34	1000.16.85.150	106	1000.25.205	17
1000.10.91.060	34	1000.16.91.150	36	1000.25.205LF	190
1000.10.98.30.03	277	1000.16.92	36	1000.25.30	38
1000.100.30.03	276	1000.17	18	1000.25.30.03	276
1000.100.850	17	1000.17.045	17	1000.25.30.91	39
1000.105.30.03	276	1000.17.045LF	190	1000.25.85.160	105
1000.105.900	17	1000.17.060	17	1000.25.85.190	105
1000.11	24	1000.17.060LF	190	1000.25.91.205	34

Art.-No. Art.-No.	Seite Page	Art.-No. Art.-No.	Seite Page	Art.-No. Art.-No.	Seite Page
1000.25.92	34	1000.3G.700	29	1000.63.520	17
1000.25.98.30.03	277	1000.40	18	1000.63.520LF	190
1000.25LF	190	1000.40.00.08	278	1000.63.85.380	105
1000.29	24	1000.40.240	17	1000.63.85.440	105
1000.29.190	23	1000.40.240LF	190	1000.63.91.520	34
1000.29.230	23	1000.40.285	17	1000.63.92	34
1000.29.275	23	1000.40.285LF	190	1000.63.98.30.03	277
1000.29.30	38	1000.40.30	38	1000.63LF	190
1000.29.30.03	276	1000.40.30.03	276	1000.75	18
1000.29.30.91	39	1000.40.30.91	39	1000.75.00.08	278
1000.29.40.30	38	1000.40.330	17	1000.75.30.03	276
1000.29.40.30.91	39	1000.40.330LF	190	1000.75.500	17
1000.29.85.220	106	1000.40.85.300	105	1000.75.560	17
1000.29.85.250	106	1000.40.91.330	34	1000.75.630	17
1000.29.91.275	36	1000.40.92	34	1000.85.700	17
1000.29.92	36	1000.40.98.30.03	277	1000.95.750	17
1000.29.98.30.03	277	1000.40LF	190	1000.95.800	17
1000.2G	29	1000.42	24	1005.00.08	278
1000.2NPT	28	1000.42.00.08	278	1006.00.08	278
1000.2NPT.400	28	1000.42.30	38	1006.00.16	280
1000.2NPT.460	28	1000.42.30.91	39	1006.06.08	278
1000.2NPT.520	28	1000.42.330	23	1007.00.08	278
1000.3/4G	29	1000.42.370	23	1007.00.16	280
1000.3/4NPT	28	1000.42.420	23	1007.45.16	281
1000.3/4NPT.125	28	1000.42.91.420	36	1007.52	45
1000.3/4NPT.160	28	1000.42.92	36	1007.80.10	108
1000.3/4NPT.205	28	1000.48	24	1008.00.16	280
1000.3/8G	29	1000.48.00.08	278	1008.52	45
1000.3/8NPT	28	1000.48.30	38	1009.00.16	280
1000.3/8NPT.045	28	1000.48.30.03	276	1009.45.16	281
1000.3/8NPT.060	28	1000.48.30.91	39	1009.52	45
1000.3/8NPT.080	28	1000.48.370	23	1010.00.16	280
1000.3/8NPT.105	28	1000.48.430	23	1010.52	45
1000.32	18	1000.48.490	23	1011.00.08	278
1000.32.170	17	1000.48.91.490	36	1011.00.16	280
1000.32.170LF	190	1000.48.92	36	1011.00.19	282
1000.32.210	17	1000.48.98.30.03	277	1011.45.16	281
1000.32.210LF	190	1000.50	18	1011.52	45
1000.32.255	17	1000.50.00.08	278	1011.80.10	108
1000.32.255LF	190	1000.50.30	38	1012.00.16	280
1000.32.30	38	1000.50.30.03	276	1012.00.19	282
1000.32.30.03	276	1000.50.30.91	39	1012.45.16	281
1000.32.30.91	39	1000.50.330	17	1012.52	45
1000.32.85.220	105	1000.50.330LF	190	1013.00.16	280
1000.32.85.250	105	1000.50.370	17	1013.00.22.08	278
1000.32.91.255	34	1000.50.370LF	190	1013.45.16	281
1000.32.92	34	1000.50.420	17	1013.51	45
1000.32.98.30.03	277	1000.50.420LF	190	1013.52	45
1000.32LF	190	1000.50.85.380	105	1016.00.08	278
1000.36	24	1000.50.91.420	34	1016.00.16	280
1000.36.260	23	1000.50.92	34	1016.00.25.08	278
1000.36.30	38	1000.50.98.30.03	277	1016.45.16	281
1000.36.30.03	276	1000.50LF	190	1016.51	45
1000.36.30.91	39	1000.63	18	1016.52	45
1000.36.305	23	1000.63.00.08	278	1016.80.10	108
1000.36.350	23	1000.63.30	38	1017.00.16	280
1000.36.50.30	38	1000.63.30.03	276	1017.00.19	282
1000.36.50.30.91	39	1000.63.30.91	39	1017.45.16	281
1000.36.91.350	36	1000.63.400	17	1017.52	45
1000.36.92	36	1000.63.400LF	190	1017.80.10	108
1000.36.98.30.03	277	1000.63.460	17	1020.00.19	282
1000.3G.630	29	1000.63.460LF	190	1020.45.16	281

Art.-No. Art.-No.	Seite Page	Art.-No. Art.-No.	Seite Page	Art.-No. Art.-No.	Seite Page
1020.51	45	1045.25.110	224	1060.16.080	22
1020.52	45	1045.25.170	224	1060.16.110	22
1020.80.10	108	1045.32.150	224	1060.16.145	22
1021.00.16	280	1045.32.210	224	1060.16.52	47
1021.00.30.08	278	1045.40.230	224	1060.16.52.080	47
1021.45.16	281	1045.40.280	224	1060.16.52.110	47
1021.51	45	1045.50.290	224	1060.16.52.145	47
1021.80.10	108	1045.50.350	224	1060.17	16
1025.00.16	280	1045.63.390	224	1060.17.060	16
1025.00.19	282	1045.63.480	224	1060.17.080	16
1025.45.16	281	1048.00.16	280	1060.17.105	16
1025.52	45	1050.00.16	280	1060.17.52	46
1025.80.10	108	1050.00.19	282	1060.17.52.060	46
1029.00.08	278	1050.45.16	281	1060.17.52.080	46
1029.00.16	280	1050.80.10	108	1060.17.52.105	46
1029.00.19	282	1060.06.025	16	1060.20	16
1029.45.16	281	1060.06.030	16	1060.20.080	16
1029.80.10	108	1060.07.050	22	1060.20.110	16
1032.00.16	280	1060.07.065	22	1060.20.145	16
1032.00.19	282	1060.07.075	22	1060.20.52	46
1032.45.16	281	1060.07.52.050	47	1060.20.52.080	46
1032.80.10	108	1060.07.52.065	47	1060.20.52.110	46
1036.00.08	278	1060.07.52.075	47	1060.20.52.145	46
1036.00.16	280	1060.08.030	16	1060.21	22
1036.00.19	282	1060.08.040	16	1060.21.125	22
1036.45.16	281	1060.08.52.030	46	1060.21.160	22
1036.80.10	108	1060.08.52.040	46	1060.21.190	22
1040.00.16	280	1060.09	22	1060.21.52	47
1040.00.19	282	1060.09.060	22	1060.21.52.125	47
1040.17.40.065	72	1060.09.080	22	1060.21.52.160	47
1040.17.40.080	72	1060.09.105	22	1060.21.52.190	47
1040.17.96.30.065	73	1060.09.52	47	1060.25	16
1040.17.96.30.080	73	1060.09.52.060	47	1060.25.125	16
1040.17.96.70.065	73	1060.09.52.080	47	1060.25.160	16
1040.17.96.70.080	73	1060.09.52.105	47	1060.25.190	16
1040.20.40.080	72	1060.10.040	16	1060.25.52	46
1040.20.40.105	72	1060.10.060	16	1060.25.52.125	46
1040.20.96.30.080	73	1060.10.52.040	46	1060.25.52.160	46
1040.20.96.30.105	73	1060.10.52.060	46	1060.25.52.190	46
1040.20.96.70.080	73	1060.11	22	1060.29	22
1040.20.96.70.105	73	1060.11.055	22	1060.29.230	22
1040.25.40.110	72	1060.11.085	22	1060.29.275	22
1040.25.40.150	72	1060.11.120	22	1060.32	16
1040.25.96.30.110	73	1060.11.52	47	1060.32.210	16
1040.25.96.30.150	73	1060.11.52.060	47	1060.32.255	16
1040.25.96.70.110	73	1060.11.52.080	47	1060.32.52	46
1040.25.96.70.150	73	1060.11.52.105	47	1060.32.52.210	46
1040.32.40.160	72	1060.12.050	16	1060.32.52.245	46
1040.32.40.205	72	1060.12.065	16	1060.36	22
1040.32.96.30.160	73	1060.12.075	16	1060.36.305	22
1040.32.96.30.205	73	1060.12.52.050	46	1060.36.350	22
1040.32.96.70.160	73	1060.12.52.065	46	1060.40	16
1040.32.96.70.205	73	1060.12.52.075	46	1060.40.285	16
1040.45.16	281	1060.13	22	1060.40.330	16
1040.80.10	108	1060.13.080	22	1060.42	22
1042.00.16	280	1060.13.110	22	1060.42.370	22
1045.12.050	224	1060.13.145	22	1060.42.420	22
1045.12.070	224	1060.13.52	47	1060.48	22
1045.17.060	224	1060.13.52.080	47	1060.48.430	22
1045.17.100	224	1060.13.52.110	47	1060.48.490	22
1045.20.080	224	1060.13.52.145	47	1060.50	16
1045.20.130	224	1060.16	22	1060.50.370	16

Art.-No. Art.-No.	Seite Page	Art.-No. Art.-No.	Seite Page	Art.-No. Art.-No.	Seite Page
1060.50.420	16	1080.17.52.100	102	1081.09.100	95
1060.63	16	1080.17.91.080	100	1081.11.085	95
1060.63.460	16	1080.17.91.100	100	1081.11.120	95
1060.63.520	16	1080.20.110	96	1081.12.060	94
1060.75	16	1080.20.110LF	193	1081.12.075	94
1060.75.560	16	1080.20.140	96	1081.13.110	95
1060.75.630	16	1080.20.140LF	193	1081.13.140	95
1063.00.16	280	1080.20.52.110	102	1081.16.110	95
1063.00.19	282	1080.20.52.140	102	1081.16.140	95
1063.45.16	281	1080.20.91.110	100	1081.17.080	94
1063.80.10	108	1080.20.91.140	100	1081.17.100	94
1080.07.060	98	1080.21.160	98	1081.20.110	94
1080.07.075	98	1080.21.190	98	1081.20.140	94
1080.07.52.060	103	1080.21.52.160	103	1081.21.160	95
1080.07.52.075	103	1080.21.52.190	103	1081.21.190	95
1080.08.035	96	1080.21.91.160	101	1081.25.160	94
1080.08.040	96	1080.21.91.190	101	1081.25.190	94
1080.08.52.035	102	1080.25.160	96	1081.29.230	95
1080.08.52.040	102	1080.25.160LF	193	1081.29.255	95
1080.09.080	98	1080.25.190	96	1081.32.210	94
1080.09.100	98	1080.25.190LF	193	1081.32.250	94
1080.09.52.080	103	1080.25.52.160	102	1083.12.050	93
1080.09.52.100	103	1080.25.52.190	102	1083.12.050LF	192
1080.09.91.080	101	1080.25.91.160	100	1083.12.065	93
1080.09.91.100	101	1080.25.91.190	100	1083.12.065LF	192
1080.10.040	96	1080.29.230	98	1083.17	93
1080.10.060	96	1080.29.255	98	1083.17LF	192
1080.10.52.040	102	1080.29.91.230	101	1083.20	93
1080.10.52.060	102	1080.29.91.255	101	1083.20LF	192
1080.10.91.040	100	1080.32.210	96	1083.25	93
1080.10.91.060	100	1080.32.210LF	193	1083.25LF	192
1080.11.085	98	1080.32.250	96	1083.32	93
1080.11.120	98	1080.32.250LF	193	1083.32LF	192
1080.11.52.080	103	1080.32.52.210	102	1083.40	93
1080.11.52.100	103	1080.32.52.245	102	1083.40LF	192
1080.11.91.085	101	1080.32.91.210	100	1083.50	93
1080.11.91.120	101	1080.32.91.250	100	1083.50LF	192
1080.12.060	96	1080.36.305	98	1083.63	93
1080.12.060LF	193	1080.36.350	98	1083.63LF	192
1080.12.075	96	1080.40.285	96	1084.17	104
1080.12.075LF	193	1080.40.285LF	193	1084.20	104
1080.12.52.060	102	1080.40.320	96	1084.25	104
1080.12.52.075	102	1080.40.320LF	193	1084.32	104
1080.12.91.060	100	1080.42.370	98	1084.40	104
1080.12.91.075	100	1080.42.410	98	1084.50	104
1080.13.110	98	1080.48.430	98	1084.63	104
1080.13.140	98	1080.48.465	98	1084.75	104
1080.13.52.110	103	1080.50.370	96	1084.80.650	104
1080.13.52.140	103	1080.50.370LF	193	1084.85.700	104
1080.13.91.110	101	1080.50.410	96	1089.098.05	114
1080.13.91.140	101	1080.50.410LF	193	1089.103.05	114
1080.16.110	98	1080.63.460	96	1089.114.05	114
1080.16.140	98	1080.63.460LF	193	1089.132.05	114
1080.16.52.110	103	1080.63.500	96	1089.146.05	114
1080.16.52.140	103	1080.63.500LF	193	1089.154.05	114
1080.16.91.110	101	1080.75.560	96	1089.160.05	114
1080.16.91.140	101	1080.80.650	96	1089.175.05	114
1080.17.080	96	1080.85.700	96	1089.184.05	114
1080.17.080LF	193	1080.95.750	96	1089.20.01LF	112
1080.17.100	96	1081.07.060	95	1089.20.02LF	113
1080.17.100LF	193	1081.07.075	95	1089.20.098.04	114
1080.17.52.080	102	1081.09.080	95	1089.20.103.04	114

Art.-No. Art.-No.	Seite Page	Art.-No. Art.-No.	Seite Page	Art.-No. Art.-No.	Seite Page
1089.20.114.04	114	1100.07.98.050	65	1100.12.96.050	62
1089.20.132.04	114	1100.07.98.065	65	1100.12.96.065	62
1089.20.146.04	114	1100.07.98.080	65	1100.12.96.080	62
1089.20.20	113	1100.08.035	20	1100.12.98.050	64
1089.20.97.098.03	112	1100.08.050	20	1100.12.98.065	64
1089.20.97.103.03	112	1100.08.91.035	35	1100.12.98.080	64
1089.20.97.114.03	112	1100.08.91.050	35	1100.13	27
1089.20.97.132.03	112	1100.08.94.035	60	1100.13.080	26
1089.20.97.146.03	112	1100.08.94.050	60	1100.13.110	26
1089.200.05	114	1100.08.96.035	62	1100.13.150	26
1089.210.05	114	1100.08.96.050	62	1100.13.50	43
1089.227.05	114	1100.08.98.035	64	1100.13.91.150	37
1089.231.05	114	1100.08.98.050	64	1100.13.92	37
1089.25.01LF	112	1100.09	27	1100.13.94	61
1089.25.02LF	113	1100.09.045	26	1100.13.94.150	61
1089.25.132.04	114	1100.09.060	26	1100.13.96	63
1089.25.146.04	114	1100.09.080	26	1100.13.96.150	63
1089.25.154.04	114	1100.09.105	26	1100.13.98	65
1089.25.160.04	114	1100.09.91.105	37	1100.13.98.150	65
1089.25.175.04	114	1100.09.92	37	1100.16	27
1089.25.184.04	114	1100.09.94	61	1100.16.080	26
1089.25.25	113	1100.09.94.105	61	1100.16.110	26
1089.25.97.132.03	112	1100.09.96	63	1100.16.150	26
1089.25.97.146.03	112	1100.09.96.105	63	1100.16.50	43
1089.25.97.154.03	112	1100.09.98	65	1100.16.91.150	37
1089.25.97.160.03	112	1100.09.98.08	279	1100.16.92	37
1089.25.97.175.03	112	1100.09.98.105	65	1100.16.94	61
1089.25.97.184.03	112	1100.10.040	20	1100.16.94.150	61
1089.32.01LF	112	1100.10.060	20	1100.16.96	63
1089.32.02LF	113	1100.10.91.040	35	1100.16.96.150	63
1089.32.175.04	114	1100.10.91.060	35	1100.16.98	65
1089.32.184.04	114	1100.10.94.040	60	1100.16.98.150	65
1089.32.200.04	114	1100.10.94.060	60	1100.17	21
1089.32.210.04	114	1100.10.96.040	62	1100.17.045	20
1089.32.227.04	114	1100.10.96.060	62	1100.17.045LF	191
1089.32.231.04	114	1100.10.98.040	64	1100.17.060	20
1089.32.32	113	1100.10.98.060	64	1100.17.060LF	191
1089.32.97.175.03	112	1100.11	27	1100.17.080	20
1089.32.97.184.03	112	1100.11.055	26	1100.17.080LF	191
1089.32.97.200.03	112	1100.11.085	26	1100.17.105	20
1089.32.97.210.03	112	1100.11.120	26	1100.17.105LF	191
1089.32.97.227.03	112	1100.11.50	43	1100.17.50	43
1089.32.97.231.03	112	1100.11.91.120	37	1100.17.51	43
11...		1100.11.92	37	1100.17.91.105	35
1100.06.025	20	1100.11.94	61	1100.17.92	35
1100.06.030	20	1100.11.94.120	61	1100.17.94	60
1100.06.035	20	1100.11.96	63	1100.17.94.105	60
1100.06.91.025	35	1100.11.96.120	63	1100.17.96	62
1100.06.91.030	35	1100.11.98	65	1100.17.96.105	62
1100.06.91.035	35	1100.11.98.120	65	1100.17.98	64
1100.07.050	26	1100.12.050	20	1100.17.98.105	64
1100.07.065	26	1100.12.050LF	191	1100.17LF	191
1100.07.080	26	1100.12.065	20	1100.20	21
1100.07.91.050	37	1100.12.065LF	191	1100.20.080	20
1100.07.91.065	37	1100.12.080	20	1100.20.080LF	191
1100.07.91.080	37	1100.12.080LF	191	1100.20.110	20
1100.07.94.050	61	1100.12.91.050	35	1100.20.110LF	191
1100.07.94.065	61	1100.12.91.065	35	1100.20.150	20
1100.07.94.080	61	1100.12.91.080	35	1100.20.150LF	191
1100.07.96.050	63	1100.12.94.050	60	1100.20.50	43
1100.07.96.065	63	1100.12.94.065	60	1100.20.51	43
1100.07.96.080	63	1100.12.94.080	60	1100.20.91.150	35

Art.-No. Art.-No.	Seite Page	Art.-No. Art.-No.	Seite Page	Art.-No. Art.-No.	Seite Page
1100.20.92	35	1100.32.92	35	1100.50	21
1100.20.94	60	1100.32.94	60	1100.50.330	20
1100.20.94.150	60	1100.32.94.255	60	1100.50.330LF	191
1100.20.96	62	1100.32.96	62	1100.50.370	20
1100.20.96.150	62	1100.32.96.255	62	1100.50.370LF	191
1100.20.98	64	1100.32.98	64	1100.50.420	20
1100.20.98.150	64	1100.32.98.255	64	1100.50.420LF	191
1100.20LF	191	1100.32LF	191	1100.50.91.420	35
1100.21	27	1100.36	27	1100.50.92	35
1100.21.125	26	1100.36.260	26	1100.50.94	60
1100.21.160	26	1100.36.305	26	1100.50.94.420	60
1100.21.205	26	1100.36.350	26	1100.50.96	62
1100.21.50	43	1100.36.91.350	37	1100.50.96.420	62
1100.21.91.205	37	1100.36.92	37	1100.50.98	64
1100.21.92	37	1100.36.94	61	1100.50.98.08	279
1100.21.94	61	1100.36.94.350	61	1100.50.98.420	64
1100.21.94.205	61	1100.36.96	63	1100.50LF	191
1100.21.96	63	1100.36.96.350	63	1100.63	21
1100.21.96.205	63	1100.36.98	65	1100.63.400	20
1100.21.98	65	1100.36.98.350	65	1100.63.400LF	191
1100.21.98.205	65	1100.40	21	1100.63.460	20
1100.25	21	1100.40.240	20	1100.63.460LF	191
1100.25.125	20	1100.40.240LF	191	1100.63.520	20
1100.25.125LF	191	1100.40.285	20	1100.63.520LF	191
1100.25.160	20	1100.40.285LF	191	1100.63.91.520	35
1100.25.160LF	191	1100.40.330	20	1100.63.92	35
1100.25.205	20	1100.40.330LF	191	1100.63.94	60
1100.25.205LF	191	1100.40.50	43	1100.63.94.520	60
1100.25.50	43	1100.40.91.330	35	1100.63.96	62
1100.25.51	43	1100.40.92	35	1100.63.96.520	62
1100.25.91.205	35	1100.40.94	60	1100.63.98	64
1100.25.92	35	1100.40.94.330	60	1100.63.98.08	279
1100.25.94	60	1100.40.96	62	1100.63.98.520	64
1100.25.94.205	60	1100.40.96.330	62	1100.63LF	191
1100.25.96	62	1100.40.98	64	1100.75	21
1100.25.96.205	62	1100.40.98.08	279	1100.75.500	20
1100.25.98	64	1100.40.98.330	64	1100.75.560	20
1100.25.98.205	64	1100.40LF	191	1100.75.630	20
1100.25LF	191	1100.42	27	1100.75.98.08	279
1100.29	27	1100.42.330	26	1105.98.08	279
1100.29.190	26	1100.42.370	26	1106.06.98.08	279
1100.29.230	26	1100.42.420	26	1106.98.08	279
1100.29.275	26	1100.42.91.420	37	1107.98.08	279
1100.29.50	43	1100.42.92	37	1111.98.08	279
1100.29.91.275	37	1100.42.94	61	1113.98.22.08	279
1100.29.92	37	1100.42.94.420	61	1116.98.08	279
1100.29.94	61	1100.42.96	63	1116.98.25.08	279
1100.29.94.275	61	1100.42.96.420	63	1121.98.30.08	279
1100.29.96	63	1100.42.98	65	1129.98.08	279
1100.29.96.275	63	1100.42.98.420	65	1136.98.08	279
1100.29.98	65	1100.48	27	1145.12.050	224
1100.29.98.275	65	1100.48.370	26	1145.12.070	224
1100.32	21	1100.48.430	26	1145.17.060	224
1100.32.170	20	1100.48.490	26	1145.17.100	224
1100.32.170LF	191	1100.48.91.490	37	1145.20.080	224
1100.32.210	20	1100.48.92	37	1145.20.130	224
1100.32.210LF	191	1100.48.94	61	1145.25.110	224
1100.32.255	20	1100.48.94.490	61	1145.25.170	224
1100.32.255LF	191	1100.48.96	63	1145.32.150	224
1100.32.50	43	1100.48.96.490	63	1145.32.210	224
1100.32.51	43	1100.48.98	65	1145.40.230	224
1100.32.91.255	35	1100.48.98.490	65	1145.40.280	224

Art.-No. Art.-No.	Seite Page	Art.-No. Art.-No.	Seite Page	Art.-No. Art.-No.	Seite Page
1145.50.290	224	1165.32	201	1180.11.91.085	101
1145.50.350	224	1165.36	202	1180.11.91.120	101
1145.63.390	224	1165.40	201	1180.12.060	97
1145.63.480	224	1165.48	202	1180.12.060LF	194
1145.63.550	224	1165.50	201	1180.12.075	97
1160.06.025	19	1165.63	201	1180.12.075LF	194
1160.06.030	19	1165.80.07.060	207	1180.12.91.060	100
1160.07.065	25	1165.80.07.075	207	1180.12.91.075	100
1160.07.075	25	1165.80.09.080	207	1180.13.110	99
1160.08.030	19	1165.80.09.100	207	1180.13.140	99
1160.08.040	19	1165.80.10.040	206	1180.13.91.110	101
1160.09	25	1165.80.10.060	206	1180.13.91.140	101
1160.09.105	25	1165.80.11.085	207	1180.16.110	99
1160.10.040	19	1165.80.11.120	207	1180.16.140	99
1160.10.060	19	1165.80.12.060	206	1180.16.91.110	101
1160.11	25	1165.80.12.075	206	1180.16.91.140	101
1160.11.120	25	1165.80.13.110	207	1180.17.080	97
1160.12.050	19	1165.80.13.140	207	1180.17.080LF	194
1160.12.065	19	1165.80.16.110	207	1180.17.100	97
1160.12.075	19	1165.80.16.140	207	1180.17.100LF	194
1160.13	25	1165.80.17.080	206	1180.17.91.080	100
1160.13.145	25	1165.80.17.100	206	1180.17.91.100	100
1160.16	25	1165.80.20.110	206	1180.20.110	97
1160.16.145	25	1165.80.20.140	206	1180.20.110LF	194
1160.17	19	1165.80.21.160	207	1180.20.140	97
1160.17.105	19	1165.80.21.190	207	1180.20.140LF	194
1160.20	19	1165.80.25.160	206	1180.20.91.110	100
1160.20.145	19	1165.80.25.190	206	1180.20.91.140	100
1160.21	25	1165.80.29.230	207	1180.21.160	99
1160.21.190	25	1165.80.29.255	207	1180.21.190	99
1160.25	19	1165.80.32.210	206	1180.21.91.160	101
1160.25.190	19	1165.80.32.250	206	1180.21.91.190	101
1160.29	25	1165.80.36.305	207	1180.25.160	97
1160.29.275	25	1165.80.36.350	207	1180.25.160LF	194
1160.32	19	1165.80.40.285	206	1180.25.190	97
1160.32.255	19	1165.80.40.320	206	1180.25.190LF	194
1160.36	25	1165.80.48.430	207	1180.25.91.160	100
1160.36.350	25	1165.80.48.465	207	1180.25.91.190	100
1160.40	19	1165.80.50.370	206	1180.29.230	99
1160.40.330	19	1165.80.50.410	206	1180.29.255	99
1160.42	25	1165.80.63.460	206	1180.29.91.230	101
1160.42.420	25	1165.80.63.500	206	1180.29.91.255	101
1160.48	25	1165.84.20.15	208	1180.32.210	97
1160.48.490	25	1165.84.25.21	208	1180.32.210LF	194
1160.50	19	1165.84.32.34	208	1180.32.250	97
1160.50.420	19	1165.84.40.34	208	1180.32.250LF	194
1160.63	19	1165.84.50.42	208	1180.32.91.210	100
1160.63.520	19	1165.84.63.54	208	1180.32.91.250	100
1160.75	19	1180.07.060	99	1180.36.305	99
1160.75.630	19	1180.07.075	99	1180.36.350	99
1165.07	202	1180.08.035	97	1180.40.285	97
1165.09	202	1180.08.040	97	1180.40.285LF	194
1165.10	201	1180.09.080	99	1180.40.320	97
1165.11	202	1180.09.100	99	1180.40.320LF	194
1165.12	201	1180.09.91.080	101	1180.42.370	99
1165.13	202	1180.09.91.100	101	1180.42.410	99
1165.16	202	1180.10.040	97	1180.48.430	99
1165.17	201	1180.10.060	97	1180.48.465	99
1165.20	201	1180.10.91.040	100	1180.50.370	97
1165.21	202	1180.10.91.060	100	1180.50.370LF	194
1165.25	201	1180.11.085	99	1180.50.410	97
1165.29	202	1180.11.120	99	1180.50.410LF	194

Art.-No. Art.-No.	Seite Page	Art.-No. Art.-No.	Seite Page	Art.-No. Art.-No.	Seite Page
1180.63.460	97	1300.13.150.050	42	1301.40.320.090	41
1180.63.460LF	194	1300.16.130.050	42	1301.40.330.065	41
1180.63.500	97	1300.16.150.050	42	1301.42.340.115	42
1180.63.500LF	194	1300.17.090.042	40	1301.42.370.070	42
1181.07.060	95	1300.20.130.050	40	1301.42.400.060	42
1181.07.075	95	1300.20.150.050	40	1301.42.400.135	42
1181.09.080	95	1300.21.190.070	42	1301.42.420.140	42
1181.09.100	95	1300.21.220.060	42	1301.48.460.140	42
1181.11.085	95	1300.21.220.080	42	1301.48.465.060	42
1181.11.120	95	1300.25.190.070	40	1301.50.340.115	41
1181.12.060	94	1300.29.260.070	42	1301.50.370.070	41
1181.12.075	94	1300.29.265.090	42	1301.50.400.060	41
1181.13.110	95	1300.29.280.060	42	1301.50.400.135	41
1181.13.140	95	1300.29.300.100	42	1301.50.420.140	41
1181.16.110	95	1300.29.320.090	42	1301.63.460.140	41
1181.16.140	95	1300.29.330.065	42	1301.63.465.060	41
1181.17.080	94	1300.32.220.060	40	1310.020.07	283
1181.17.100	94	1300.32.220.080	40	1310.030.07	283
1181.20.110	94	1300.40.260.070	40	1310.040.07	283
1181.20.140	94	1300.40.265.090	40	1310.050.07	283
1181.21.160	95	1300.40.280.060	40	1310.060.07	283
1181.21.190	95	1300.40.300.100	40	1310.070.07	283
1181.25.160	94	1300.40.320.090	40	1310.080.07	283
1181.25.190	94	1300.40.330.065	40	1310.09.2.030	32
1181.29.230	95	1300.42.340.115	42	1310.09.2.040	32
1181.29.255	95	1300.42.370.070	42	1310.09.2.050	32
1181.32.210	94	1300.42.400.060	42	1310.090.07	283
1181.32.250	94	1300.42.400.135	42	1310.100.07	283
1183.12.050	93	1300.42.420.140	42	1310.11.2.050	32
1183.12.050LF	192	1300.48.460.140	42	1310.11.2.060	32
1183.12.065	93	1300.48.465.060	42	1310.11.2.075	32
1183.12.065LF	192	1300.50.340.115	40	1310.11.3.050	32
1183.17	93	1300.50.370.070	40	1310.110.07	283
1183.17LF	192	1300.50.400.060	40	1310.120.07	283
1183.20	93	1300.50.400.135	40	1310.13.2.050	32
1183.20LF	192	1300.50.420.140	40	1310.13.2.060	32
1183.25	93	1300.63.460.140	40	1310.13.2.075	32
1183.25LF	192	1300.63.465.060	40	1310.13.3.050	32
1183.32	93	1301.09.090.042	42	1310.13.3.060	32
1183.32LF	192	1301.13.130.050	42	1310.13.3.065	32
1183.40	93	1301.13.150.050	42	1310.13.4.050	32
1183.40LF	192	1301.16.130.050	42	1310.13.4.060	32
1183.50	93	1301.16.150.050	42	1310.16.2.050	32
1183.50LF	192	1301.17.090.042	41	1310.16.2.060	32
1183.63	93	1301.20.130.050	41	1310.16.2.075	32
1183.63LF	192	1301.20.150.050	41	1310.16.2.090	32
1184.17	104	1301.21.190.070	42	1310.16.3.050	32
1184.20	104	1301.21.220.060	42	1310.16.3.060	32
1184.25	104	1301.21.220.080	42	1310.16.3.070	32
1184.32	104	1301.25.190.070	41	1310.16.4.050	32
1184.40	104	1301.29.260.070	42	1310.16.4.060	32
1184.50	104	1301.29.265.090	42	1310.16.4.070	32
1184.63	104	1301.29.280.060	42	1310.17.2.030	30
1184.75	104	1301.29.300.100	42	1310.17.2.040	30
1184.80.650	104	1301.29.320.090	42	1310.17.2.050	30
1184.85.700	104	1301.29.330.065	42	1310.20.2.050	30
1189.20.02LF	113	1301.32.220.060	41	1310.20.2.060	30
1189.25.02LF	113	1301.32.220.080	41	1310.20.2.075	30
1189.32.02LF	113	1301.40.260.070	41	1310.20.3.050	30
13...		1301.40.265.090	41	1310.20.3.060	30
1300.09.090.042	42	1301.40.280.060	41	1310.20.3.065	30
1300.13.130.050	42	1301.40.300.100	41	1310.20.4.050	30

Art.-No. Art.-No.	Seite Page	Art.-No. Art.-No.	Seite Page	Art.-No. Art.-No.	Seite Page
1310.20.4.060	30	1311.20.2.060	31	14.583.06	237
1310.21.2.070	32	1311.20.2.075	31	14.583.07	237
1310.21.2.090	32	1311.20.3.050	31	14.583.08	237
1310.21.2.100	32	1311.20.3.060	31	14.583.09	237
1310.21.2.115	32	1311.20.3.065	31	1400.11	44
1310.21.3.070	32	1311.20.4.050	31	1400.16	44
1310.21.3.090	32	1311.20.4.060	31	1400.17	44
1310.21.3.105	32	1311.21.2.070	33	1400.20	44
1310.21.4.070	32	1311.21.2.090	33	1400.21	44
1310.21.4.090	32	1311.21.2.100	33	1400.25	44
1310.21.6.060	32	1311.21.2.115	33	15...	
1310.21.6.070	32	1311.21.3.070	33	1520.17	217
1310.25.2.070	30	1311.21.3.090	33	1520.20	217
1310.25.2.090	30	1311.21.3.105	33	1520.20.080	217
1310.25.2.100	30	1311.21.4.070	33	1520.20.110	217
1310.25.3.070	30	1311.21.4.090	33	1520.25	217
1310.25.3.090	30	1311.21.6.060	33	1520.4.20	71/212
1310.25.4.070	30	1311.21.6.070	33	1520.4.25	71/212
1310.25.6.060	30	1311.25.2.070	31	1540.07.050	221
1310.29.3.090	32	1311.25.2.090	31	1540.07.065	221
1310.32.2.115	30	1311.25.2.100	31	1540.07.080	221
1310.32.3.090	30	1311.25.3.070	31	1540.08.035	216
1310.32.3.105	30	1311.25.3.090	31	1540.08.050	216
1310.32.4.090	30	1311.25.4.070	31	1540.09	221
1310.32.6.070	30	1311.25.6.060	31	1540.09.060	221
1310.40.2.140	30	1311.29.3.090	33	1540.09.080	221
1310.40.4.120	30	1311.32.2.115	31	1540.09.105	221
1310.40.6.080	30	1311.32.3.090	31	1540.10.040	216
1310.50.4.100	30	1311.32.3.105	31	1540.10.060	216
1310.50.7.080	30	1311.32.4.090	31	1540.11	221
1310.63.4.150	30	1311.32.6.070	31	1540.11.055	221
1310.63.8.100	30	1311.40.2.140	31	1540.11.085	221
1310.75.6.180	30	1311.40.4.120	31	1540.11.120	221
1311.09.2.030	33	1311.40.6.080	31	1540.12.050	216
1311.09.2.040	33	1311.50.4.100	31	1540.12.065	216
1311.09.2.050	33	1311.50.7.080	31	1540.12.080	216
1311.11.2.050	33	1311.63.4.150	31	1540.13	221
1311.11.2.060	33	1311.63.8.100	31	1540.13.080	221
1311.11.2.075	33	1311.75.6.180	31	1540.13.110	221
1311.11.3.050	33	1370.15	80	1540.13.150	221
1311.13.2.050	33	1370.15.30	80	1540.16	221
1311.13.2.060	33	1370.15.49.04	80	1540.16.080	221
1311.13.2.075	33	1370.15.49.45	80	1540.16.110	221
1311.13.3.050	33	1370.15.63.12	80	1540.16.150	221
1311.13.3.060	33	14...		1540.17	216
1311.13.3.065	33	14.582.33	237	1540.17.060	216
1311.13.4.050	33	14.582.34	237	1540.17.080	216
1311.13.4.060	33	14.582.35	237	1540.17.105	216
1311.16.2.050	33	14.582.36	237	1540.20	216
1311.16.2.060	33	14.582.37	237	1540.20.080	216
1311.16.2.075	33	14.582.38	237	1540.20.110	216
1311.16.2.090	33	14.582.39	237	1540.20.150	216
1311.16.3.050	33	14.582.93	237	1540.21	221
1311.16.3.060	33	14.582.94	237	1540.21.125	221
1311.16.3.070	33	14.582.95	237	1540.21.160	221
1311.16.4.050	33	14.582.96	237	1540.21.205	221
1311.16.4.060	33	14.582.97	237	1540.25	216
1311.16.4.070	33	14.582.98	237	1540.25.125	216
1311.17.2.030	31	14.582.99	237	1540.25.160	216
1311.17.2.040	31	14.583.03	237	1540.25.205	216
1311.17.2.050	31	14.583.04	237	1540.29	221
1311.20.2.050	31	14.583.05	237	1540.29.190	221

Art.-No. Art.-No.	Seite Page	Art.-No. Art.-No.	Seite Page	Art.-No. Art.-No.	Seite Page
1540.29.230	221	1545.42.38	227	1555.N0375.08	228
1540.29.275	221	1545.48.44	227	1555.N0500.07	228
1540.32	216	1545.50.1.38	226	1555.N0500.12	228
1540.32.170	216	1545.63.1.44	226	1555.N0750.14	228
1540.32.210	216	1545.N0375.08	228	1555.N0750.18	228
1540.32.255	216	1545.N0500.07	228	1555.N1000.22	228
1540.36	221	1545.N0500.12	228	1570.17	217
1540.36.260	221	1545.N0750.14	228	1570.20	217
1540.36.305	221	1545.N0750.18	228	1570.25	217
1540.36.350	221	1545.N1000.22	228	1570.32	217
1540.4.20	71/212	1546.07.06	231	1571.07.050	218
1540.4.25	71/212	1546.09.08	231	1571.07.065	218
1540.4.32	71/212	1546.11.07	231	1571.07.080	218
1540.40	216	1546.11.10	231	1571.08.035	213
1540.40.240	216	1546.12.06	229	1571.08.050	213
1540.40.285	216	1546.12.1.06	230	1571.09	218
1540.40.330	216	1546.13.07	231	1571.09.060	218
1540.42	221	1546.13.12	231	1571.09.080	218
1540.42.330	221	1546.16.11	231	1571.09.105	218
1540.42.370	221	1546.16.14	231	1571.09.2.030	219
1540.42.420	221	1546.17.08	229	1571.09.2.040	219
1540.48	221	1546.17.1.08	230	1571.09.2.050	219
1540.48.370	221	1546.20.07	229	1571.10.040	213
1540.48.430	221	1546.20.1.07	230	1571.10.060	213
1540.48.490	221	1546.20.1.12	230	1571.11	218
1540.50	216	1546.20.12	229	1571.11.055	218
1540.50.330	216	1546.N0375.08	232	1571.11.085	218
1540.50.370	216	1546.N0500.07	232	1571.11.120	218
1540.50.420	216	1546.N0500.12	232	1571.11.2.050	219
1540.63	216	1555.07.06	227	1571.11.2.060	219
1540.63.400	216	1555.09.08	227	1571.11.3.050	219
1540.63.460	216	1555.11.07	227	1571.12.050	213
1540.63.520	216	1555.11.10	227	1571.12.065	213
1545.07.06	227	1555.12.06	225	1571.12.080	213
1545.09.08	227	1555.12.1.06	226	1571.13	218
1545.11.07	227	1555.13.07	227	1571.13.080	218
1545.11.10	227	1555.13.12	227	1571.13.110	218
1545.12.06	225	1555.16.11	227	1571.13.150	218
1545.12.1.06	226	1555.16.14	227	1571.13.2.050	219
1545.13.07	227	1555.17.06	225	1571.13.2.060	219
1545.13.12	227	1555.17.1.06	226	1571.13.2.075	219
1545.16.11	227	1555.17.1.10	226	1571.13.3.050	219
1545.16.14	227	1555.17.10	225	1571.13.3.060	219
1545.17.06	225	1555.20.08	225	1571.13.3.065	219
1545.17.1.06	226	1555.20.1.08	226	1571.13.4.050	219
1545.17.1.10	226	1555.20.1.13	226	1571.13.4.060	219
1545.17.10	225	1555.20.13	225	1571.16	218
1545.20.08	225	1555.21.14	227	1571.16.080	218
1545.20.1.08	226	1555.21.18	227	1571.16.110	218
1545.20.1.13	226	1555.25.1.11	226	1571.16.150	218
1545.20.13	225	1555.25.1.17	226	1571.16.2.050	219
1545.21.14	227	1555.25.11	225	1571.16.2.060	219
1545.21.18	227	1555.25.17	225	1571.16.2.075	219
1545.25.1.11	226	1555.29.25	227	1571.16.3.050	219
1545.25.1.17	226	1555.32.1.25	226	1571.16.3.060	219
1545.25.11	225	1555.32.25	225	1571.16.3.065	219
1545.25.17	225	1555.36.33	227	1571.16.4.050	219
1545.29.25	227	1555.40.1.33	226	1571.16.4.060	219
1545.32.1.25	226	1555.42.38	227	1571.17	213
1545.32.25	225	1555.48.44	227	1571.17.060	213
1545.36.33	227	1555.50.1.38	226	1571.17.080	213
1545.40.1.33	226	1555.63.1.44	226	1571.17.105	213

Art.-No. Art.-No.	Seite Page	Art.-No. Art.-No.	Seite Page	Art.-No. Art.-No.	Seite Page
1571.17.2.030	214	1571.42	218	1572.32	215
1571.17.2.040	214	1571.42.330	218	1572.32.170	215
1571.17.2.050	214	1571.42.370	218	1572.32.210	215
1571.20	213	1571.42.420	218	1572.32.255	215
1571.20.080	213	1571.48	218	1572.36	220
1571.20.110	213	1571.48.370	218	1572.36.260	220
1571.20.150	213	1571.48.430	218	1572.36.305	220
1571.20.2.050	214	1571.48.490	218	1572.36.350	220
1571.20.2.060	214	1571.50	213	1572.40	215
1571.20.2.075	214	1571.50.330	213	1572.40.240	215
1571.20.3.050	214	1571.50.370	213	1572.40.285	215
1571.20.3.060	214	1571.50.420	213	1572.40.330	215
1571.20.3.065	214	1571.63	213	1572.42	220
1571.20.4.050	214	1571.63.400	213	1572.42.330	220
1571.20.4.060	214	1571.63.460	213	1572.42.370	220
1571.21	218	1571.63.520	213	1572.42.420	220
1571.21.125	218	1572.07.050	220	1572.48	220
1571.21.160	218	1572.07.065	220	1572.48.370	220
1571.21.2.070	219	1572.07.080	220	1572.48.430	220
1571.21.2.090	219	1572.08.035	215	1572.48.490	220
1571.21.2.100	219	1572.08.050	215	1572.50	215
1571.21.205	218	1572.09	220	1572.50.330	215
1571.21.3.070	219	1572.09.060	220	1572.50.370	215
1571.21.3.090	219	1572.09.080	220	1572.50.420	215
1571.21.4.070	219	1572.09.105	220	1572.63	215
1571.21.6.060	219	1572.10.040	215	1572.63.400	215
1571.25	213	1572.10.060	215	1572.63.460	215
1571.25.125	213	1572.11	220	1572.63.520	215
1571.25.160	213	1572.11.055	220	1576.07.06	231
1571.25.2.070	214	1572.11.085	220	1576.09.08	231
1571.25.2.090	214	1572.11.120	220	1576.11.07	231
1571.25.2.100	214	1572.12.050	215	1576.11.10	231
1571.25.205	213	1572.12.065	215	1576.12.06	229
1571.25.3.070	214	1572.12.080	215	1576.12.1.06	230
1571.25.3.090	214	1572.13	220	1576.13.07	231
1571.25.4.070	214	1572.13.080	220	1576.13.12	231
1571.25.6.060	214	1572.13.110	220	1576.16.11	231
1571.29	218	1572.13.150	220	1576.16.14	231
1571.29.190	218	1572.16	220	1576.17.08	229
1571.29.230	218	1572.16.080	220	1576.17.1.08	230
1571.29.275	218	1572.16.110	220	1576.20.07	229
1571.29.3.090	219	1572.16.150	220	1576.20.1.07	230
1571.32	213	1572.17	215	1576.20.1.12	230
1571.32.170	213	1572.17.060	215	1576.20.12	229
1571.32.2.115	214	1572.17.080	215	1576.N0375.08	232
1571.32.210	213	1572.17.105	215	1576.N0500.07	232
1571.32.255	213	1572.20	215	1576.N0500.12	232
1571.32.3.090	214	1572.20.080	215	16...	
1571.32.3.105	214	1572.20.110	215	1600.17	238
1571.32.4.090	214	1572.20.150	215	1600.20	238
1571.32.6.070	214	1572.21	220	1600.25	238
1571.36	218	1572.21.125	220	1600.32	238
1571.36.260	218	1572.21.160	220	1600.40	238
1571.36.305	218	1572.21.205	220	1600.50	238
1571.36.350	218	1572.25	215	1600.63	238
1571.4.20	71/212	1572.25.125	215	1620.17	238
1571.4.25	71/212	1572.25.160	215	1620.20	238
1571.4.32	71/212	1572.25.205	215	1620.25	238
1571.40	213	1572.29	220	1620.32	238
1571.40.240	213	1572.29.190	220	1620.40	238
1571.40.285	213	1572.29.230	220	1620.50	238
1571.40.330	213	1572.29.275	220	1620.63	238

Art.-No. Art.-No.	Seite Page	Art.-No. Art.-No.	Seite Page	Art.-No. Art.-No.	Seite Page
17...		1710.80.09.080.1	205	1800.10.13.060	49
1700.07.10	200	1710.80.09.100.1	205	1800.10.16	54
1700.09.14	200	1710.80.11.085.1	205	1800.10.17	53
1700.11.14	200	1710.80.11.120.1	205	1800.10.20	53
1700.11.17	200	1710.80.12.060.1	203	1800.10.21	54
1700.12.1/4	198	1710.80.12.060.2	204	1800.10.25	53
1700.12.10	198	1710.80.13.110.1	205	1800.10.29	54
1700.13.19	200	1710.80.13.140.1	205	1800.10.32	53
1700.16.17	200	1710.80.16.110.1	205	1800.10.40	53
1700.16.21	200	1710.80.16.140.1	205	1800.11.03.120	50
1700.17.14	198	1710.80.17.080.1	203	1800.11.09	54
1700.20.1/2	198	1710.80.17.080.2	204	1800.11.11	54
1700.20.17	198	1710.80.17.100.1	203	1800.11.13	54
1700.20.19	198	1710.80.17.100.2	204	1800.11.13.120	51
1700.20.21	198	1710.80.20.110.1	203	1800.11.16	54
1700.20.3/8	198	1710.80.20.110.2	203	1800.11.17	53
1700.21.27	200	1710.80.20.110.3	204	1800.11.20	53
1700.25.21	198	1710.80.20.110.4	204	1800.11.21	54
1700.25.27	198	1710.80.20.140.1	203	1800.11.25	53
1700.25.3/4	198	1710.80.20.140.2	203	1800.11.29	54
1700.29.36	200	1710.80.20.140.4	204	1800.11.32	53
1700.32.1	198	1710.80.21.160.1	205	1800.11.40	53
1700.32.27	198	1710.80.21.190.1	205	1800.12.03.065	48
1700.36.45	200	1710.80.25.160.1	203	1800.12.03.080	48
1700.40.11/4	198	1710.80.25.160.2	204	1800.12.13.065	49
1700.40.36	198	1710.80.25.190.1	203	1800.12.13.080	49
1700.42.45	200	1710.80.25.190.2	204	1800.13.03.150	50
1700.48.56	200	1710.80.29.230.1	205	1800.13.13.150	51
1700.50.45	198	1710.80.29.255.1	205	1800.16.03.150	50
1700.63.2	198	1710.80.32.210.1	203	1800.16.13.150	51
1700.63.56	198	1710.80.32.210.2	204	1800.17.03.105	48
1710.60.07.10	200	1710.80.32.250.1	203	1800.17.13.105	49
1710.60.09.14	200	1710.80.32.250.2	204	1800.20.03.150	48
1710.60.11.14	200	1710.80.36.305.1	205	1800.20.13.150	49
1710.60.11.17	200	1710.80.36.350.1	205	1800.21.03.205	50
1710.60.12.1/4	199	1710.80.40.285.1	203	1800.21.13.205	51
1710.60.12.10	199	1710.80.40.285.2	204	1800.25.03.205	48
1710.60.13.19	200	1710.80.40.320.1	203	1800.25.13.205	49
1710.60.16.17	200	1710.80.40.320.2	204	1800.29.03.275	50
1710.60.16.21	200	1710.80.42.370.1	205	1800.29.13.275	51
1710.60.17.14	199	1710.80.42.410.1	205	1800.32.03.255	48
1710.60.20.1/2	199	1710.80.48.430.1	205	1800.32.13.255	49
1710.60.20.17	199	1710.80.48.465.1	205	1800.36.03.350	50
1710.60.20.19	199	1710.80.50.370.1	203	1800.36.13.350	51
1710.60.20.21	199	1710.80.50.410.1	203	1800.40.03.330	48
1710.60.20.3/8	199	1710.80.63.460.1	203	1800.40.13.330	49
1710.60.21.27	200	1710.80.63.460.2	204	1800.42.03.410	50
1710.60.25.21	199	1710.80.63.500.1	203	1800.42.13.410	51
1710.60.25.27	199	1710.80.63.500.2	204	1800.48.03.490	50
1710.60.25.3/4	199	18...		1800.48.13.490	51
1710.60.29.36	200	1800.07.03.065	50	1800.50.03.410	48
1710.60.32.1	199	1800.07.03.080	50	1800.50.13.410	49
1710.60.32.27	199	1800.07.13.065	51	1800.63.03.520	48
1710.60.36.45	200	1800.07.13.080	51	1800.63.13.520	49
1710.60.40.11/4	199	1800.09.03.105	50	1800.75.03.630	48
1710.60.40.36	199	1800.09.13.105	51	1800.75.13.630	49
1710.60.42.45	200	1800.10.03.040	48	1801.09	84
1710.60.48.56	200	1800.10.03.060	48	1801.10.09	56
1710.60.50.45	199	1800.10.09	54	1801.10.11	56
1710.60.63.2	199	1800.10.11	54	1801.10.13	56
1710.60.63.56	199	1800.10.13	54	1801.10.16	56
1710.80.07.060.1	205	1800.10.13.040	49	1801.10.17	55

Art.-No. Art.-No.	Seite Page	Art.-No. Art.-No.	Seite Page	Art.-No. Art.-No.	Seite Page
1801.10.20	55	1816.02	52	1852.25.20	85
1801.10.21	56	1816.26	147	1852.29.20	85
1801.10.25	55	1817.02	52	1852.29.23	85
1801.10.29	56	1817.09.26	147	1852.29.25	85
1801.10.32	55	181G.29.26	148	1852.32.23	85
1801.10.40	55	181NPT.21.26	148	1852.32.25	85
1801.11	84	181NPT.21.27	148	1852.36.26	85
1801.11.09	56	1820.02	52	1852.36.30	85
1801.11.11	56	1820.11.26	147	1852.36.33	85
1801.11.13	56	1820.16.26	147	1852.36.35	85
1801.11.16	56	1821.02	52	1852.40.26	85
1801.11.17	55	1821.26	147	1852.40.30	85
1801.11.20	55	1821.27	147	1852.40.33	85
1801.11.21	56	1825.02	52	1852.40.35	85
1801.11.25	55	1825.21.26	147	1852.42.35	85
1801.11.29	56	1825.21.27	147	1852.42.38	85
1801.11.32	55	1829.02	52	1852.42.40	85
1801.11.40	55	1829.26	147	1863.48.26	147
1801.13	84	1829.27	147	1863.48.27	147
1801.16	84	183/4G.21.26	148	19...	
1801.17	84	183/4G.21.27	148	1900.19.30.03	121
1801.20.10	84	183/4NPT.11.26	148	1900.23.30.03	121
1801.20.12	84	183/4NPT.16.26	148	1900.26.30.03	121
1801.20.14	84	183/4NPT.21.26	148	1900.34.30.03	121
1801.21	84	183/8G.09.26	148	1908.88.03.005	121
1801.25	84	183/8NPT.09.26	148	1908.88.03.006	121
1801.29	84	1832.02	52	1908.88.08.002	121
1801.32	84	1832.29.26	147	1908.88.08.003	121
1803.07	83	1836.02	52	1908.88.08.004	121
1803.09	83	1836.26	147	1908.88.10.001	121
1803.11	83	1836.27	147	21...	
1803.12	83	1840.02	52	2111.00.08	278
1803.13	83	1840.29.27	147	2111.98.08	279
1803.16	83	1848.26	148	24...	
1803.17	83	1848.27	148	2410.17	246
1803.20	83	1848.48.26	147	2410.20	246
1803.21	83	1848.48.27	147	2410.25	246
1803.25	83	1850.36.26	147	2410.32	246
1803.29	83	1850.36.27	147	2410.40	246
1803.32	83	1852.07.05	85	2410.50	246
1803.36	83	1852.09.07	85	2445.12	242
1803.40	83	1852.11.07	85	2450.07.32	244
1803.42	83	1852.11.09	85	2450.07.34	243
1803.48.48	83	1852.12.05	85	2450.11.32	244
1807.02	52	1852.13.09	85	2450.11.34	243
1809.02	52	1852.13.11	85	2450.12.32	244
1809.26	147	1852.13.13	85	2450.12.34	243
181/2G.11.26	148	1852.16.07	85	2450.12.36	245
181/2G.16.26	148	1852.16.13	85	2450.17.32	244
181/2NPT.11.26	148	1852.16.15	85	2450.17.34	243
181/2NPT.16.26	148	1852.20.07	85	2450.17.36	245
1811.02	52	1852.20.09	85	2450.20.32	244
1811.26	147	1852.20.11	85	2450.20.34	243
1811/2G.36.26	148	1852.20.13	85	2450.20.36	245
1811/2NPT.36.26	148	1852.20.15	85	2455.12	242
1811/2NPT.36.27	148	1852.21.15	85	34...	
1811/4G.29.27	148	1852.21.17	85	3409.07	266
1811/4NPT.29.26	148	1852.21.19	85	3411.07	266
1811/4NPT.29.27	148	1852.21.20	85	3411.09	266
1812.02	52	1852.21.20	85	3413.09	266
1813.02	52	1852.25.15	85	3413.11	266
1813.26	147	1852.25.17	85	3416.09	266
		1852.25.19	85		

Art.-No. Art.-No.	Seite Page	Art.-No. Art.-No.	Seite Page	Art.-No. Art.-No.	Seite Page
3416.11	266	3500.16.12	261	3529.16	257
3416.13	266	3500.16.17	261	3529.21	257
3417.09	268	3500.16.20	261	352G.36	264
3420.11	268	3500.17.07	260	352G.42	264
3421.13	266	3500.17.10	256	353/4G.09	264
3421.16	266	3500.17.12	256	353/4G.11	264
3425.16	268	3500.20.07	260	353/4G.16	264
3429.21	266	3500.20.09	260	353/4NPT.11	265
3436.29	266	3500.20.11	260	353/4NPT.13	265
3440.29	268	3500.20.12	256	353/8G.07	264
3450.36	268	3500.20.17	256	3536.21	257
3455.09.12	269	3500.21.17	261	3536.29	257
3455.11.17	269	3500.21.20	261	3542.29	257
3455.13.17	269	3500.21.25	261	3542.36	257
3455.13.20	269	3500.25.09	260	3545.11.17	263
3455.16.20	269	3500.25.11	260	3545.16.20	263
3455.17.12	266	3500.25.13	260	3545.17.12	257
3455.20.12	266	3500.25.16	260	3545.20.12	257
3455.20.17	266	3500.25.17	256	3545.20.17	257
3455.21.25	269	3500.25.20	256	3545.21.20	263
3455.25.12	266	3500.29.25	261	3545.21.25	263
3455.25.17	266	3500.29.32	261	3545.25.17	257
3455.25.20	266	3500.32.20	256	3545.25.20	257
3455.29.32	269	3500.32.21	260	3545.29.25	263
3455.32.12	266	3500.32.25	256	3545.29.32	263
3455.32.17	266	3500.36.32	261	3545.32.20	257
3455.32.20	266	3500.36.40	261	3545.32.25	257
3455.32.25	266	3500.40.25	256	3545.36.40	263
3455.36.40	269	3500.40.29	260	3545.40.25	257
3455.40.17	266	3500.40.32	256	3545.40.32	257
3455.40.20	266	3500.42.32	261	3545.50.32	257
3455.40.25	266	3500.42.40	261	3545.50.40	257
3455.40.32	266	3500.42.50	261	3545.63.40	257
3455.50.20	266	3500.48.40	261	3545.63.50	257
3455.50.25	266	3500.48.50	261	3548.48.36	257
3455.50.32	266	3500.50.29	260	36...	
3455.50.40	266	3500.50.32	256	3600.06.08	258
3455.63.25	266	3500.50.40	256	3600.06.10	258
3455.63.32	266	3500.63.36	260	3600.07.12	262
3455.63.40	266	3500.63.40	256	3600.07.17	262
3455.63.50	266	3500.63.50	256	3600.08.10	258
3463.48	268	3500.75.50	256	3600.08.12	258
35...		3500.75.63	256	3600.09.17	262
3500.07.06	261	3509.07	257	3600.09.20	262
3500.07.08	261	351/2G.09	264	3600.10.07	260
3500.07.10	261	351/2NPT.09	265	3600.10.09	260
3500.08.06	256	3511.07	257	3600.10.12	258
3500.09.06	261	3511.09	257	3600.10.17	258
3500.09.08	261	3511/4G.29	264	3600.11.20	262
3500.09.10	261	3513.07	257	3600.11.25	262
3500.09.12	261	3513.09	257	3600.12.09	260
3500.10.06	256	3513.11	257	3600.12.17	258
3500.10.08	256	35133/8G	264	3600.12.20	258
3500.11.06	261	3516.09	257	3600.13.20	262
3500.11.08	261	3516.11	257	3600.13.25	262
3500.11.10	261	3516.13	257	3600.16.25	262
3500.11.12	261	351G.21	264	3600.16.32	262
3500.11.17	261	351NPT.16	265	3600.17.11	260
3500.12.08	256	3521.11	257	3600.17.20	258
3500.12.10	256	3521.13	257	3600.20.13	260
3500.13.12	261	3521.16	257	3600.20.16	260
3500.13.17	261	3529.13	257	3600.20.25	258

Art.-No. Art.-No.	Seite Page
3600.21.32	262
3600.21.40	262
3600.25.21	260
3600.25.32	258
3600.29.40	262
3600.29.50	262
3600.32.29	260
3600.32.40	258
3600.36.50	262
3600.36.63	262
3600.40.36	260
3600.40.50	258
3600.42.63	262
3600.42.75	262
3600.48.63	262
3600.48.75	262
3600.50.42	260
3600.50.48	260
3600.50.63	258
3600.63.75	258
3607.09.08	259
3609.11.08	259
3609.13.08	259
361/2G.11.08	264
361/2G.13.08	264
361/2G.16.08	264
361/2NPT.11	265
361/2NPT.13	265
361/2NPT.16	265
3611.13.08	259
3611.16.08	259
3611.21.08	259
3611/2G.36.08	264
3613.16.08	259
3613.21.08	259
3616.21.08	259
3616.29.08	259
36161/2G.08	264
361G.29.08	264
3621.29.08	259
36213/4G.08	264
3629.36.08	259
363/4G.21.08	264
363/4NPT.21	265
363/8G.11.08	264
3636.42.08	259
3636.48.08	264
3636.48.48.08	259
3642.48.08	264
3645.07.12	263
3645.09.17	263
3645.11.20	263
3645.12.17	258
3645.13.20	263
3645.16.25	263
3645.17.20	258
3645.20.25	258
3645.21.32	263
3645.25.32	258
3645.29.40	263
3645.32.40	258
3645.40.50	258

Art.-No. Art.-No.	Seite Page
3645.50.63	258
365/8G.16.08	264
367/8G.29.08	264
37...	
3707.09	267
3709.11	267
3711.13	267
3712.09	268
3713.16	267
3716.21	267
3720.13	268
3720.16	268
3721.29	267
3725.21	268
3729.36	267
3732.29	268
3736.42	267
3742.48	267
3750.42	268
3755.07.12	269
3755.07.17	269
3755.09.17	269
3755.09.20	269
3755.11.20	269
3755.12.17	267
3755.13.25	269
3755.16.25	269
3755.17.20	267
3755.20.25	267
3755.21.32	269
3755.25.32	267
3755.29.40	269
3755.32.40	267
3755.40.50	267
3755.42.50	269
3755.48.63	269
3755.50.63	267
48...	
4800.24	284
4800.36	284
4801.00.01	115
4801.00.02	115
4801.01	117
4801.02EU	117
4801.098.01	116
4801.103.01	116
4801.114.01	116
4801.132.01	116
4801.146.01	116
4801.154.01	116
4801.160.01	116
4801.175.01	116
4801.184.01	116
4801.20.01	116
4801.200.01	116
4801.210.01	116
4801.227.01	116
4801.231.01	116
4801.25.01	116
4801.32.01	116
4801.900	115
4801.EU	118

Art.-No. Art.-No.	Seite Page
50...	
5000.17.50	246
5000.20.50	246
5000.25.50	246
5000.32.50	246
5030.013.010	209
5030.013.014	209
5030.013.017	209
5030.013.021	209
5030.013.027	209
5030.013.036	209
5030.013.045	209
5030.013.056	209
5031.034.007	209
5031.034.009	209
5031.034.011	209
5031.034.013	209
5031.034.016	209
5031.034.021	209
5031.034.029	209
5031.034.036	209
5031.034.048	209
52...	
5200.07	75
5200.09	75
5200.11	75
5200.12	74
5200.13	75
5200.16	75
5200.17	74
5200.20	74
5200.21	75
5200.25	74
5200.29	75
5200.32	74
5200.40	74
5210.07	75
5210.09	75
5210.11	75
5210.12	74
5210.13	75
5210.16	75
5210.17	74
5210.20	74
5210.21	75
5210.25	74
5210.29	75
5210.32	74
5210.40	74
5215.07	76
5215.09	76
5215.09.65	235
5215.09.95	235
5215.11	76
5215.11.105	235
5215.11.65	235
5215.11.95	235
5215.12	76
5215.13	76
5215.13.105	235
5215.13.13	235
5215.13.95	235

Art.-No. Art.-No.	Seite Page	Art.-No. Art.-No.	Seite Page	Art.-No. Art.-No.	Seite Page
5215.16	76	5613	77	6875.80.20	288
5215.16.105	235	5616	77	6875.80.25	288
5215.16.13	235	5617	77	6875.80.35	288
5215.16.155	235	5620	77	6875.80.45	288
5215.16.95	235	5621	77	6879.40.05	290
5215.17	76	5625	77	6879.40.08	290
5215.17.40.95	235	5629	77	6879.40.10	290
5215.17.95	235	5632	77	6879.40.13	290
5215.20	76	5636	77	6879.40.16	290
5215.20.105	235	5640	77	6879.40.19	290
5215.20.13	235	5650	77	6879.40.25	290
5215.20.40.105	235	57...		6879.40.29	290
5215.20.40.13	235	5711	78	6879.40.32	290
5215.21	76	5716	78	6879.40.38	290
5215.25	76	5717	78	6879.40.50	290
5215.25.155	235	5720	78	6879.80.08	291
5215.25.40.155	235	5721	78	6879.80.13	291
5215.29	76	5725	78	6879.80.16	291
5215.32	76	5729	78	6879.80.19	291
5215.40	76	5732	78	6879.80.25	291
55...		68...		6879.80.29	291
5500.20.17	236	6850.40.03	289	6879.80.32	291
5500.20.20	236	6850.40.04	289	6879.80.38	291
5500.20.25	236	6850.40.05	289	6879.80.50	291
5500.20.32	236	6850.40.06	289	80...	
5500.20.40	236	6850.40.10	289	8000.06	247
5500.20.50	236	6850.40.12	289	8000.06.1	247
5500.40.17	236	6850.40.16	289	8000.08	247
5500.40.20	236	6850.40.22	289	8000.08.1	247
5500.40.25	236	6850.40.24	289	8000.080	247
5500.40.32	236	6850.40.30	289	8000.085	247
5500.40.40	236	6850.40.35	289	8000.095	247
5500.40.50	236	6850.40.45	289	8000.10	247
5516.10	79	6850.40.50	289	8000.10.1	247
5516.12	79	6850.40.70	289	8000.100	247
5516.13	79	6875.40.03	287	8000.105	247
5517	79	6875.40.05	287	8000.115	247
5520	79	6875.40.05.10	288	8000.12	247
5520.11	236	6875.40.08	287	8000.12LF	195
5520.16	236	6875.40.10	287	8000.17	247
5520.21	236	6875.40.10.10	288	8000.17LF	195
5520.29	236	6875.40.15	287	8000.20	247
5520.36	236	6875.40.18.06	288	8000.20LF	195
5521.10	79	6875.40.20	287	8000.25	247
5525	79	6875.40.24	287	8000.25LF	195
5529.10	79	6875.40.30.06	288	8000.32	247
5532	79	6875.40.36	287	8000.32LF	195
5536.10	79	6875.40.50	287	8000.40	247
5540	79	6875.70.03	287	8000.40LF	195
5540.11	236	6875.70.05	287	8000.50	247
5540.16	236	6875.70.08	287	8000.50LF	195
5540.21	236	6875.70.10	287	8000.63	247
5540.29	236	6875.70.15	287	8000.63LF	195
5540.36	236	6875.70.20	287	8000.75	247
5540.48.48	236	6875.70.24	287	8007	247
5550	79	6875.70.36	287	8007.85	107
5563	79	6875.70.50	287	8007.96	250
56...		6875.80.05	288	8008.85	107
5607	77	6875.80.08	288	8008.96	250
5609	77	6875.80.10	288	8008.98	251
5611	77	6875.80.12	288	8009	247
5612	77	6875.80.16	288	8009.85	107

Art.-No. Art.-No.	Seite Page	Art.-No. Art.-No.	Seite Page	Art.-No. Art.-No.	Seite Page
8009.96	250	8050.98	251	8255.12	254
801/2G	248	8051	248	8255.13	255
8010.85	107	8063.85	107	8255.16	255
8010.96	250	8063.85LF	195	8255.17	254
8010.98	251	8063.96	250	8255.20	254
8011	247	8063.98	251	8255.21	255
8011.85	107	82...		8255.25	254
8011.96	250	8207	253	8255.29	255
8011/2G	248	8207.40	253	8255.32	254
8011/4G	248	8209	253	8255.36	255
8012.85	107	8209.40	253	8255.40	254
8012.85LF	195	8211	253	8255.42	255
8012.96	250	8211.40	253	8255.48	255
8012.98	251	8212	252	8255.50	254
8013	247	8212.40	252	8255.63	254
8013.85	107	8213	253	83...	
8013.96	250	8213.40	253	8300.07	248
8016	247	8216	253	8300.09	248
8016.85	107	8216.40	253	8300.11	248
8016.96	250	8217	252	8300.12	248
8017.85	107	8217.40	252	8300.12.1	249
8017.85LF	195	8220	252	8300.13	248
8017.96	250	8220.40	252	8300.16	248
8017.98	251	8221	253	8300.17	248
801G	248	8221.40	253	8300.17.1	249
8020.85	107	8225	252	8300.20	248
8020.85LF	195	8225.40	252	8300.20.1	249
8020.96	250	8229	253	8300.21	248
8020.98	251	8229.40	253	8300.25	248
8021	247	8232	252	8300.25.1	249
8021.85	107	8232.40	252	8300.29	248
8021.96	250	8236	253	8300.32	248
8025.85	107	8236.40	253	8300.32.1	249
8025.85LF	195	8240	252	8300.40	248
8025.96	250	8240.40	252	8300.40.1	249
8025.98	251	8242	253	8300.50.1	249
8029	247	8242.40	253	8300.63.1	249
8029.85	107	8245.07	255	8324.12	245
8029.96	250	8245.09	255	8324.17	245
803/4G	248	8245.11	255	8324.20	245
803/8G	248	8245.12	254	87...	
8032.85	107	8245.13	255	8706.08	270
8032.85LF	195	8245.16	255	8706.11.08	270
8032.96	250	8245.17	254	8707.08	271
8032.98	251	8245.20	254	8707.11.08	272
8036	247	8245.21	255	8708.08	270
8036.85	107	8245.25	254	8708.11.08	270
8036.96	250	8245.29	255	8709.08	271
8040.85	107	8245.32	254	8709.11.08	272
8040.85LF	195	8245.36	255	8710.07	152
8040.96	250	8245.40	254	8710.08	270
8040.98	251	8245.42	255	8710.09	152
8042	247	8245.48	255	8710.11	152
8042.85	107	8245.50	254	8710.11.08	270
8048	248	8245.63	254	8710.12	152
8048.48	247	8248.48	253	8710.13	152
8048.85	107	8248.48.40	253	8710.16	152
805/8G	248	8250	252	8710.17	152
8050	248	8250.40	252	8710.20	152
8050.85	107	8255.07	255	8710.21	152
8050.85LF	195	8255.09	255	8710.25	152
8050.96	250	8255.11	255	8710.29	152

Art.-No. Art.-No.	Seite Page	Art.-No. Art.-No.	Seite Page	Art.-No. Art.-No.	Seite Page
8710.32	152	8745.32	271	8855.20	275
8710.36	152	8745.40	271	8855.25	275
8710.40	152	8745.50	271	8855.32	275
8710.50	152	8745.63	271	8855.40	275
8710.63	152	8748.08	271	8855.50	275
8710.96.08	274	8748.48.08	271	8855.63	275
8710.96.08.70	273	8750.08	270	B...	
8710.96.11.08	274	8750.11.08	270	B 107	82
8710.96.11.08.70	273	8750.96.08	274	B 107.00.03	282
8711.08	271	8750.96.08.70	273	B 109	82
8711.11.08	272	8750.96.11.08	274	B 109.00.03	282
8712.08	270	8750.96.11.08.70	273	B 111	82
8712.11.08	270	8763.08	270	B 111.00.03	282
8712.96.08	274	8763.11.08	270	B 112	81
8712.96.08.70	273	8763.96.08	274	B 113	82
8712.96.11.08	274	8763.96.08.70	273	B 113.00.03	282
8712.96.11.08.70	273	8763.96.11.08	274	B 116	82
8713.08	271	8763.96.11.08.70	273	B 116.00.03	282
8713.11.08	272	8775.08	270	B 117	81
8716.08	271	8775.11.08	270	B 120.10	81
8716.11.08	272	8775.96.08	274	B 120.12	81
8717.08	270	8775.96.08.70	273	B 120.14	81
8717.11.08	270	8775.96.11.08	274	B 121	82
8717.96.08	274	8775.96.11.08.70	273	B 121.00.03	282
8717.96.08.70	273	88...		B 125	81
8717.96.11.08	274	8807	275	B 129	82
8717.96.11.08.70	273	8809	275	B 129.00.03	282
8720.08	270	8811	275	B 132	81
8720.11.08	270	8813	275	B 136	82
8720.96.08	274	8816	275	B 136.00.03	282
8720.96.08.70	273	8821	275	B 140	81
8720.96.11.08	274	8829	275	B 142	82
8720.96.11.08.70	273	8836	275	B 142.00.03	282
8721.08	271	8841.07	185	B 148.00.03	282
8721.11.08	272	8841.09	185	B 148.48	82
8725.08	270	8841.11	185	B 150	81
8725.11.08	270	8841.12	185	B 163	81
8725.96.08	274	8841.13	185	B 209	82
8725.96.08.70	273	8841.16	185	B 211	82
8725.96.11.08	274	8841.17	185	B 212	81
8725.96.11.08.70	273	8841.20	185	B 213	82
8729.08	271	8841.21	185	B 216	82
8729.11.08	272	8841.25	185	B 217	81
8732.08	270	8841.29	185	B 220.10	81
8732.11.08	270	8841.32	185	B 220.12	81
8732.96.08	274	8841.36	185	B 220.14	81
8732.96.08.70	273	8841.40	185	B 221	82
8732.96.11.08	274	8841.42	185	B 225	81
8732.96.11.08.70	273	8841.48	185	B 229	82
8736.08	271	8841.50	185	B 232	81
8736.11.08	272	8841.63	185	B 236	82
8740.08	270	8842	275	B 240	81
8740.11.08	270	8845.12	275	B 242	82
8740.96.08	274	8845.17	275	B 248.48	82
8740.96.08.70	273	8845.20	275	B 250	81
8740.96.11.08	274	8845.25	275	B 263	81
8740.96.11.08.70	273	8845.32	275	EX...	
8742.08	271	8845.40	275	EX1000.07.065	155
8745.12	271	8845.50	275	EX1000.07.080	155
8745.17	271	8845.63	275	EX1000.08.035	153
8745.20	271	8855.12	275	EX1000.08.050	153
8745.25	271	8855.17	275	EX1000.09.060	155

Art.-No. Art.-No.	Seite Page	Art.-No. Art.-No.	Seite Page	Art.-No. Art.-No.	Seite Page
EX1000.09.080	155	EX1081.12.060	163	EX1126.3/4NPT.150	151
EX1000.10.040	153	EX1081.12.075	163	EX1126.3/4NPT.180	151
EX1000.10.060	153	EX1081.13.110	163	EX1126.3/8NPT.070	151
EX1000.11.055	155	EX1081.13.140	163	EX1126.3/8NPT.100	151
EX1000.11.085	155	EX1081.16.110	163	EX1126.32.230	149
EX1000.12.065	153	EX1081.16.140	163	EX1126.32.260	149
EX1000.12.080	153	EX1081.17.080	163	EX1126.40.260	149
EX1000.13.080	155	EX1081.17.100	163	EX1126.40.320	149
EX1000.13.110	155	EX1081.20.110	163	EX1126.50.360	149
EX1000.16.080	155	EX1081.20.140	163	EX1126.50.420	149
EX1000.16.110	155	EX1081.21.160	163	EX1126.63.440	149
EX1000.17.060	153	EX1081.21.190	163	EX1126.63.500	149
EX1000.17.080	153	EX1081.25.160	163	EX1310.015.07	170/283
EX1000.20.080	153	EX1081.25.190	163	EX1310.030.07	170/283
EX1000.20.110	153	EX1081.29.230	163	EX1310.040.07	170/283
EX1000.21.125	155	EX1081.29.255	163	EX1310.050.07	170/283
EX1000.21.160	155	EX1081.32.210	163	EX1310.060.07	170/283
EX1000.25.125	153	EX1100.07.065	156	EX1310.070.07	170/283
EX1000.25.160	153	EX1100.07.080	156	EX1310.09.2.030	158
EX1000.29.190	155	EX1100.08.035	154	EX1310.09.4.015	158
EX1000.29.230	155	EX1100.08.050	154	EX1310.090.07	170/283
EX1000.32.170	153	EX1100.09.060	156	EX1310.100.07	170/283
EX1000.32.210	153	EX1100.09.080	156	EX1310.11.2.040	158
EX1000.36.260	155	EX1100.10.040	154	EX1310.11.2.050	158
EX1000.36.305	155	EX1100.10.060	154	EX1310.11.3.030	158
EX1000.40.240	153	EX1100.11.055	156	EX1310.12.3.010	157
EX1000.40.285	153	EX1100.11.085	156	EX1310.120.07	170/283
EX1080.07.060	165	EX1100.12.065	154	EX1310.13.2.050	158
EX1080.07.075	165	EX1100.12.080	154	EX1310.13.3.040	158
EX1080.08.035	164	EX1100.13.080	156	EX1310.150.07	170/283
EX1080.08.040	164	EX1100.13.110	156	EX1310.16.2.060	158
EX1080.09.080	165	EX1100.16.080	156	EX1310.16.3.060	158
EX1080.09.100	165	EX1100.16.110	156	EX1310.16.6.030	158
EX1080.10.040	164	EX1100.17.060	154	EX1310.16.6.040	158
EX1080.10.060	164	EX1100.17.080	154	EX1310.17.2.030	157
EX1080.11.085	165	EX1100.20.080	154	EX1310.17.4.015	157
EX1080.11.120	165	EX1100.20.110	154	EX1310.180.07	170/283
EX1080.12.060	164	EX1100.21.125	156	EX1310.20.2.050	157
EX1080.12.075	164	EX1100.21.160	156	EX1310.20.2.075	157
EX1080.13.110	165	EX1100.25.125	154	EX1310.20.3.060	157
EX1080.13.140	165	EX1100.25.160	154	EX1310.20.4.050	157
EX1080.16.110	165	EX1100.29.190	156	EX1310.20.6.030	157
EX1080.16.140	165	EX1100.29.230	156	EX1310.21.3.090	158
EX1080.17.080	164	EX1100.32.170	154	EX1310.21.4.070	158
EX1080.17.100	164	EX1100.32.210	154	EX1310.25.2.100	157
EX1080.20.110	164	EX1100.36.260	156	EX1310.25.3.070	157
EX1080.20.140	164	EX1100.36.305	156	EX1310.25.3.090	157
EX1080.21.160	165	EX1100.40.240	154	EX1310.25.4.070	157
EX1080.21.190	165	EX1100.40.285	154	EX1310.25.6.060	157
EX1080.25.160	164	EX1126.1/2NPT.110	151	EX1310.29.3.090	158
EX1080.25.190	164	EX1126.1/2NPT.140	151	EX1310.29.6.065	158
EX1080.29.230	165	EX1126.11/2NPT.360	151	EX1310.32.4.090	157
EX1080.29.255	165	EX1126.11/4NPT.320	151	EX1310.32.6.070	157
EX1080.32.210	164	EX1126.17.070	149	EX1310.36.2.150	158
EX1080.36.305	165	EX1126.17.100	149	EX1310.36.4.100	158
EX1080.40.285	164	EX1126.1NPT.230	151	EX1310.40.2.150	157
EX1081.07.060	163	EX1126.1NPT.260	151	EX1310.40.7.090	157
EX1081.07.075	163	EX1126.20.110	149	EX1310.48.3.180	158
EX1081.09.080	163	EX1126.20.140	149	EX1310.48.6.120	158
EX1081.09.100	163	EX1126.25.150	149	EX1310.50.4.100	157
EX1081.11.085	163	EX1126.25.180	149	EX1310.63.3.180	157
EX1081.11.120	163	EX1126.2NPT.440	151	EX1310.63.6.120	157

Art.-No. Art.-No.	Seite Page	Art.-No. Art.-No.	Seite Page	Art.-No. Art.-No.	Seite Page
EX1530.09.060	179	EX1540.13.2.050	177	EX1540.48.6.120	177
EX1530.09.080	179	EX1540.13.3.040	177	EX1540.50.350	172
EX1530.11.055	179	EX1540.16.080	174	EX1540.50.370	172
EX1530.11.085	179	EX1540.16.110	174	EX1540.50.390	172
EX1530.13.080	179	EX1540.16.3.060	177	EX1540.50.4.100	175
EX1530.13.110	179	EX1540.16.6.030	177	EX1540.50.420	172
EX1530.16.080	179	EX1540.17.060	172	EX1540.63.3.180	175
EX1530.16.110	179	EX1540.17.080	172	EX1540.63.440	172
EX1530.17.060	178	EX1540.17.2.030	175	EX1540.63.460	172
EX1530.17.080	178	EX1540.17.4.015	175	EX1540.63.480	172
EX1530.20.080	178	EX1540.20.080	172	EX1540.63.520	172
EX1530.20.110	178	EX1540.20.110	172	EX1540.63.6.120	175
EX1530.21.125	179	EX1540.20.2.050	175	EX1571.09.060	173
EX1530.21.160	179	EX1540.20.6.030	175	EX1571.09.080	173
EX1530.21.190	179	EX1540.21.125	174	EX1571.09.2.030	176
EX1530.21.205	179	EX1540.21.160	174	EX1571.09.4.015	176
EX1530.25.125	178	EX1540.21.190	174	EX1571.11.055	173
EX1530.25.160	178	EX1540.21.205	174	EX1571.11.085	173
EX1530.25.190	178	EX1540.21.3.090	177	EX1571.11.2.050	176
EX1530.25.205	178	EX1540.21.4.070	177	EX1571.11.3.030	176
EX1530.29.210	179	EX1540.25.125	172	EX1571.13.080	173
EX1530.29.230	179	EX1540.25.160	172	EX1571.13.110	173
EX1530.29.250	179	EX1540.25.190	172	EX1571.13.2.050	176
EX1530.29.275	179	EX1540.25.2.100	175	EX1571.13.3.040	176
EX1530.32.210	178	EX1540.25.205	172	EX1571.16.080	173
EX1530.32.220	178	EX1540.25.3.090	175	EX1571.16.110	173
EX1530.32.230	178	EX1540.25.4.070	175	EX1571.16.3.060	176
EX1530.32.255	178	EX1540.25.6.060	175	EX1571.16.6.030	176
EX1530.36.285	179	EX1540.29.210	174	EX1571.17.060	171
EX1530.36.305	179	EX1540.29.230	174	EX1571.17.080	171
EX1530.36.325	179	EX1540.29.250	174	EX1571.17.2.030	175
EX1530.36.350	179	EX1540.29.275	174	EX1571.17.4.015	175
EX1530.40.270	178	EX1540.29.3.090	177	EX1571.20.080	171
EX1530.40.285	178	EX1540.29.6.065	177	EX1571.20.110	171
EX1530.40.300	178	EX1540.32.210	172	EX1571.20.2.050	175
EX1530.40.330	178	EX1540.32.220	172	EX1571.20.6.030	175
EX1530.42.350	179	EX1540.32.230	172	EX1571.21.125	173
EX1530.42.370	179	EX1540.32.255	172	EX1571.21.160	173
EX1530.42.390	179	EX1540.32.4.090	175	EX1571.21.190	173
EX1530.42.420	179	EX1540.32.6.070	175	EX1571.21.205	173
EX1530.48.430	179	EX1540.36.2.150	177	EX1571.21.3.090	176
EX1530.48.450	179	EX1540.36.285	174	EX1571.21.4.070	176
EX1530.48.470	179	EX1540.36.305	174	EX1571.25.125	171
EX1530.48.490	179	EX1540.36.325	174	EX1571.25.160	171
EX1530.50.350	178	EX1540.36.350	174	EX1571.25.190	171
EX1530.50.370	178	EX1540.36.4.100	177	EX1571.25.2.100	175
EX1530.50.390	178	EX1540.40.2.150	175	EX1571.25.205	171
EX1530.50.420	178	EX1540.40.270	172	EX1571.25.3.090	175
EX1530.63.440	178	EX1540.40.285	172	EX1571.25.4.070	175
EX1530.63.460	178	EX1540.40.300	172	EX1571.25.6.060	175
EX1530.63.480	178	EX1540.40.330	172	EX1571.29.210	173
EX1530.63.520	178	EX1540.40.7.090	175	EX1571.29.230	173
EX1540.09.060	174	EX1540.42.350	174	EX1571.29.250	173
EX1540.09.080	174	EX1540.42.370	174	EX1571.29.275	173
EX1540.09.2.030	177	EX1540.42.390	174	EX1571.29.3.090	176
EX1540.09.4.015	177	EX1540.42.4.100	177	EX1571.29.6.065	176
EX1540.11.055	174	EX1540.42.420	174	EX1571.32.210	171
EX1540.11.085	174	EX1540.48.3.180	177	EX1571.32.220	171
EX1540.11.2.050	177	EX1540.48.430	174	EX1571.32.230	171
EX1540.11.3.030	177	EX1540.48.450	174	EX1571.32.255	171
EX1540.13.080	174	EX1540.48.470	174	EX1571.32.4.090	175
EX1540.13.110	174	EX1540.48.490	174	EX1571.32.6.070	175

Art.-No. Art.-No.	Seite Page	Art.-No. Art.-No.	Seite Page	Art.-No. Art.-No.	Seite Page
EX1571.36.2.150	176	EX1801.25	161	EX1803.83.20	168
EX1571.36.285	173	EX1801.29	162	EX1803.83.25	168
EX1571.36.305	173	EX1801.32	161	EX1803.83.32	168
EX1571.36.325	173	EX1801.40	161	EX1803.83.40	168
EX1571.36.350	173	EX1803.07.03.065	160	EX1803.83.50	168
EX1571.36.4.100	176	EX1803.07.03.080	160	EX1803.83.63	168
EX1571.40.2.150	175	EX1803.09	160	EX1811.09	162
EX1571.40.270	171	EX1803.11	160	EX1811.11	162
EX1571.40.285	171	EX1803.12.03.065	159	EX1811.13	162
EX1571.40.300	171	EX1803.12.03.080	159	EX1811.16	162
EX1571.40.330	171	EX1803.13	160	EX1811.17	161
EX1571.40.7.090	175	EX1803.16	160	EX1811.20	161
EX1571.42.350	173	EX1803.17	159	EX1811.21	162
EX1571.42.370	173	EX1803.20	159	EX1811.25	161
EX1571.42.390	173	EX1803.21	160	EX1811.29	162
EX1571.42.4.100	176	EX1803.25	159	EX1811.32	161
EX1571.42.420	173	EX1803.29	160	EX1811.40	161
EX1571.48.3.180	176	EX1803.32	159	EX1813.83.12.065	168
EX1571.48.430	173	EX1803.36	160	EX1813.83.17	168
EX1571.48.450	173	EX1803.40	159	EX1813.83.20	168
EX1571.48.470	173	EX1803.42	160	EX1813.83.25	168
EX1571.48.490	173	EX1803.48	160	EX1813.83.32	168
EX1571.48.6.120	176	EX1803.50	159	EX1813.83.40	168
EX1571.50.350	171	EX1803.63	159	EX1813.83.50	168
EX1571.50.370	171	EX1803.80.07.060	167	EX1813.83.63	168
EX1571.50.390	171	EX1803.80.07.075	167	EX1826.17.070	150
EX1571.50.4.100	175	EX1803.80.09.080	167	EX1826.17.100	150
EX1571.50.420	171	EX1803.80.09.100	167	EX1826.20.110	150
EX1571.63.3.180	175	EX1803.80.11.085	167	EX1826.20.140	150
EX1571.63.440	171	EX1803.80.11.120	167	EX1826.25.150	150
EX1571.63.460	171	EX1803.80.12.060	166	EX1826.25.180	150
EX1571.63.480	171	EX1803.80.12.075	166	EX1826.32.230	150
EX1571.63.520	171	EX1803.80.13.110	167	EX1826.32.260	150
EX1571.63.6.120	175	EX1803.80.13.140	167	EX1826.40.260	150
EX1700.12.10.065	169	EX1803.80.16.110	167	EX1826.40.320	150
EX1700.17.14.060	169	EX1803.80.16.140	167	EX1826.50.360	150
EX1700.17.14.080	169	EX1803.80.17.080	166	EX1826.50.420	150
EX1700.17.14.105	169	EX1803.80.17.100	166	EX1826.63.440	150
EX1700.20.17.080	169	EX1803.80.20.110	166	EX1826.63.500	150
EX1700.20.17.110	169	EX1803.80.20.140	166	EX2450.12.34	170
EX1700.20.19.080	169	EX1803.80.21.160	167	EX2450.17.34	170
EX1700.20.19.110	169	EX1803.80.21.190	167	EX2450.20.34	170
EX1700.20.19.150	169	EX1803.80.25.160	166	EX3500.07.08	181
EX1700.20.21.080	169	EX1803.80.25.190	166	EX3500.07.10	181
EX1700.20.21.110	169	EX1803.80.29.230	167	EX3500.09.08	181
EX1700.20.21.150	169	EX1803.80.29.255	167	EX3500.09.10	181
EX1700.25.21.125	169	EX1803.80.32.210	166	EX3500.09.12	181
EX1700.25.21.160	169	EX1803.80.32.250	166	EX3500.10.08	180
EX1700.25.27.125	169	EX1803.80.36.305	167	EX3500.11.08	181
EX1700.25.27.160	169	EX1803.80.36.350	167	EX3500.11.10	181
EX1700.25.27.205	169	EX1803.80.40.285	166	EX3500.11.12	181
EX1700.32.27.210	169	EX1803.80.40.320	166	EX3500.11.17	181
EX1700.40.36.285	169	EX1803.80.42.370	167	EX3500.12.08	180
EX1700.50.45.370	169	EX1803.80.42.410	167	EX3500.12.10	180
EX1700.63.56.460	169	EX1803.80.48.430	167	EX3500.13.12	181
EX1801.09	162	EX1803.80.48.465	167	EX3500.13.17	181
EX1801.11	162	EX1803.80.50.370	166	EX3500.16.12	181
EX1801.13	162	EX1803.80.50.410	166	EX3500.16.17	181
EX1801.16	162	EX1803.80.63.460	166	EX3500.16.20	181
EX1801.17	161	EX1803.80.63.500	166	EX3500.17.10	180
EX1801.20	161	EX1803.83.12.065	168	EX3500.17.12	180
EX1801.21	162	EX1803.83.17	168	EX3500.20.12	180

Art.-No. Art.-No.	Seite Page	Art.-No. Art.-No.	Seite Page	Art.-No. Art.-No.	Seite Page
EX3500.20.17	180	EX8729.08	184	F1000.63.85.440	139
EX3500.21.17	181	EX8732.08	184	F1000.75	128
EX3500.21.20	181	EX8736.08	184	F1000.75.500	127
EX3500.21.25	181	EX8740.08	184	F1000.75.560	127
EX3500.25.17	180	EX8748.08	184	F1000.75.630	127
EX3500.25.20	180	EX8750.08	184	F1060.06.025	126
EX3500.29.25	181	EX8763.08	184	F1060.06.030	126
EX3500.29.32	181	F...		F1060.08.030	126
EX3500.32.20	180	F1000.06.025	127	F1060.08.040	126
EX3500.32.25	180	F1000.06.030	127	F1060.08.52.030	134
EX3500.36.32	181	F1000.06.035	127	F1060.08.52.040	134
EX3500.36.40	181	F1000.08.035	127	F1060.10.040	126
EX3500.40.25	180	F1000.08.050	127	F1060.10.060	126
EX3500.40.32	180	F1000.10.040	127	F1060.10.52.040	134
EX3500.42.32	181	F1000.10.060	127	F1060.10.52.060	134
EX3500.42.40	181	F1000.12.050	127	F1060.12.050	126
EX3500.42.50	181	F1000.12.065	127	F1060.12.065	126
EX3500.48.40	181	F1000.12.080	127	F1060.12.075	126
EX3500.48.50	181	F1000.17	128	F1060.12.52.050	134
EX3500.50.32	180	F1000.17.045	127	F1060.12.52.065	134
EX3500.50.40	180	F1000.17.060	127	F1060.12.52.075	134
EX3500.63.40	180	F1000.17.080	127	F1060.17	126
EX3500.63.50	180	F1000.17.105	127	F1060.17.060	126
EX3600.07.12	183	F1000.17.85.045	139	F1060.17.080	126
EX3600.07.17	183	F1000.17.85.080	139	F1060.17.105	126
EX3600.08.10	182	F1000.17.85.100	139	F1060.17.52.060	134
EX3600.09.17	183	F1000.20	128	F1060.17.52.080	134
EX3600.09.20	183	F1000.20.080	127	F1060.17.52.105	134
EX3600.10.12	182	F1000.20.110	127	F1060.20	126
EX3600.11.20	183	F1000.20.150	127	F1060.20.080	126
EX3600.11.25	183	F1000.20.85.120	139	F1060.20.110	126
EX3600.12.17	182	F1000.20.85.140	139	F1060.20.145	126
EX3600.13.20	183	F1000.25	128	F1060.20.52.080	134
EX3600.13.25	183	F1000.25.125	127	F1060.20.52.110	134
EX3600.16.25	183	F1000.25.160	127	F1060.20.52.145	134
EX3600.16.32	183	F1000.25.205	127	F1060.25	126
EX3600.17.20	182	F1000.25.85.160	139	F1060.25.125	126
EX3600.20.25	182	F1000.25.85.190	139	F1060.25.160	126
EX3600.21.32	183	F1000.32	128	F1060.25.190	126
EX3600.21.40	183	F1000.32.170	127	F1060.25.52.125	134
EX3600.25.32	182	F1000.32.210	127	F1060.25.52.160	134
EX3600.29.40	183	F1000.32.255	127	F1060.25.52.190	134
EX3600.29.50	183	F1000.32.85.220	139	F1060.32	126
EX3600.32.40	182	F1000.32.85.250	139	F1060.32.210	126
EX3600.36.50	183	F1000.4.20	70	F1060.32.255	126
EX3600.36.63	183	F1000.4.25	70	F1060.32.52.210	134
EX3600.40.50	182	F1000.4.32	70	F1060.32.52.245	134
EX3600.42.63	183	F1000.40	128	F1060.40	126
EX3600.48.63	183	F1000.40.240	127	F1060.40.285	126
EX3600.50.63	182	F1000.40.285	127	F1060.40.330	126
EX8707.08	184	F1000.40.330	127	F1060.50	126
EX8708.08	184	F1000.40.85.300	139	F1060.50.370	126
EX8709.08	184	F1000.50	128	F1060.50.420	126
EX8710.08	184	F1000.50.330	127	F1060.63	126
EX8711.08	184	F1000.50.370	127	F1060.63.460	126
EX8712.08	184	F1000.50.420	127	F1060.63.520	126
EX8713.08	184	F1000.50.85.380	139	F1060.75	126
EX8716.08	184	F1000.63	128	F1060.75.560	126
EX8717.08	184	F1000.63.400	127	F1060.75.630	126
EX8720.08	184	F1000.63.460	127	F1083.12.050	136
EX8721.08	184	F1000.63.520	127	F1083.12.065	136
EX8725.08	184	F1000.63.85.380	139	F1083.17	136

Art.-No. Art.-No.	Seite Page	Art.-No. Art.-No.	Seite Page	Art.-No. Art.-No.	Seite Page
F1083.20	136	F1160.06.025	129	F1310.32.2.115	132
F1083.25	136	F1160.06.030	129	F1310.32.3.090	132
F1083.32	136	F1160.08.030	129	F1310.32.3.105	132
F1083.40	136	F1160.08.040	129	F1310.32.4.090	132
F1083.50	136	F1160.10.040	129	F1310.32.6.070	132
F1083.63	136	F1160.10.060	129	F1311.17.2.030	133
F1084.17	137	F1160.12.050	129	F1311.17.2.040	133
F1084.20	137	F1160.12.065	129	F1311.17.2.050	133
F1084.25	137	F1160.12.075	129	F1311.20.2.050	133
F1084.32	137	F1160.17	129	F1311.20.2.060	133
F1084.40	137	F1160.17.105	129	F1311.20.2.075	133
F1084.50	137	F1160.20	129	F1311.20.3.050	133
F1084.63	137	F1160.20.145	129	F1311.20.3.060	133
F1084.75	137	F1160.25	129	F1311.20.3.065	133
F1084.80.650	137	F1160.25.190	129	F1311.20.4.050	133
F1084.85.700	137	F1160.32	129	F1311.20.4.060	133
F1100.06.025	130	F1160.32.255	129	F1311.25.2.070	133
F1100.06.030	130	F1160.40	129	F1311.25.2.090	133
F1100.06.035	130	F1160.40.330	129	F1311.25.2.100	133
F1100.08.035	130	F1160.50	129	F1311.25.3.070	133
F1100.08.050	130	F1160.50.420	129	F1311.25.3.090	133
F1100.10.040	130	F1160.63	129	F1311.25.4.070	133
F1100.10.060	130	F1160.63.520	129	F1311.25.6.060	133
F1100.12.050	130	F1160.75	129	F1311.32.2.115	133
F1100.12.065	130	F1160.75.630	129	F1311.32.3.090	133
F1100.12.080	130	F1183.12.050	136	F1311.32.3.105	133
F1100.17	131	F1183.12.065	136	F1311.32.4.090	133
F1100.17.045	130	F1183.17	136	F1311.32.6.070	133
F1100.17.060	130	F1183.20	136	F1800.10.03.040	135
F1100.17.080	130	F1183.25	136	F1800.10.03.060	135
F1100.17.105	130	F1183.32	136	F1800.12.03.065	135
F1100.20	131	F1183.40	136	F1800.12.03.080	135
F1100.20.080	130	F1183.50	136	F1800.17.03.105	135
F1100.20.110	130	F1183.63	136	F1800.20.03.150	135
F1100.20.150	130	F1184.17	138	F1800.25.03.205	135
F1100.25	131	F1184.20	138	F1800.32.03.255	135
F1100.25.125	130	F1184.25	138	F1800.40.03.330	135
F1100.25.160	130	F1184.32	138	F1800.50.03.410	135
F1100.25.205	130	F1184.40	138	F1800.63.03.520	135
F1100.32	131	F1184.50	138	F1800.75.03.630	135
F1100.32.170	130	F1184.63	138	W...	
F1100.32.210	130	F1184.75	138	W1100.12.95.050	66
F1100.32.255	130	F1184.80.650	138	W1100.12.95.065	66
F1100.4.20	70	F1184.85.700	138	W1100.12.95.080	66
F1100.4.25	70	F1310.17.2.030	132	W1100.17.95.105	66
F1100.4.32	70	F1310.17.2.040	132	W1100.20.95.150	66
F1100.40	131	F1310.17.2.050	132	W1100.25.95.205	66
F1100.40.240	130	F1310.20.2.050	132	W1100.32.95.255	66
F1100.40.285	130	F1310.20.2.060	132	W1100.40.95.330	66
F1100.40.330	130	F1310.20.2.075	132		
F1100.50	131	F1310.20.3.050	132		
F1100.50.330	130	F1310.20.3.060	132		
F1100.50.370	130	F1310.20.3.065	132		
F1100.50.420	130	F1310.20.4.050	132		
F1100.63	131	F1310.20.4.060	132		
F1100.63.400	130	F1310.25.2.070	132		
F1100.63.460	130	F1310.25.2.090	132		
F1100.63.520	130	F1310.25.2.100	132		
F1100.75	131	F1310.25.3.070	132		
F1100.75.500	130	F1310.25.3.090	132		
F1100.75.560	130	F1310.25.4.070	132		
F1100.75.630	130	F1310.25.6.060	132		

Anfrage für eine Speziallösung Enquiry for a special solution

Kunden Nr.: Customer No.:	Ansprechpartner: Contact:
Jahresbedarf Menge / Stk.: Annual required volume / pieces:	Rahmen / Laufzeit: Scope / timeframe:
Preisvorstellung: Pricing expectations:		

Abmessungen Kabelverschraubung Cable gland dimensions

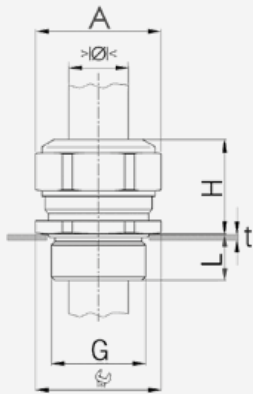

$\varnothing A$	Aussendurchmesser Rosette Outside diameter of rosette	mm
G	Anschlussgewinde Entry thread	mm
H	Zielhöhe des Bauteils Target height of component	mm
L	max. Auftrag in Gerät Max. protrusion in equipment	mm
t	Blechdicke Sheet metal thickness	mm
	Schlüsselweite Spanner jaw gap	mm
$\varnothing \text{K}$	Kabelklemmbereich Cable clamping range	mm

<input type="checkbox"/> Basis Standard Standard basis	<input type="checkbox"/> Für Innenmontage For interior assembly
---	--

Materialanforderungen Gehäuse Material requirements: enclosure

<input type="checkbox"/> Messing vernickelt (Standard) Nickel-plated brass (standard)	<input type="checkbox"/> Rostfreier Stahl A2 Stainless steel A2
<input type="checkbox"/> Säurebeständiger Stahl A4 Acid-resistant stainless steel A4	<input type="checkbox"/> Andere Others

Materialanforderungen Dichteinsatz Material requirements: sealing insert

<input type="checkbox"/> TPE TPE	<input type="checkbox"/> NBR NBR
<input type="checkbox"/> FPM FPM	<input type="checkbox"/> Multi-Dichteinsatz Multi sealing insert
<input type="checkbox"/> Mit Schlauchanbindung With conduit connection	<input type="checkbox"/> Andere Others

Besondere Bedingungen Special conditions

<input type="checkbox"/> Einsatzgebiet: z.B. Lebensmittel, Pharma, Bahn etc. Where used: e.g. foodstuffs, pharmaceuticals, railway
<input type="checkbox"/> IP-Schutzgrad / Druck / Zeit IP protection class rating / pressure / time / /
<input type="checkbox"/> Temperaturbereich Temperature range - °C + °C
<input type="checkbox"/> Medienbeständigkeit / gasförmig / flüssig Resistance to chemical substances / gaseous / fluid
<input type="checkbox"/> Strahlungsbeständigkeit Radiation resistance
<input type="checkbox"/> Ex-Anforderungen (Einsatz Ex i, Ex e II, Ex d II C) Hazardous area requirements (Ex i, Ex e II, Ex d II C)
<input type="checkbox"/> EMV EMC
<input type="checkbox"/> Normative Anforderungen Requirements from standards

Systeme und Lösungen für die professionelle Installation.

Systems and solutions for the professional electrical installation.



Kabelschutzschläuche.

Produkte für Anwendungen im Maschinen-, Anlagen-, Fahrzeug- und Schienenfahrzeugbau, der Automation oder Energietechnik.

Protective cable conduits.

Products for applications in mechanical engineering, facilities construction, automobile and rolling stock manufacture, automation and energy engineering.



E-Mobility.

EVolution EMC Kabelverschraubung – Geschaffen für die anspruchsvolle Elektromobilität.

E-Mobility.

The EVolution EMC cable gland – developed for the most demanding electromobility applications.



Elektro-Installation.

Systeme und Lösungen für die professionelle Elektro-Installation in Unterputz-/Mauerwerk-, Hohlwand- und Betonbauweise.

Electrical Installation.

Systems and solutions for professional electrical installation work with flush-mounting/masonry/cavity wall and concrete constructions.

Alle weiterführenden Informationen zu Produkten, Systemlösungen und Kommunikationsmedien finden Sie aktuell auf: www.agro.ch.

Please find additional information about products, system solutions and communication media on: www.agro.ch.

AGRO AG | Member of KAISER GROUP

Korbackerweg 7 · 5502 Hunzenschwil
SCHWEIZ

Tel. +41(0)62 889 47 47 · Fax +41(0)62 889 47 50

www.agro.ch · info@agro.ch

