

Westec®



**Multipole Industrial Connectors
Aluminium Enclosures
Cable Glands and Fittings**

Compact Catalogue

THE COMPANY

Westec represent the new Italian challenge in the market of Multipole Connectors for Industrial applications. A challenge born from 30 years experience in the designing and in the manufacturing of connectors for electric and electronic devices that pushes Westec in the continuous research for the achievement of new quality levels for the technical and operational aspects of its connectors. The constant industrial developments focusing on both the designing and the manufacturing, allowed Westec to make one of the best ranges of Multipole Connectors for industrial applications, introduced to the market with GWconnect brand.

The product range offers the ultimate value for money

- Certified in accordance with the latest European and American Standards by the most qualified independent laboratories in Italy.
- Accurately designed even for appearances' sake, to guarantee the excellence under any point of view.
- A complete series of aluminium junction boxes together with a good range of metal and plastic cable glands, join the heavy duty connectors to complete the offer and to render the purchasing process simpler and more efficient.

Direct link with the client

- Continuous collaboration with our customers allows us to obtain cohesive feedback on market needs and current demands. We utilize all feedback gained and use the information to develop new, innovative and competent solutions in compliance with the Standards.
- Establishing a more personal relationship with clients allows us to offer a more transparent service where we can provide prompt responses on both technical and commercial enquiries.

An efficient and flexible internal organization

- The Italy base headquarter with its well-stocked warehouse, can supply efficiently the worldwide sales network.
- A flexible design approach allows Westec to manufacture special OEM solutions on customers' demand.
- A wide distribution network is available. Pls contact us at: info@westec.it to know your nearest distributor.

Westec®

Multipole Industrial Connectors Aluminium enclosures - Cable glands and fittings

Compact catalogue

For more technical details, specifications
and special products please consult the
Westec General Catalogue



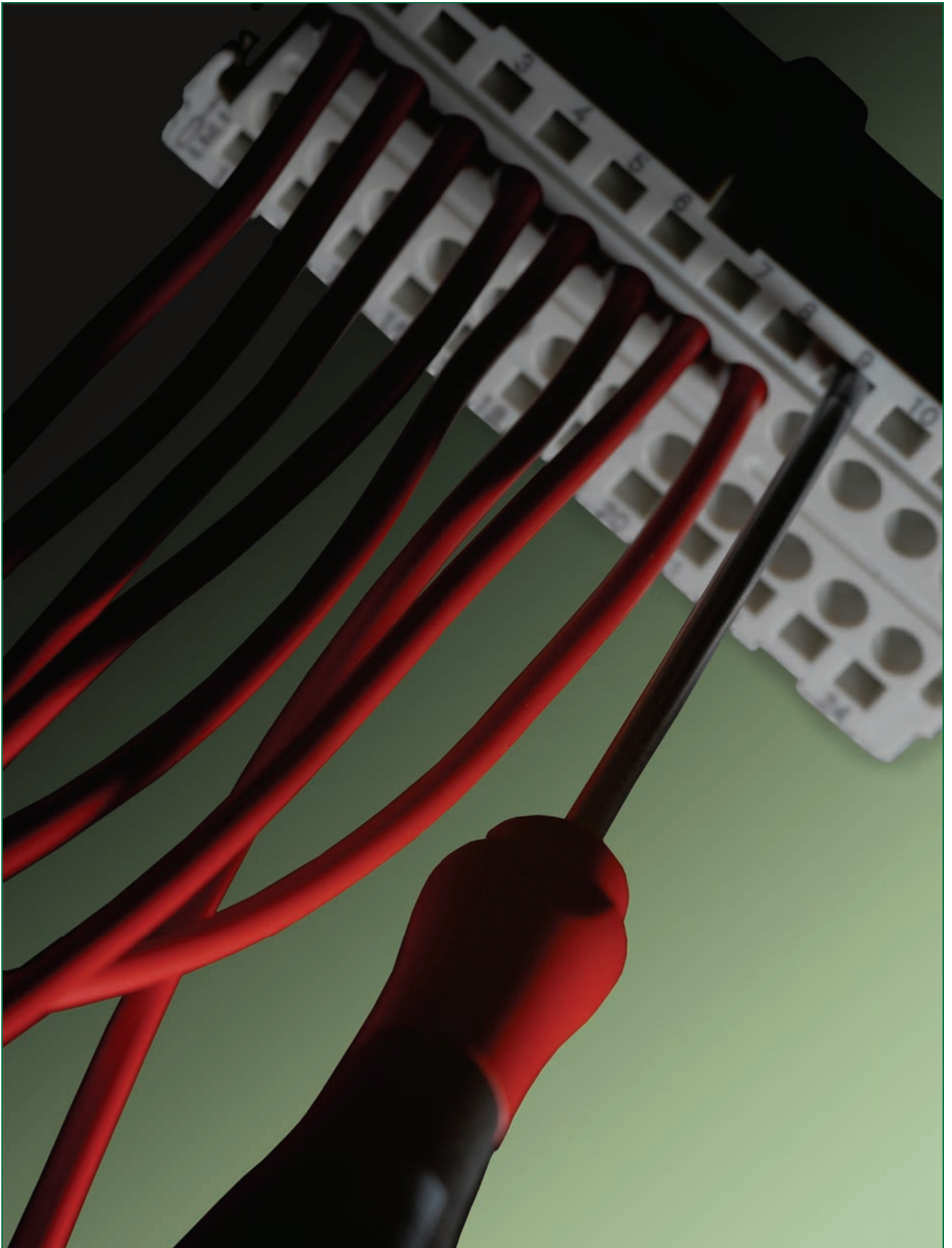

Contents	Pages
Technical characteristics	2 - 9
S-A series - size 3A «21x21» 10A 230/400V/4kV/3 and size 10A, 16A, 32A, 16A 250V/4kV/3 inserts	10
S-E series - S-EE high density, S-ES series - 16A 500V/6kV/3 inserts, with screw, crimp and spring terminals	10 - 12
S-EAV series - 16A 500V/6kV/3 inserts with screw terminal block	12 - 13
S-EHV, S-ESHV series - 16A 830V/8kV/3 inserts, with screw, crimp and spring terminals	13 - 14
S-HSB series - 35A 830V/6kV/3 inserts	14
S-D series - 10A 250V/4kV/3 inserts, with crimp terminals	15
S-DD series - 10A 250V/4kV/3 high density inserts, with crimp terminals	15
S-K series - 80A + 16A 500V/6kV/3 and 830V/8kV/3 inserts	16
S-Q series - size 3A «21x21», 5p 16A and 12p 10A inserts - S-QD series, size «32x13» inserts	16
S-EP series - 16A 500V/6kV/3 Push-In inserts	17
Crimp type contacts for inserts	18 - 19
Hoods/housings size «21x21»	21
Hoods/housings size «32x13» STD, HE	22
Hoods/housings size 10A «49x16», 16A «66x16», 32A «66x40»	23 - 25
Hoods/housings size B single or double locking system for inserts up to 500V	26 - 35
Hoods/housings size B reversed locking system for inserts up to 500V	35 - 37
GWconnect ports: Power and data connecting interfaces	38 - 40
Industrial Ethernet: connectors and cables	41
Cable glands, fittings and accessories	42 - 46
Accessories and supports for multipolar industrial connectors	47 - 49
Insulated bush terminals	50 - 51
Tools	52 - 53
Aluminium boxes	54 - 71
Part numbers index	72

For more technical details please consult the Westec General Catalogue

General characteristics

The multipole connectors for industrial purposes are used in electric and electronic machinery, robots, electric panels, control equipments and wherever connections are required for power, control and signal circuits.
The connectors are designed for heavy-duty industrial applications. They are suitable for use with alternate or direct current and facilitate the manufacturing process, installation and maintenance of sectional electric parts in complex machinery in accordance with European Standard EN 60204-1

Referring standards:

- EN 61984:** Connectors safety requirements and tests
- VDE 0627:** Connectors (DIN VDE 0627)
- EN 60664-1:** Insulation coordination for equipment within low-voltage systems
- VDE 0110:** Table 4 concerning clearance and creepage distances
- EN 175 301-801:** High density rectangular connectors, round removable crimp contacts
- EN 60947-7-1:** Low-voltage switchgear and controlgear. Ancillary equipments - Terminal blocks for copper conductors
- EN 60512:** Connectors for electronic equipments. Tests and measurements
- UL 1977:** Component connectors for use in data, signal, control and power applications
- CSA: C22.2 No.182.3:** Special use attachment, plugs, receptacles and connectors
- EN 60423:** Conduits for electrical purposes. Outside diameters of conduits for electrical installations and thread for conduits and fittings
- EN 50262:** Metric cable glands for electrical installation
- EN 60529:** Degree of protection provided by enclosures (IP degree)
- NEMA 250:** National (USA) Electrical Manufacturers Association. Class (Type) of protection.
- ANSI/UL 50:** Enclosures for electrical equipment, non environmental consideration
- ANSI/UL 50E:** Enclosures for electrical equipment, environmental consideration
- CSA C22.2 No.94-1-2:** Special purpose enclosures.
- NMX-J235/1-2:** ANCE: Association of Standardization and Certification (USA) Special purpose enclosures

- DIN 40050-9 / ISO 20653:** Electrical equipments in road vehicles. Enclosures. Water test with high pressure. IP69K.
- NEMA ICS5:** Food and beverage industries. High pressure power wash test procedure for self contained control-circuit devices.

Connectors compliant with DESINA® standard

DESINA® (Distributed and Standardized INstAllation technology) is an innovative installation system studied by the German manufacturers of machine tools association (VDW), with the cooperation of users (including German automotive manufacturers) and component manufacturers, which has led to the introduction of a specification aimed to standardize electrical, hydraulic and pneumatic components and their interconnection on common platform for CNC controlled machine tools and manufacturing lines.
The DESINA® specification has been enclosed into ISO TC 184/SC1 "Industrial automation systems and integration / Physical device control" as an ISO standard.

The ISO standards are the following:

- ISO 23570-1:** Industrial automation systems and integration - Distributed installation in industrial applications:
Part 1 - Sensors and actuators.
- ISO 23570-2:** Industrial automation system and integration. Distributed installation in industrial applications.
Part 2: Hybrid communication bus
- ISO 23570-3:** Industrial automation system and integration. Distributed installation in industrial applications.
Part 3: Power distribution bus

DESINA® specifications



EUROMAP recommendations:

The inserts and the relevant enclosures meet the EUROMAP Recommendations (European Committee of machinery manufacturers for the plastic and rubber industry)
EUROMAP 12, 13, 14, 16, 67, 67.1, 71

Approvals: UL, CSA File E249674

The connectors are designed and manufactured to conform with EN 61984, EN 175 301-801, UL 1977 and CSA C22.2 182.3 standards.

The enclosures are designed in conformance with UL 50, UL 50 E and CSA C22.2 No. 94-1-2
Inserts and enclosures are certified and labelled with the UL and CSA marks: file E249674

The Westec connectors are therefore in conformance with both European/International and American system.
This permits them to be used in a wider range of applications worldwide.



General characteristics

Inserts:

The inserts are made of self-extinguishing thermoplastic resin UL 94 V0, GWT 960°, normally used in maximum temperature of 125°C. The inserts are available in screw, spring, crimp and screw form with terminal block connections. The contacts are in silver or gold plated copper alloy. All are numbered on both sides by laser printing or molding in accordance with EN 60068-2-70.

- Suitable for use with alternate or direct current
- Leading protective ground
- Polarized for correct mating
- Interchangeable for male and female inserts in hoods and housings
- Captive screws
- Can be used with hoods and housings, or with rack and panel applications.

Conductors connection, termination:

- Screw terminals
- Crimp terminals
- Screw terminals with terminal block
- Spring terminals

Enclosures:

A large variety of enclosures is available with different combination of components and materials, each one suitable to a specific industrial installation for normal environmental conditions and aggressive environments.

The principal parts are made in die-cast aluminium alloy with a finishing of polyester powder (Natural aluminium for EMC version) or in self extinguishing thermoplastic. They are resistant to impact and strong mechanical stress. Coupling stability and protection against accidental opening are assured by a single or double locking system, comprising of monoblock levers in galvanized steel or stainless steel, springs and pegs in stainless-steel or plastic.

Sealing is assured by special gaskets that protect the inserts inside the enclosures against dust, water and other aggressive agents.

- Innovative design
- Hoods/housings for normal environmental conditions and EMC
- Hoods/housings for harsh environmental requirements
- Degree of protection according to EN 60529: IP66 / IP67 / IP69K
- Degree of protection according to ANSI/UL50, 50E, NEMA 250 Type 4/4x/12
- Electrical connection with protective ground
- High mechanical strength and vibration resistance ensured by locking levers
- Spring-loaded lockable metal covers

Cable glands, fittings and accessories:

- Extensive range of cable protection and sealing accessories
- Metal cable glands IP65/IP66
- Plastic cable glands IP66
- Metal cable glands IP68
- Plastic cable glands IP68
- Fittings for flexible conduits
- Hexagonal nuts
- Enlargers/reducers
- Code pins for incorrect mating protection

Tools:

To guarantee the efficiency and security of the connection and to ensure that maximum quality standards are met, a complete series of application specific tooling is available for contact crimping and cable assembling

Metal Boxes:

A wide range of aluminium boxes with protection are offered as a solution to a wide range of installations, such as circuit breaking, connection and control of electric and electronic equipments.

Design and testing:

The connectors and the other products of this series have been designed and tested in Italy to meet the exact electrical and environmental standards set down within industry guidelines

CE Marking:

In accordance with Low Voltage Device (LVD) Directive 2006/95/EC

RoHS Compliance:

The products are in accordance with the European Directive 2002/95/EC and its amendments Directive 2008/35/EC on the use of certain hazardous substances in electrical and electronic equipments (RoHS)

EMC Compliance:

The hoods/housings EMC type are in conformity with European Directive 2004/108/CE (EMC = Electromagnetic Compatibility)

Technical support:

For any question and technical support please contact your nearest dealer or contact us directly at : info@westec.it

Remarks:

It is the users responsibility to ensure that products of this catalogue comply with regulations other than those stated when used in special fields of applications which we are unable to foresee, and that are assembled and installed correctly, in accordance with the installation Standards.

Westec Srl is not responsible for the installation result and/or in case of incorrect use of the products supplied.

Connectors should not be coupled and de-coupled under electrical load.

For spring terminal inserts, the correct cable assembly is assured only by using the correct screwdriver shown on the catalogue.

For screw terminal inserts is necessary to apply the correct torque in order to avoid false contacts or damages to the conductor, to the screw end to the contact itself.

Westec guarantee the IP degree of the Aluminium boxes as shown on the catalogue and manufactured, without holes and other milling operations. It is the users responsibility to verify the maximum number of holes for the cable entries, that must be in conformance with the specific application, as well as the type and size of cable glands, blanking plugs and/or other fittings that must have an equivalent or higher IP degree than the one of the junction box.

In the interest of development and improvement we reserve the right to amend, without notice, details contained in this publication.

No legal liability will be accepted by Westec for any errors, omissions or amendments.

This catalogue must not be used or reproduced in any form or manner without our prior approval in writing.



The shape of performance

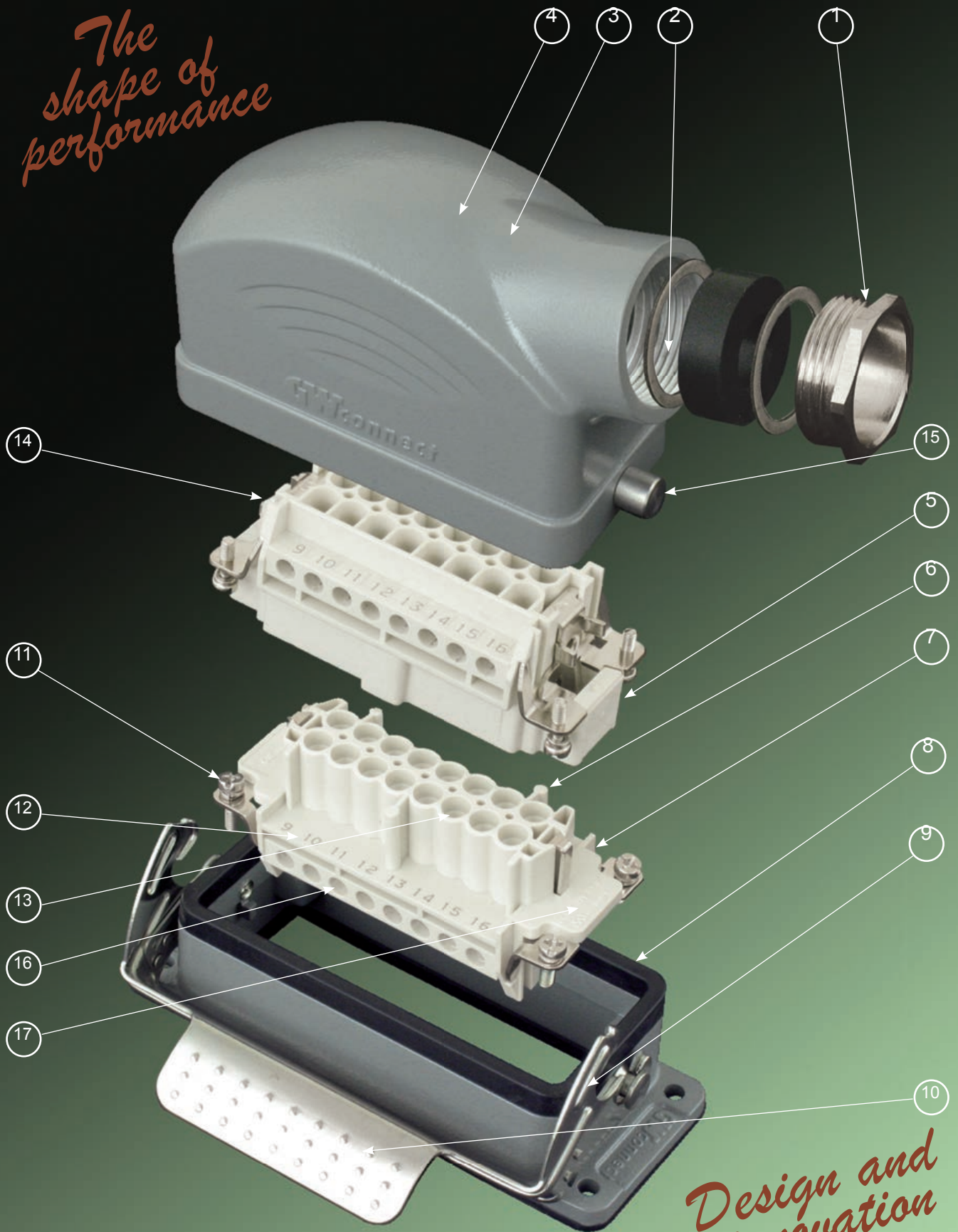

Design and innovation

Technical features

- 1) A wide range of accessories comprising of: cable glands, fittings for flexible conduits, blanking plugs, enlargers, reducers and lock units.
- 2) Threaded cable passage in various Pg and metric thread (in accordance with EN 60423) available, for cable entry devices in accordance with EN 50262, as option located vertically, horizontally or at the front. NPT threads on request.
- 3) Heavy duty enclosures in die-cast aluminium alloy or self-extinguishing thermoplastic. Surface mounting or bulkhead housings and hoods are available, with or without fixed covers or with mobile protection covers. The enclosures for the use at a voltage of 500V have two tabs that prevents the insertion of inserts for the use with 830V. Those for the use with a rated voltage of 830V do not have any tabs and supplementary insulating strips are applied.
- 4) Metal enclosures powder coated with high resistance to mechanical stress and external agents, Enclosures used for harsh environments are treated with special polyester powder coating. Certified UL/CSA.
- 5) Insert in self-extinguishing thermoplastic material reinforced with glass fibres, UL approved, with a limit working temperature from -40°C to +125°C.
- 6) Inserts with asymmetric guide rails for preventing incorrect coupling. The inserts have a mechanical duration equal to or over 500 mating / unmating cycles.
- 7) Inserts manufactured to conform with EN 61984, VDE 0110, VDE 0627, EN 175301-801, UL 1977 standards. They are certified and labelled with the UL and CSA marks.
- 8) Special seal gaskets in anti-ageing, oil-resistant and fuel resistant vinyl nitrile elastomer or fluoro elastomer (for use in harsh environments) together with the joints provide an IP66 degree of protection for coupled connectors.
- 9) Monoblock galvanized steel or stainless steel or self-extinguishing glass filled thermoplastic material locking levers guarantee a perfect closure and sealing.
- 10) Locking device available in two versions, simple (with one lever) or double (with two levers).
- 11) Captive insert fastening screws, with anti-loosening flexible washer.
- 12) Contacts position identified with numbers on both sides of each insert, laser printed or moulded.
- 13) Contacts in silver or gold-plated copper alloy with connection to the conductors made via captive screws, crimping terminals, spring terminals or screws with incorporated terminal block.
- 14) Earth terminal with wide contact surface.
- 15) Stainless steel pegs that facilitate the locking and eliminate damages.
- 16) Captive contact screws, stainless steel wire protector.
- 17) CE marking attesting the conformity to the requirements of the Directive Low Voltage Device (LVD) 2006/95/EC and of the Directive EMC 2004/108/EC for the products developed for industrial applications that require Electromagnetic Compatibility (EMC).

Size and identification of enclosures and inserts

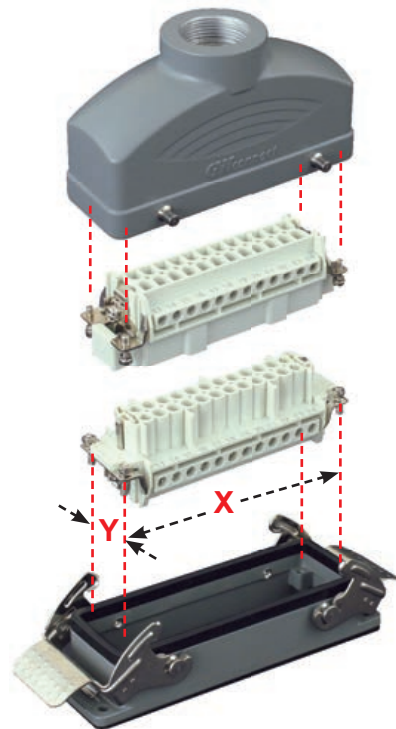

Size and identification of the enclosures and inserts

There are a large number of connector inserts and their relative enclosures so the selection of a correct combination may be complex. To facilitate this operation as well as the normal item/part No., a further identification parameter has been introduced: the "size" value. The "size" value refers to the screw fixing centre distances which constitute a unique element since they are common to both the inserts and enclosures. This is as indicated in the above illustration and the table below. The following table shows all the sizes of the enclosures and the dimensions of the housings where the inserts will be assembled.

Type	Enclosure «Size» identification	Housing space for inserts with screw fixing centre distance x-y
3A	«21 x 21»	(21 x 21mm) *
10A	«49x16»	49,5 x 16 mm
16A	«66x16»	66 x 16 mm
32A	«66 x 40»	66 x 16 mm (2 inserts)
6B	«44 x 27»	44 x 27 mm
10B	«57 x 27»	57 x 27 mm
16B	«77 x 27»	77,5 x 27 mm
24B	«104 x 27»	104 x 27 mm
32B	«77 x 62»	77,5 x 27 mm (2 inserts)
48B	«104 x 62»	104 x 27 mm (2 inserts)
QD	«32 x 13»	32,2 x 13,4 mm

* The screw fixing centre distance cannot be given because they only have one screw: «21 x 21» indicates the size of the sectioned insert.

Technical characteristics and applications

The enclosures are designed in conformance with EN61984 and ANSI/UL50, ANSI UL50E and CSA C22.2 No. 94.1-2

- Types available:

- STD :** For standard applications for inserts up to 250V or 500V
- STD-HV :** For standard applications for inserts up to 830V (*)
- HE :** For harsh environmental requirements and inserts up to 250V or 500V (*)
- HE-HV :** For harsh environmental requirements and inserts up to 830V (*)
- EMC:** For applications that require electromagnetic compatibility (EMC), for inserts up to 500V (*)
- (*):** These types are available in the Westec General Catalogue

- Single locking system (1 lever) - Single locking system with central lever
- Double locking system (2 levers) - Reversed locking system
- Metric or Pg thread available for Metric and Pg cable glands IP66 and IP68
- Enclosures with NPT threads are available on request for American market
- For flat cables
- Degree of protection according to EN 60529 for coupled hood/housings with cable glands: IP66/IP67
- Class of protection in accordance to ANSI / UL50E Type 4,4x,12, NEMA 250 Type 4/4x/12
- Water jet with high pressure resistant according ISO20653/DIN40050-9 (IP69K)
- Limiting temperature: - 40°C ÷ + 125 °C
- SC - standard construction: with small dimensions
- HC - high construction: bigger size for wider cable diameter
- Certifications:



Material	STD	STD-HV	HE	HE-HV	EMC
Body	Die cast aluminium alloy - Also in polyamide material for STD type				
Surface	Polyester powder coated		Polyester powder coated		Surface with high conductivity
Color	Grey RAL 7037		Black RAL 9005		Aluminium finishing
Pegs	Stainless steel				
Screws	Stainless steel				
Springs	Stainless steel				
Levers	Galvanized steel or stainless steel		Stainless steel		Galvanized steel or stainless steel
Gaskets	NBR		NBR		Conductive elastomer

Certification in accordance with ANSI/UL50, ANSI/UL50E and NEMA 250

Westec MIC connectors enclosures successfully passed ANSI/UL50, ANSI/UL50E and NEMA 250 Type 4, Type 4x and Type 12 testing at Underwriters Laboratory (UL) under the connector category ECBT2 (USA) and ECBT8 (Canada) .

We can declare that the MIC connectors not only meet the European and the International requirements stated in the EN 61984 which the MIC connectors refer to in general and in particular to IEC/EN60529 regarding the IP degrees of protection of the enclosures, but also meet the requirements of American Standards, ANSI/UL50, ANSI/UL50E and NEMA 250 that defines the type classifications for enclosures and control cabinets.

ANSI: Approved American National Standard

UL: Underwriters Laboratories Inc.

In the US the NEMA Association (National Electrical Manufacturer's Association) is one of the major organizations responsible for writing the national electrical standards and requirements of electrical equipments.

Its membership consist mainly of electrical manufacturers and end users.

The NEMA 250 is the document that defines the Type classification for enclosures in the United States.

The NEMA 250 not only takes in consideration the necessary requirements for the protection of the personnel and against the ingress of objects and water as provided by the IEC/EN60529 Standard but numerous other requirements covered by NEMA Type designations, which go beyond the IEC 60529/IP codes.

That is

- Construction requirements
- Door and cover securement
- Corrosion resistance
- Effects of icing
- Gasket ageing and oil resistance
- Coolant effects

The NEMA 250 defines the Type for the enclosures:

The types are listed in the page 00.47 of Westec General Catalogue.

For this reason, IP code designation cannot be converted to enclosure NEMA 250 type numbers.

Most American customers require enclosures with NEMA, UL or CSA rating.

The MIC connectors of Westec have the advantage of not only meeting the International IP requirements, but also fully meeting the requirements of ANSI/UL50, ANSI/UL50E, NEMA 250 Type 4, Type 4x and Type 12, that is:

Type 4: Enclosures constructed for either indoor or outdoor use to provide a degree of protection to personnel against incidental contact with the enclosed equipment; to provide a degree of protection against falling dirt, rain, sleet, snow, windblown dust, splashing water and hose-directed water; and that will be undamaged by the external formation of ice on the enclosures.

Type 4x: Enclosures constructed for either indoor or outdoor use to provide a degree of protection to personnel against incidental contact with the enclosed equipment; to provide a degree of protection against falling dirt, rain, sleet, snow, windblown dust, splashing water and hose-directed water; and corrosion; and that will be undamaged by the external formation of ice on the enclosures.

Type 12: Enclosures constructed (without knockouts) for indoor use to provide a degree of protection to personnel against incidental contact with the enclosed equipment; to provide a degree of protection against falling dirt, circulating dust, lint, fibers, and flyings; against dripping and light splashing of non-corrosive liquids; and against light splashing and consequent seepage of oil and non-corrosive coolants.

Compliance with NEMA requirements is voluntary.

NEMA does not require enclosures to be tested by qualified evaluators, but the UL Certification assures that the MIC connectors of Westec conform the US requirements, also guarantee the clients/users manufacturers of control cabinets and other electrical equipments the conformity to the NEMA and high rating of their products.

For the above the enclosures for MIC made by Westec can be marked with:



Enclosures applications:

In accordance with the standards and certifications all Westec enclosures are for indoor and outdoor uses: what therefore suggests the use of the polyester from aluminium enclosures STD Standard or HE for harsh environmental requirements?

The users shall consider the following:

polyamide enclosures compared with aluminium enclosures are limited by lower working temperature, high rate of ageing due to light, variation of temperature, sensitivity to the humidity, lower mechanical and impact strength, lower heat dissipation lower resistance and chemical agents.

Either Westec aluminium enclosures STD/STD-HV and HE/HE-HV are designed, manufactured and certified for indoor and outdoor use in accordance the same International Standards and accordingly certified, but the HE/HE-HV enclosures are designed for more severe applications in harsh environments taking in consideration a higher resistance to salt atmosphere, corrosive liquids and higher resistance of the painted surfaces to the impacts of splashing water and hose-direct water even with high pressure.

The EMC enclosures are designed for indoor and outdoor use too, but as the aluminium surfaces is not painted, though protected by special galvanic treatment, they shall be used in not particularly aggressive environments.

Enclosures Part No.	Cable glands for enclosures
<p>To facilitate the identification of the several versions of the enclosures, some digits of the part No. have a meaning in accordance with the following rules:</p> <p>Part No.:</p> <p>78XX.ABCD.Y</p> <p>78: Indicates the enclosures</p> <p>XX: Indicates the size in accordance with the following</p> <p>XX = 03 Size 3A «21x21»</p> <p>XX = 06 Size 6B «44x27»</p> <p>XX = 10 Size 10A «49x16» and 10B «57x27»</p> <p>XX = 13 Size QD «32x13»</p> <p>XX = 16 Size 16A «66x16» and 16B «77x27»</p> <p>XX = 24 Size 24B «104x27»</p> <p>XX = 32 Size 32A «66x40» and 32B «77x62»</p> <p>XX = 48 Size 48B «104x62»</p> <p>ABCD: serial number without any particular meaning</p> <p>Y: Indicates the version in accordance the following</p> <p>Y = 0 STD series</p> <p>Y = 1 HE series</p> <p>Y = 2 STD - HV series for 830V inserts</p> <p>Y = 3 HE - HV series for 830V inserts</p> <p>Y = 4 EMC series</p> <p>Y = 5 Hoods STD series without threaded fitting</p> <p>Y = 6 Hoods HE series without threaded fitting</p> <p>Y = 7 Hoods STD - HV series for 830V inserts without threaded fittings</p> <p>Y = 8 Hoods HE-HV series for 830V inserts without threaded fittings</p> <p>Y = 9 Hoods EMC without threaded fitting</p> <p>Y = A, B, etc Special types</p> <p>Note:</p> <p>Part No. bold letters refer to standard availability. Normal letters refer to items on special request.</p>	<p>The cable glands on the enclosures are used to protect and lock the cables with the enclosures ensuring the IP protection of the assembling connectors, enclosures, cable gland.</p> <p>Westec suggest the use of aluminium enclosures with metal cable glands only because these glands only can guarantee the performances of the enclosures: with metal cable glands we can reach the maximum mechanical resistance at pulling, shocks and vibration at the maximum rated temperature (+125°C).</p> <p>The polyester cable glands, can be used only in light environmental conditions and with lower temperature and mechanical strength.</p> <p>We recommend to use the IP68 metal cable gland with big size cable, because they can offer the biggest resistance at mechanical strength like side pulling and cycle movement, guaranteeing the IP degree of protection.</p> <p>Taking head of the above warnings, it's the user responsibility to select the right cable gland from the following series available:</p> <ul style="list-style-type: none"> - IP66 polyamide cable glands - IP66 metal cable glands - IP68 polyamide cable glands - IP68 metal cable glands <p>(please see Westerc General Catalogue)</p> <p>With HC high construction enclosures the using of metal cable glands IP68 is the best solution.</p> <p>Westec offers a wide range of enclosures with a wide range of both threadings Metric and Pg in accordance with market and customers requirements.</p> <p>For coupling with tubes and fittings with NPT thread Westec offers a range of adapters Metric - NPT and Pg - NPT.</p> <p>(please see Westerc General Catalogue)</p> <div style="display: flex; justify-content: space-around;"> <div data-bbox="858 1496 1133 1523"> <p>IP66 polyamide cable glands</p>  </div> <div data-bbox="1204 1496 1412 1523"> <p>IP66 metal cable glands</p>  </div> </div> <div style="display: flex; justify-content: space-around; margin-top: 20px;"> <div data-bbox="858 1736 1133 1762"> <p>IP68 polyamide cable glands</p>  </div> <div data-bbox="1189 1736 1428 1762"> <p>IP68 metal cable glands</p>  </div> </div>

Electrical data for connectors are specified as per EN 61984.

This example identifies a connector suitable for use in an unearthed power systems or earthed delta circuit

This example identifies a connector suitable exclusively for use in earthed power systems

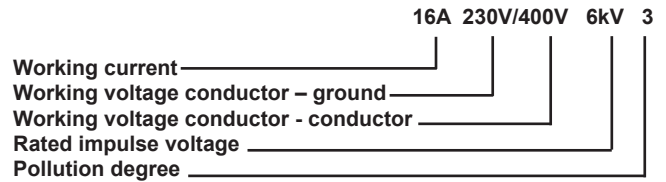
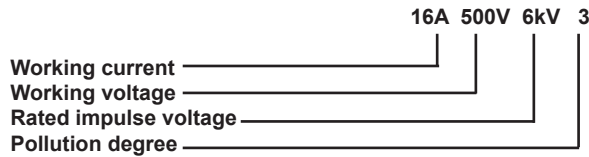

















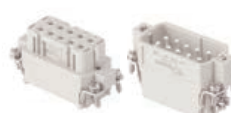
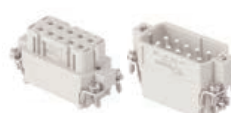









Inserts series	No. of poles (1) Main contacts + ⊕	Auxiliary contacts	EN 61984 (2001-11) Pollution degree 3			EN 61984 (2001-11) Pollution degree 2			UL/CSA	Max rated current (2)	Contact resistance
			Rated voltage	Inpulse withstand voltage	Pollution degree	Rated voltage	Inpulse withstand voltage	Pollution degree	Rated voltage		
S-A	3, 4		250V or 230/400V	4kV	3	230/400V	4kV	2	600V	10A	≤ 1 mΩ
S-A	10, 16, (32)		250V	4kV	3	230/400V	4kV	2	600V	16A	≤ 1 mΩ
S-D	8		50V	0,8kV	3				50V	10A	≤ 3 mΩ
S-D	7, 15, 25, 40, (50), 64, (80), (128)		250V	4kV	3	230/400V	4kV	2	600V	10A	≤ 3 mΩ
S-DD	24, 42,72, 108, (144), (216)		250V	4kV	3	230/400V	4kV	2	600V	10A	≤ 3 mΩ
S-E	6, 10, 16, 24, (32), (48)		500V	6kV	3	400/690V	6kV	2	600V	16A	≤ 1 mΩ
S-ES	6, 10, 16, 24, (32), (48)		500V	6kV	3	400/690V	6kV	2	600V	16A	≤ 3 mΩ
S-EP	6, 10, 16, 24, (32), (48)		500V	6kV	3	400/690V	6kV	2	600V	16A	≤ 3 mΩ
S-EE	10, 18, 32, 46, (64), (92)		500V	6kV	3	830V	8kV	2	600V	16A	≤ 1 mΩ
S-EAV	6, 10, 16, 24		500V	6kV	3				600V	16A	≤ 2 mΩ
S-EHV	3, 6, 10, (12), 16, (20), (32)	2,(4)	830V	8kV	3	1000V	8kV	2	600V	16A	≤ 1 mΩ
S-ESHV	3, 6, 10, (12), (20)	2,(4)	830V	8kV	3	1000V	8kV	2	600V	16A	≤ 3 mΩ
S-HSB	6, (12)		830V	6kV	3	1000V	8kV	2	600V	35A	≤ 0,5 mΩ
S-K 4/2	4 power contacts 2 signal contacts		830V 400V	8kV 6kV	3	1000V 400/690V	8kV 6kV	2	600V	80A 16A	≤ 0,3 mΩ ≤ 1 mΩ
S-K 4/8	4 power contacts 8 signal contacts		500V	6kV	3	400/690V	6kV	2	600V	80A 16A	≤ 0,3 mΩ ≤ 1 mΩ
S-Q 5/0	5		230/400V	4kV	3	320/500V	4kV	2	600V	16A	≤ 1 mΩ
S-Q 12	12		400V	6kV	3	400/690V	6kV	2	600V	10A	≤ 3 mΩ
S-QD 8/0	8 with thermoplastic enclosures 8 with metal enclosures		500V 230/400V	6kV 4kV	3 3	400/690V	6kV	2	600V	16A	≤ 1 mΩ
S-QD 17	17					250V	4kV	2	600V	10A	≤ 3 mΩ
S-QD 4/2	4 power contacts 2 signal contacts		400/690V 250V	6kV 6kV	3	-	-	-	600V 250V	40A 10A	≤ 0,3 mΩ ≤ 3 mΩ







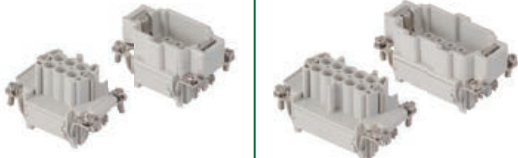
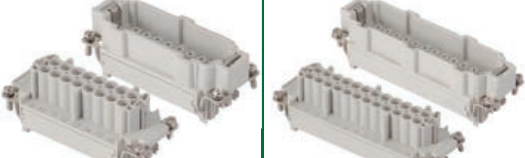

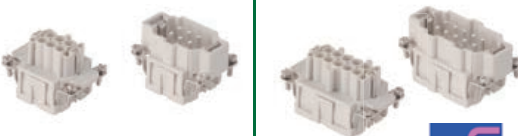
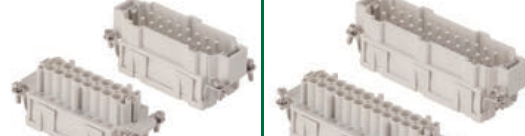
- 1) The polarities indicated in brackets are obtained using two inserts
- 2) See the inserts load diagrams to determine the actual limit working current according to the ambient temperature.
(please consult the Westec General Catalogue)

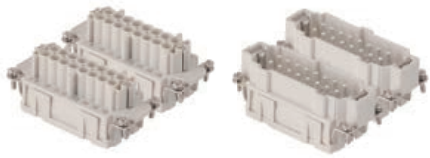
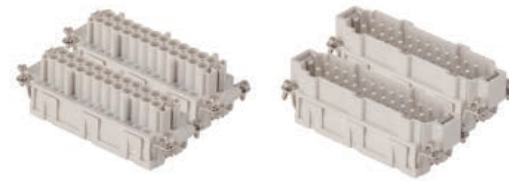



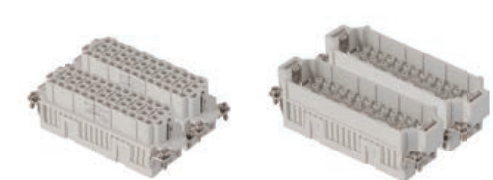

Remark:



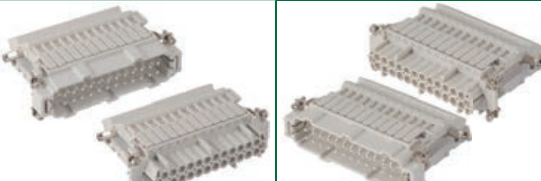



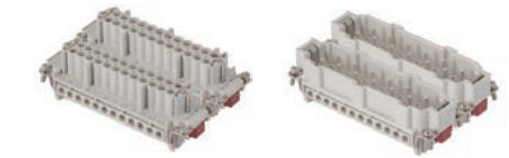





All inserts manufactured by Westec are suitable for stranded and solid conductors. According to EN61984 connectors should not be coupled and decoupled under electrical load.











Series S-A		Working current 10A		Voltage 230V/400V 4kV 3		UL (UL,CSA), RoHS	
No. of poles	3p + ⊕	3p + ⊕	3p + ⊕	4p + ⊕	4p + ⊕	4p + ⊕	4p + ⊕
Electrical characteristics according to EN61984 UL/CSA 600V-UL1977							
Color	Grey	Black	Black	Grey	Grey	Black	Black
Size	3A «21x21»	3A «21x21»	3A «21x21»	3A «21x21»	3A «21x21»	3A «21x21»	3A «21x21»
Terminal	Screw	Screw	Screw	Screw	Screw	Screw	Screw
Wire section mm ² /AWG	0,5÷2,5 / 20-14	0,5÷2,5 / 20-14	0,5÷2,5 / 20-14	0,5÷2,5 / 20-14	0,5÷2,5 / 20-14	0,5÷2,5 / 20-14	0,5÷2,5 / 20-14
Numbering	1- 3	1- 3	1- 3	1- 4	1- 4	1- 4	1- 4
Female insert Part. No.	7203.6001.0	7203.6001.1	7203.6001.1	7204.6002.0	7204.6002.0	7204.6002.1	7204.6002.1
Male insert Part. No.	7203.6101.0	7203.6101.1	7203.6101.1	7204.6102.0	7204.6102.0	7204.6102.1	7204.6102.1
Series S-A		Working current 16A		Voltage 250V 4kV 3		UL (UL,CSA), RoHS	
No. of poles	10p + ⊕	10p + ⊕	10p + ⊕	16p + ⊕	16p + ⊕	16p + ⊕	16p + ⊕
Electrical characteristics according to EN61984 UL/CSA 600V-UL1977 Euromap							
Size	10A «49x16»	10A «49x16»	10A «49x16»	16A «66x16»	16A «66x16»	16A «66x16»	16A «66x16»
Terminal	Screw	Crimp	Crimp	Screw	Screw	Crimp	Crimp
Wire section mm ² /AWG	0,5÷4 / 20-12	0,14÷4 / 26-12	0,14÷4 / 26-12	0,5÷4 / 20-12	0,5÷4 / 20-12	0,14÷4 / 26-12	0,14÷4 / 26-12
Numbering	1-10	1-10	1-10	1-16	1-16	1-16	1-16
Female insert Part. No.	7210.4401.0	7210.4451.0	7210.4451.0	7216.4402.0	7216.4402.0	7216.4452.0	7216.4452.0
Male insert Part. No.	7210.4411.0	7210.4461.0	7210.4461.0	7216.4412.0	7216.4412.0	7216.4462.0	7216.4462.0
Series S-A		Working current 16A		Voltage 250V 4kV 3		UL (UL,CSA), RoHS	
No. of poles	32p + ⊕			32p + ⊕			32p + ⊕
Electrical characteristics according to EN61984 UL/CSA 600V-UL1977 Euromap							
Size	32A «66x40»			32A «66x40»			32A «66x40»
Terminal	Screw			Crimp			Crimp
Wire section mm ² /AWG	0,5÷2,5 / 20-14			0,14÷4 / 26-12			0,14÷4 / 26-12
Numbering	1-16	17-32	17-32	1-16	17-32	17-32	17-32
Female insert Part. No.	7216.4402.0	7216.4403.0	7216.4403.0	7216.4452.0	7216.4452.0	7216.4453.0	7216.4453.0
Male insert Part. No.	7216.4412.0	7216.4413.0	7216.4413.0	7216.4462.0	7216.4462.0	7216.4463.0	7216.4463.0
Series S-E		Working current 16A		Voltage 500V 6kV 3		UL (UL,CSA), RoHS	
No. of poles	6p + ⊕	10p + ⊕	10p + ⊕	16p + ⊕	16p + ⊕	24p + ⊕	24p + ⊕
Electrical characteristics according to EN61984 UL/CSA 600V-UL1977							
Size	6B «44x27»	10B «57x27»	10B «57x27»	16B «77x27»	16B «77x27»	24B «104x27»	24B «104x27»
Terminal	Screw	Screw	Screw	Screw	Screw	Screw	Screw
Wire section mm ² /AWG	0,5÷4 / 21-12	0,5÷4 / 21-12	0,5÷4 / 21-12	0,5÷4 / 21-12	0,5÷4 / 21-12	0,5÷4 / 21-12	0,5÷4 / 21-12
Numbering	1-6	1-10	1-10	1-16	1-16	1-24	1-24
Female insert Part. No.	7306.6003.0	7310.6004.0	7310.6004.0	7316.6005.0	7316.6005.0	7324.6007.0	7324.6007.0
Male insert Part. No.	7306.6103.0	7310.6104.0	7310.6104.0	7316.6105.0	7316.6105.0	7324.6107.0	7324.6107.0





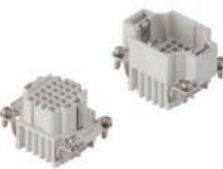

Series S-E	Working current 16A		Voltage 500V 6kV 3		UL (UL, CSA), CE (RoHS)
No. of poles	32p + ⊕		48p + ⊕		
Electrical characteristics according to EN61984 UL/CSA 600V-UL1977					
Size	32B «77x62»		48B «104x62»		
Terminal	Screw		Screw		
Wire section mm²/AWG	0,5÷4 / 20-12		0,5÷4 / 20-12		
Numbering	1-16	17-32	1-24	25-48	
Female insert Part. No.	7316.6005.0	7316.6006.0	7324.6007.0	7324.6008.0	
Male insert Part. No.	7316.6105.0	7316.6106.0	7324.6107.0	7324.6108.0	
Series S-E	Working current 16A		Voltage 500V 6kV 3		UL (UL, CSA), CE (RoHS)
No. of poles	6p + ⊕	10p + ⊕	16p + ⊕	24p + ⊕	
Electrical characteristics according to EN61984 UL/CSA 600V-UL1977					
Size	6B «44x27»	10B «57x27»	16B «77x27»	24B «104x27»	
Terminal	Crimp	Crimp	Crimp	Crimp	
Wire section mm²/AWG	0,14-4 / 26-12	0,14-4 / 26-12	0,14-4 / 26-12	0,14-4 / 26-12	
Numbering	1-6	1-10	1-16	1-24	
Female insert Part. No.	7306.6061.0	7310.6062.0	7316.6063.0	7324.6065.0	
Male insert Part. No.	7306.6161.0	7310.6162.0	7316.6163.0	7324.6165.0	
Series S-E	Working current 16A		Voltage 500V 6kV 3		UL (UL, CSA), CE (RoHS)
No. of poles	32p + ⊕		48p + ⊕		
Electrical characteristics according to EN61984 UL/CSA 600V-UL1977					
Size	32B «77x62»		48B «104x62»		
Terminal	Crimp		Crimp		
Wire section mm²/AWG	0,14÷4 / 26-12		0,14÷4 / 26-12		
Numbering	1-16	17-32	1-24	25-48	
Female insert Part. No.	7316.6063.0	7316.6064.0	7324.6065.0	7324.6066.0	
Male insert Part. No.	7316.6163.0	7316.6164.0	7324.6165.0	7324.6166.0	
Series S-ES	Working current 16A		Voltage 500V 6kV 3		UL (UL, CSA), CE (RoHS)
No. of poles	6p + ⊕	10p + ⊕	16p + ⊕	24p + ⊕	
Electrical characteristics according to EN61984 UL/CSA 600V-UL1977					
Size	6B «44x27»	10B «57x27»	16B «77x27»	24B «104x27»	
Terminal	Spring	Spring	Spring	Spring	
Wire section mm²/AWG	0,14÷4 / 26-14	0,14÷2,5 / 26-14	0,14÷2,5 / 26-14	0,14÷2,5 / 26-14	
Numbering	1-6	1-10	1-16	1-24	
Female insert Part. No.	7306.5851.0	7310.5852.0	7316.5853.0	7324.5855.0	
Male insert Part. No.	7306.5951.0	7310.5952.0	7316.5953.0	7324.5955.0	









Series S-ES		Working current 16A		Voltage 500V 6kV 3		UL (UL,CSA), CE (RoHS)	
No. of poles		32p + ⊕		48p + ⊕			
Electrical characteristics according to EN61984 UL/CSA 600V-UL1977							
Size		32B «77x62»		48B «104x62»			
Terminal		Spring		Spring			
Wire section mm²/AWG		0,14÷2,5 / 26-14		0,14÷2,5 / 26-14			
Numbering		1-16		17-32		1-24	
Female insert Part. No.		7316.5853.0		7316.5854.0		7324.5855.0	
Male insert Part. No.		7316.5953.0		7316.5954.0		7324.5955.0	
						7324.5856.0	
						7324.5956.0	
Series S-EE		Working current 16A		Voltage 500V 6kV 3		UL (UL,CSA), CE (RoHS)	
No. of poles		10p + ⊕		18p + ⊕		32p + ⊕	
Electrical characteristics according to EN61984 UL/CSA 600V-UL1977							
Size		6B «44x27»		10B «57x27»		16B «77x27»	
Terminal		Crimp		Crimp		Crimp	
Wire section mm²/AWG		0,14÷4 / 26-12		0,14÷4 / 26-12		0,14÷4 / 26-12	
Numbering		1-10		1-18		1-32	
Female insert Part. No.		7310.6090.0		7318.6091.0		7332.6092.0	
Male insert Part. No.		7310.6190.0		7318.6191.0		7332.6192.0	
						7346.6094.0	
						7346.6194.0	
Series S-EE		Working current 16A		Voltage 500V 6kV 3		UL (UL,CSA), CE (RoHS)	
No. of poles		64p + ⊕		92p + ⊕			
Electrical characteristics according to EN61984 UL/CSA 600V-UL1977							
Size		32B «77x62»		48B «104x62»			
Terminal		Crimp		Crimp			
Wire section mm²/AWG		0,14÷4 / 26-12		0,14÷4 / 26-12			
Numbering		1-32		33-64		1-46	
Female insert Part. No.		7332.6092.0		7332.6093.0		7346.6094.0	
Male insert Part. No.		7332.6192.0		7332.6193.0		7346.6194.0	
						7346.6095.0	
						7346.6195.0	
Series S-EAV		Working current 16A		Voltage 500V 6kV 3		UL (UL,CSA), CE (RoHS)	
No. of poles		6p + ⊕ Left		6p + ⊕ Right		10p + ⊕ Left	
Electrical characteristics according to EN61984 UL/CSA 600V-UL1977							
Size		6B «44x27»		10B «57x27»		16B «77x27»	
Terminal		Screw with terminal block		Screw with terminal block		Screw with terminal block	
Wire section mm²/AWG		0,2÷2,5 / 24-14		0,2÷2,5 / 24-14		0,2÷2,5 / 24-14	
Numbering		1-6		1-6		1-10	
Female insert Part. No.		7406.6011.0		7406.6012.0		7410.6013.0	
Male insert Part. No.		7406.6111.0		7406.6112.0		7410.6113.0	
						7410.6014.0	
						7410.6114.0	

Series S-EAV	Working current 16A		Voltage 500V 6kV 3	
			UL (UL, CSA), CE (RoHS)	
No. of poles	16p + ⊕ Left	16p + ⊕ Right	24p + ⊕ Left	24p + ⊕ Right
Electrical characteristics according to EN61984 UL/CSA 600V-UL1977				
Size	16B «77x27»	16B «77x27»	24B «104x27»	24B «104x27»
Terminal	Screw with terminal block	Screw with terminal block	Screw with terminal block	Screw with terminal block
Wire section mm²/AWG	0,2÷2,5 / 24-14	0,2÷2,5 / 24-14	0,2÷2,5 / 24-14	0,2÷2,5 / 24-14
Numbering	1-16	1-16	1-24	1-24
Female insert Part. No.	7416.6015.0	7416.6016.0	7424.6017.0	7424.6018.0
Male insert Part. No.	7416.6115.0	7416.6116.0	7424.6117.0	7424.6118.0
Series S-EHV	Working current 16A		Voltage 830V 8kV 3	
			UL (UL, CSA), CE (RoHS)	
No. of poles	3p + ⊕+2p	6p + ⊕+2p	10p + ⊕+2p	16p + ⊕+2p
Electrical characteristics according to EN61984 UL/CSA 600V-UL1977				
Size	10B «57x27»	16B «77x27»	24B «104x27»	24B «104x27»
Terminal	Screw	Screw	Screw	Screw
Wire section mm²/AWG	0,5÷4 / 20-12	0,5÷4 / 20-12	0,5÷4 / 20-12	0,5÷4 / 20-12
Numbering	1-10	1-16	1-24	1-16
Female insert Part. No.	7503.6031.0	7506.6032.0	7510.6033.0	7516.6034.0
Male insert Part. No.	7503.6131.0	7506.6132.0	7510.6133.0	7516.6134.0
Series S-EHV	Working current 16A		Voltage 830V 8kV 3	
			UL (UL, CSA), CE (RoHS)	
No. of poles	12(6x2)p + ⊕+4p		20(10x2)p + ⊕+4p	
Electrical characteristics according to EN61984 UL/CSA 600V-UL1977				
Size	32B «77x62»		48B «104x62»	
Terminal	Screw		Screw	
Wire section mm²/AWG	0,5÷4 / 20-12		0,5÷4 / 20-12	
Numbering	1-16	17-32	1-24	25-48
Female insert Part. No.	7506.6032.0	7506.6052.0	7510.6033.0	7510.6053.0
Male insert Part. No.	7506.6132.0	7506.6152.0	7510.6133.0	7510.6153.0
Series S-EHV	Working current 16A		Voltage 830V 8kV 3	
			UL (UL, CSA), CE (RoHS)	
No. of poles	32(16x2)p + ⊕+2p	3p + ⊕+2p	6p + ⊕+2p	10p + ⊕+2p
Electrical characteristics according to EN61984 UL/CSA 600V-UL1977				
Size	48B «104x62»	10B «57x27»	16B «77x27»	24B «104x27»
Terminal	Screw	Crimp	Crimp	Crimp
Wire section mm²/AWG	0,5÷4 / 20-12	0,14÷4 / 26-12	0,14÷4 / 26-12	0,14÷4 / 26-12
Numbering	1-16 17-32	1-10	1-16	1-24
Female insert Part. No.	7516.6034.0 7516.6035.0	7503.6071.0	7506.6072.0	7510.6073.0
Male insert Part. No.	7516.6134.0 7516.6135.0	7503.6171.0	7506.6172.0	7510.6173.0

Series S-EHV		Working current 16A		Voltage 830V 8kV 3		UL (UL,CSA), CE (RoHS)			
No. of poles		12(6x2)p + ⊕+4p		20(10x2)p + ⊕+4p					
Electrical characteristics according to EN61984 UL/CSA 600V-UL1977									
Size		32B «77x62»		48B «104x62»					
Terminal		Crimp		Crimp					
Wire section mm²/AWG		0,14 ÷ 4 / 26-12		0,14 ÷ 4 / 26-12					
Numbering		1-16		17-32		1-24		25-48	
Female insert Part. No.		7506.6072.0		7506.6082.0		7510.6073.0		7510.6083.0	
Male insert Part. No.		7506.6172.0		7506.6182.0		7510.6173.0		7510.6183.0	
Series S-ESHV		Working current 16A		Voltage 830V 8kV 3		UL (UL,CSA), CE (RoHS)			
No. of poles		3p + ⊕+2p		6p + ⊕+2p		10p + ⊕+2p			
Electrical characteristics according to EN61984 UL/CSA 600V-UL1977									
Size		10B «57x27»		16B «77x27»		24B «104x27»			
Terminal		Spring		Spring		Spring			
Wire section mm²/AWG		0,14 ÷ 2,5 / 26-14		0,14 ÷ 2,5 / 26-14		0,14 ÷ 2,5 / 26-14			
Numbering		1-10		1-16		1-24			
Female insert Part. No.		7503.5831.0		7506.5832.0		7510.5833.0			
Male insert Part. No.		7503.5931.0		7506.5932.0		7510.5933.0			
Series S-ESHV		Working current 16A		Voltage 830V 8kV 3		UL (UL,CSA), CE (RoHS)			
No. of poles		12(6x2)p + ⊕+4p		20(10x2)p + ⊕+4p					
Electrical characteristics according to EN61984 UL/CSA 600V-UL1977									
Size		32B «77x62»		48B «104x62»					
Terminal		Spring		Spring					
Wire section mm²/AWG		0,14 ÷ 2,5 / 26-14		0,14 ÷ 2,5 / 26-14					
Numbering		1-16		17-32		1-24		25-48	
Female insert Part. No.		7506.5832.0		7506.5834.0		7510.5833.0		7510.5835.0	
Male insert Part. No.		7506.5932.0		7506.5934.0		7510.5933.0		7510.5935.0	
Series S-HSB		Working current 35A		Voltage 830V 6kV 3		UL (UL,CSA), CE (RoHS)			
No. of poles		6p + ⊕		6p + ⊕		12p + ⊕			
Electrical characteristics according to EN61984 UL/CSA 600V-UL1977									
Size		16B «77x27»		16B «77x27»		32B «77x62»			
Terminal		Screw		Screw		Screw			
Wire section mm²/AWG		1,5 ÷ 6 / 16-10		1,5 ÷ 6 / 16-10		1,5 ÷ 6 / 16-10			
Numbering		1-6		1-6		1-6		7-12	
Female insert Part. No.		7306.6041.0		7306.6141.0		7306.6041.0		7306.6042.0	
Male insert Part. No.		7306.6041.0		7306.6141.0		7306.6141.0		7306.6142.0	

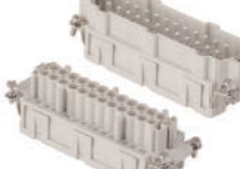
Series S-D	10A 50V/0,8kV/3		Current 10A Voltage 250V/4kV/3		UL (UL,CSA), CE (RoHS)	
No. of poles	8p	7p + ⊕	15p + ⊕	25p + ⊕		
Electrical characteristics according to EN61984 UL/CSA 600V-UL1977						
Size	3A «21x21»	3A «21x21»	10A «49x16»	16A «66x16»		
Terminal	Crimp	Crimp	Crimp	Crimp		
Wire section mm²/AWG	0,14÷2,5 / 26-14	0,14÷2,5 / 26-14	0,14÷2,5 / 26-14	0,14÷2,5 / 26-14		
Numbering	1-8	1-7 Grey Black	1-15	1-25		
Female insert Part. No.	7108.4002.0	7107.4001.0 7107.4001.1	7115.4006.0	7125.4012.0		
Male insert Part. No.	7108.4102.0	7107.4101.0 7107.4101.1	7115.4106.0	7125.4112.0		
Series S-D	Working current 10A		Voltage 250V/4kV/3		UL (UL,CSA), CE (RoHS)	
No. of poles	40p + ⊕	50p (25x2) + ⊕	64p + ⊕	80p (40x2) + ⊕		
Electrical characteristics according to EN61984 UL/CSA 600V-UL1977						
Size	16B «77x27»	32A «66x40»	24B «104x27»	32B «77x62»		
Terminal	Crimp	Crimp	Crimp	Crimp		
Wire section mm²/AWG	0,14÷2,5 / 26-14	0,14÷2,5 / 26-14	0,14÷2,5 / 26-14	0,14÷2,5 / 26-14		
Numbering	1-40	1-25 Euromap	1-64	1-40		
Female insert Part. No.	7140.4018.0	7125.4012.0 7125.4012.3	7164.4024.0	7140.4018.0 x 2		
Male insert Part. No.	7140.4118.0	7125.4112.0 7125.4112.3	7164.4124.0	7140.4118.0 x 2		
Series S-D / S-DD	Working current 10A		Voltage 250V/4kV/3		UL (UL,CSA), CE (RoHS)	
No. of poles	S-D 128(64x2)p + ⊕	S-DD 24p + ⊕	S-DD 42p + ⊕	S-DD 72p + ⊕		
Electrical characteristics according to EN61984 UL/CSA 600V-UL1977						
Size	48B «104x62»	6B «44x27»	10B «57x27»	16B «77x27»		
Terminal	Crimp	Crimp	Crimp	Crimp		
Wire section mm²/AWG	0,14÷2,5 / 26-14	0,14÷2,5 / 26-14	0,14÷2,5 / 26-14	0,14÷2,5 / 26-14		
Numbering	1-64	1-24	1-42	1-72		
Female insert Part. No.	7164.4024.0 x 2	7124.4040.0	7142.4046.0	7172.4052.0		
Male insert Part. No.	7164.4124.0 x 2	7124.4140.0	7142.4146.0	7172.4152.0		
Series S-DD	Working current 10A		Voltage 250V/4kV/3		UL (UL,CSA), CE (RoHS)	
No. of poles	108p + ⊕	144(72x2)p + ⊕	216(108x2)p + ⊕			
Electrical characteristics according to EN61984 UL/CSA 600V-UL1977						
Size	24B «104x27»	32B «77x62»	48B «104x62»			
Terminal	Crimp	Crimp	Crimp			
Wire section mm²/AWG	0,14÷2,5 / 26-14	0,14÷2,5 / 26-14	0,14÷2,5 / 26-14			
Numbering	1-108	1-72 73-144	1-108 109-216			
Female insert Part. No.	7108.4058.0	7172.4052.0 7172.4053.0	7108.4058.0 7108.4059.0			
Male insert Part. No.	7108.4158.0	7172.4152.0 7172.4153.0	7108.4158.0 7108.4159.0			

Series S-K	Power 80A 830V/8kV/3 Signal 16A 400V/6kV/3	Power 80A 500V/8kV/3 Signal 16A 500V/6kV/3
No. of poles	4p x 80A + ⊕ - 4p x 80A + 2p x 16A + ⊕	4p x 80A + 8p x 16A + ⊕
Electrical characteristics according to EN61984 UL/CSA 600V-UL1977 UL (UL, CSA) CE (RoHS)		
Size	16B «77x27»	24B «104x27»
Terminal	Screw	Screw
Wire section mm²/AWG	Power 1,5 ÷ 16/16+5 - Signal 0,5 ÷ 2,5/20-14	Power 1,5 ÷ 16/16-5 - Signal 0,5 ÷ 2,5/20-14
Numbering	1-4	1-4/11-12
Female insert Part. No.	7304.6044.0	7306.6045.0
Male insert Part. No.	7304.6144.0	7306.6145.0
Series	S-Q 5/0 16A 230V/400V/4kV/3	S-Q 12 10A 400V/4kV/3
No. of poles	5p + ⊕	12p + ⊕
Electrical characteristics according to EN61984 UL/CSA 600V-UL1977 UL (UL, CSA) CE (RoHS)		
Size	3A «21x21»	3A «21x21»
Terminal	Crimp	Crimp
Wire section mm²/AWG	0,14 ÷ 2,5 / 26-14	0,14 ÷ 2,5 / 26-14
Numbering	1-5	1-12
Female insert Part. No.	7605.5801.0	7612.5805.0
Male insert Part. No.	7605.5901.0	7612.5905.0
Series	S-QD 8/0 16A 500V/6kV/3	S-QD 17 10A 250V/4kV/3
No. of poles	8p + ⊕	17p + ⊕
Electrical characteristics according to EN61984 UL/CSA 600V-UL1977 UL (UL, CSA), CE (RoHS)		
Size	«32x13»	«32x13»
Terminal	Crimp	Crimp
Wire section mm²/AWG	0,14 ÷ 4 / 26-12	0,14 ÷ 2,5 / 26-14
Numbering	1-8	1-17
Female insert Part. No.	7608.5807.0	7617.5811.0
Male insert Part. No.	7608.5907.0	7617.5911.0
Series	S-QD 4/2	Power 40A 400V/690V/4kV/3 Signal 10A 250V/4kV/3
No. of poles	4p x 40A + 2p x 10A + ⊕	
Electrical characteristics according to EN61984 UL/CSA 600V-UL1977 UL (UL, CSA), CE (RoHS)		
Size	«32x13»	
Terminal	Crimp	
Wire section mm²/AWG	Power 1,5 ÷ 6/16-10 - Signal 0,14 ÷ 2,5/26-14	
Numbering	1-4	11-12
Female insert Part. No.	7606.5815.0	
Male insert Part. No.	7606.5915.0	

Series S-EP <i>New</i>		Working current 16A		Voltage 500V 6kV 3		UL (UL,CSA), CE (RoHS)		
No. of poles	6p + ⊕	10p + ⊕	16p + ⊕	24p + ⊕	32p + ⊕	48p + ⊕		
Electrical characteristics according to EN61984 UL/CSA 600V-UL1977  Size Terminal Wire section mm²/AWG Numbering Female insert Part. No. Male insert Part. No.	 6B «44x27» Push in 0,14÷2,5 / 26-14 1-6 7306.5861.0 7306.5961.0	 10B «57x27» Push in 0,14÷2,5 / 26-14 1-10 7310.5862.0 7310.5962.0	 16B «77x27» Push in 0,14÷2,5 / 26-14 1-16 7316.5863.0 7316.5963.0	 24B «104x27» Push in 0,14÷2,5 / 26-14 1-24 7324.5865.0 7324.5965.0	 32B «77x62» Push in 0,14÷2,5 / 26-14 1-16 7316.5863.0 7316.5963.0	 48B «104x62» Push in 0,14÷2,5 / 26-14 17-32 7316.5864.0 7316.5964.0	 1-24 7324.5865.0 7324.5965.0	 25-48 7324.5866.0 7324.5966.0

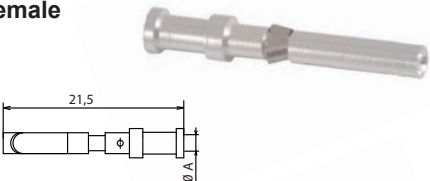
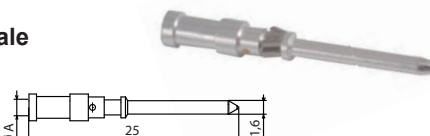

Remark: With solid conductors or stranded with bush terminals

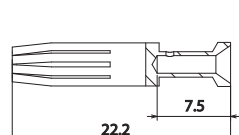
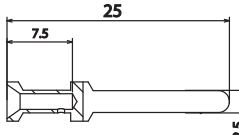
10A crimp contacts, turned	Stripping length	Numbering	Ø A	Wire mm²	Wire gauge	Part No.		
						Silver plated	Gold plated	
Female 	8	1	0,90	0.14 - 0.37	26-22 AWG	7100.4201.0	7100.4201.1	
	8	2	1,10	0.5	20 AWG	7100.4202.0	7100.4202.1	
	8	2	1,30	0.75	18 AWG	7100.4203.0	7100.4203.1	
	8	3	1,45	1.0	17 AWG	7100.4204.0	7100.4204.1	
	8	4	1,75	1.5	16 AWG	7100.4205.0	7100.4205.1	
	6	5	2,25	2.5	14 AWG	7100.4206.0	7100.4206.1	
	Male 	8	1	0,90	0.14 - 0.37	26-22 AWG	7100.4211.0	7100.4211.1
		8	2	1,10	0.5	20 AWG	7100.4212.0	7100.4212.1
		8	2	1,30	0.75	18 AWG	7100.4213.0	7100.4213.1
		8	3	1,45	1.0	17 AWG	7100.4214.0	7100.4214.1
8		4	1,75	1.5	16 AWG	7100.4215.0	7100.4215.1	
For inserts: S-D, S-DD, S-Q, S-QD, S-M - Material: Copper alloy - Surface: Hard silver or hard gold	6	5	2,25	2.5	14 AWG	7100.4216.0	7100.4216.1	

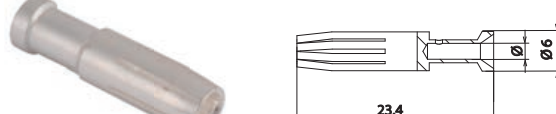
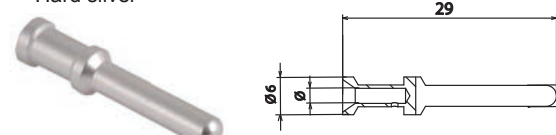
16A crimp contacts, turned	No. of grooves	Wire mm²	Wire gauge	Part No.		
				Silver plated	Gold plated	
Female 	0	0.14 - 0.37	26-22 AWG	7300.6240.0	7300.6240.1	
	0	0.5	20 AWG	7300.6241.0	7300.6241.1	
	1	0.75	18 AWG	7300.6239.0	7300.6239.1	
	1	1.0	17 AWG	7300.6242.0	7300.6242.1	
	2	1.5	16 AWG	7300.6243.0	7300.6243.1	
	3	2.5	14 AWG	7300.6244.0	7300.6244.1	
	1 Wide	3.0	12 AWG	7300.6238.0	7300.6238.1	
	0	4.0	12 AWG	7300.6245.0	7300.6245.1	
	Male 	0	0.14 - 0.37	26-22 AWG	7300.6237.0	7300.6237.1
		0	0.5	20 AWG	7300.6246.0	7300.6246.1
1		0.75	18 AWG	7300.6236.0	7300.6236.1	
1		1.0	17 AWG	7300.6247.0	7300.6247.1	
2		1.5	16 AWG	7300.6248.0	7300.6248.1	
3		2.5	14 AWG	7300.6249.0	7300.6249.1	
1 Wide		3.0	12 AWG	7300.6235.0	7300.6235.1	
0		4.0	12 AWG	7300.6250.0	7300.6250.1	
For inserts: S-A, S-E, S-EE, S-EHV, S-Q, S-QD, S-M - Material: Copper alloy - Surface: Hard silver or hard gold - Stripping length: 7,5 mm - Identification: By grooves						

40A crimp contacts, turned	Stripping length	Ø	Wire mm²	Wire gauge	Part.No.	
					Silver plated	
Female 	9	1,75	1,5	16 AWG	7600.5700.0	
	9	2,25	2.5	14 AWG	7600.5701.0	
	9,6	2,85	4.0	12 AWG	7600.5702.0	
	9,6	3,5	6.0	10 AWG	7600.5703.0	
	For inserts: S-QD, S-M - Material: Copper alloy - Surface: Hard silver	9	1,75	1,5	16 AWG	7600.5710.0
Male 		9	2,25	2.5	14 AWG	7600.5711.0
		9,6	2,85	4.0	12 AWG	7600.5712.0
	9,6	3,5	6.0	10 AWG	7600.5713.0	

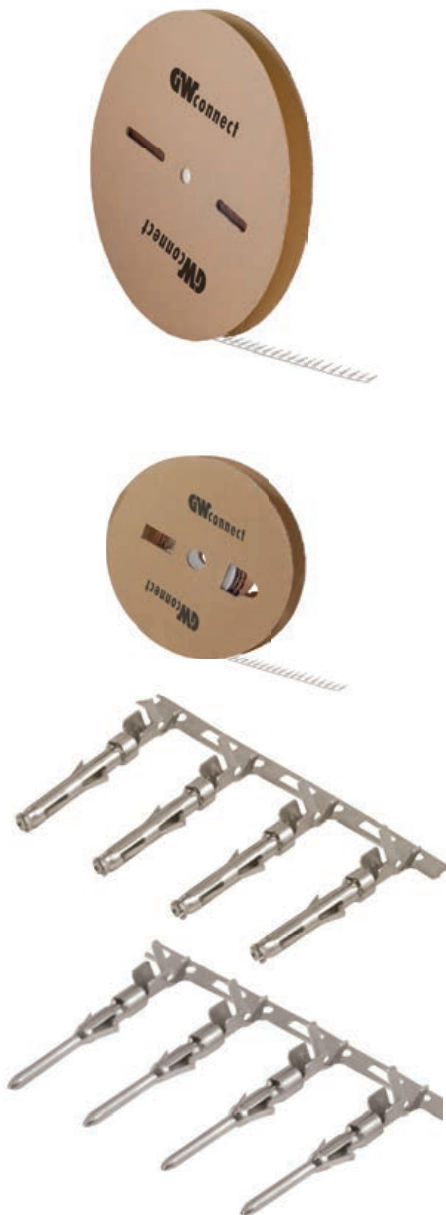
For the best performance and the lowest contact resistance, Westec recommends the use of the manual tools, die sets and machines illustrated in the pages 52-53 of this catalogue

Stamped crimp contacts	Packing	Type	Wire mm ²	Wire gauge	Female Part No.			
					Silver plated	Tin plated	Gold plated	
 <p>   </p> <p>Type:</p> <ul style="list-style-type: none"> - A: Single contact - B: On reel dia 200 mm. - C: On reel dia 500 mm. - Material: Phosphor bronze - Surface: Hard silver or hard gold or tin plated 	100	A female	0.14 - 1.0	26-17 AWG	7100.4031.0	7100.4031.2	7100.4031.1	
	400	B female	0.14 - 1.0	26-17 AWG	7100.4032.0	7100.4032.2	7100.4032.1	
	2000	C female	0.14 - 1.0	26-17 AWG	7100.4033.0	7100.4033.2	7100.4033.1	
	100	A female	0.75 - 2.5	18-14 AWG	7100.4037.0	7100.4037.2	7100.4037.1	
	400	B female	0.75 - 2.5	18-14 AWG	7100.4038.0	7100.4038.2	7100.4038.1	
	2000	C female	0.75 - 2.5	18-14 AWG	7100.4039.0	7100.4039.2	7100.4039.1	
	<p>- For the best performance and the lowest contact resistance, Westec recommends the use of the manual tools, die sets, and machines illustrated in the section 60 of this catalogue</p> <p>- For stranded wires only</p> <p>- Low insertion force</p> <p>- For inserts S-DD series we recommend contacts for wire sections 0.14 - 1.0 mm² (AWG 26 - 17) only.</p>							
		Packing	Type	Wire mm ²	Wire gauge	Male Part No.		
						Silver plated	Tin plated	Gold plated
		100	A male	0.14 - 1.0	26-17 AWG	7100.4071.0	7100.4071.2	7100.4071.1
		400	B male	0.14 - 1.0	26-17 AWG	7100.4072.0	7100.4072.2	7100.4072.1
		2000	C male	0.14 - 1.0	26-17 AWG	7100.4073.0	7100.4073.2	7100.4073.1
	100	A male	0.75 - 2.5	18-14 AWG	7100.4077.0	7100.4077.2	7100.4077.1	
	400	B male	0.75 - 2.5	18-14 AWG	7100.4078.0	7100.4078.2	7100.4078.1	
	2000	C male	0.75 - 2.5	18-14 AWG	7100.4079.0	7100.4079.2	7100.4079.1	
<p>- For the best performance and the lowest contact resistance, Westec recommends the use of the manual tools, die sets, and machines illustrated in the section 60 of this catalogue</p> <p>- For stranded wires only</p> <p>- Low insertion force</p> <p>- For inserts S-DD series we recommend contacts for wire sections 0.14 - 1.0 mm² (AWG 26 - 17) only.</p>								



















For inserts:
S-D, S-DD, S-Q, S-QD, S-M



Dimensions in mm. Part No. bold letters refer to standard availability. Normal letters refer to items on special request.



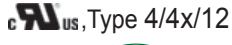

Crimping tools: see page 53

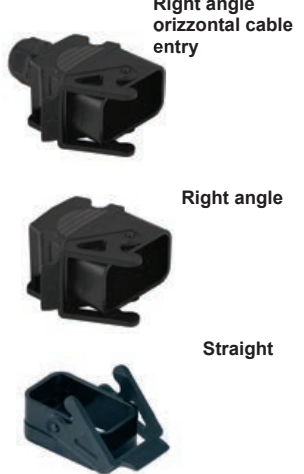





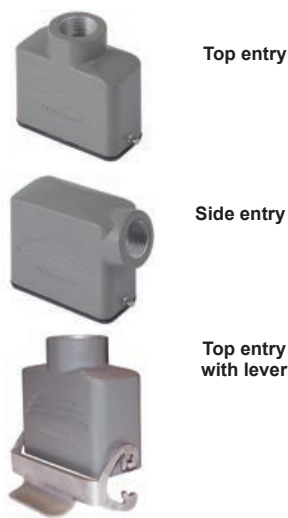
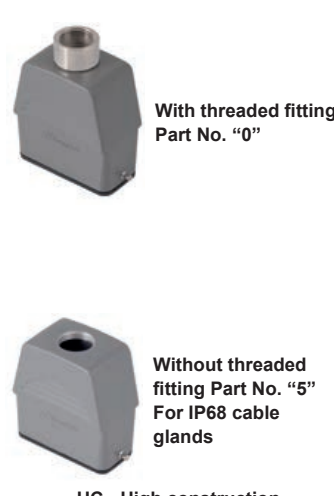







Design and innovation

Hoods top entry			Hoods side entry			Hoods top entry with lever			Covers with gasket for female inserts		
 Polyamide type  Metal type			 Polyamide type  Metal type			 Polyamide type  Metal type			 Polyamide type  Metal type		
Size		Part No.	Size	Thread	Part No.	Size	Thread	Part No.	Size		Part No.
3A «21x21»	M 20	Grey plastic 7803.6227.0	3A «21x21»	M 20	Grey plastic 7803.6229.0	3A «21x21»	M 20	Grey plastic 7803.6231.0 7803.6211.0	3A «21x21»		Grey plastic 7803.6801.0
3A «21x21»	Pg 11	7803.6207.0	3A «21x21»	Pg 11	7803.6209.0	3A «21x21»	Pg 11	Black plastic 7803.6231.1 7803.6211.1	3A «21x21»		Black plastic 7803.6801.1
3A «21x21»	M 20	Black plastic 7803.6227.1	3A «21x21»	M 20	Black plastic 7803.6229.1	3A «21x21»	M 20	Metal 7803.6232.0 7803.6212.0	3A «21x21»		Metal 7803.6802.0
3A «21x21»	Pg 11	7803.6207.1	3A «21x21»	Pg 11	7803.6209.1	3A «21x21»	Pg 11	With inox lever 7803.6232.A 7803.6212.A	3A «21x21»		
3A «21x21»	M 20	Metal 7803.6228.0	3A «21x21»	M 20	Metal 7803.6230.0	3A «21x21»	M 20				
3A «21x21»	Pg 11	7803.6208.0	3A «21x21»	Pg 11	7803.6210.0	3A «21x21»	Pg 11				
Housings bulkhead mounting			Housings bulkhead mounting right angle			Housings surface mounting one side cable entry			Covers for male inserts		
 Polyamide type  Metal type			 Polyamide type  Metal type			 Polyamide type  Metal type			 Polyamide type  Metal type		
Size		Part No.	Size		Part No.	Size	Thread	Part No.	Size		Part No.
3A «21x21»		Grey plastic 7803.6201.0	3A «21x21»		Grey plastic 7803.6203.0	3A «21x21»	M 20	Grey plastic 7803.6225.0 7803.6205.0	3A «21x21»		Grey plastic 7803.6803.0
3A «21x21»		Black plastic 7803.6201.1	3A «21x21»		Black plastic 7803.6203.1	3A «21x21»	Pg 11	Black plastic 7803.6225.1 7803.6205.1	3A «21x21»		Black plastic 7803.6803.1
3A «21x21»		Metal 7803.6202.0	3A «21x21»		Metal 7803.6204.0	3A «21x21»	M 20	Metal 7803.6226.0 7803.6206.0	3A «21x21»		Metal 7803.6804.0
3A «21x21»	With inox lever	7803.6202.A	3A «21x21»	With inox lever	7803.6204.A	3A «21x21»	Pg 11	With inox lever 7803.6226.A 7803.6206.A	3A «21x21»		
Type: STD for inserts size 3A, S-A, S-D, S-Q series			 			For more technical details and STD-HV, HE, HE-HV, EMC types, please consult the Westec General Catalogue			Accessories, cable glands and tools see page: 42 + 51		

Insulating hoods STD type, black color			Insulating bulkhead mounting housings			Hood metal type			Bulkhead mounting housing with lever, metal type		
											
Size	Cable Dia	Part No.	Size	Cable Dia	Part No.	Type	Thread	Part No.	Type		Part No.
«32x13»	8 - 14	Top entry 7908.6646.1	«32x13»	8 - 14	Right angle orizontal cable entry 7808.6663.1	HE	M 20	Top entry 7808.6654.6	HE		Straight 7808.6662.1
«32x13»	11 - 18	7908.6648.1	«32x13»	11 - 18	7808.6664.1	HE	M 25	7808.6655.6			
«32x13»	8 - 14	Side entry 7908.6640.1	«32x13»	-	Right angle 7808.6669.1						
«32x13»	11 - 18	7908.6643.1	«32x13»	-	Top entry with lever 7808.6660.1	HE	M 20	Side entry 7808.6650.6			
«32x13»	8 - 14	Top entry with lever 7908.6667.1	Insulating cover			HE	M 25	7808.6651.6			
«32x13»	11 - 18	7908.6668.1						Metal cable glands to be ordered separately.			
						Size			Part No.		
						«32x13»			Cover with gasket for female insert 7808.6665.1		
			«32x13»		Cover without gasket for male insert 7808.6666.1						
Type: STD, HE for S-QD inserts						For more technical details and STD-HV, HE, HE-HV, EMC types, please consult the Westec General Catalogue			Accessories, cable glands and tools see page: 42 ÷ 51		

Surface mounting housings			Bulkhead mounting housings			Hoods with 2 pegs and with one lever			Hoods Top entry with 2 pegs for one lever								
 <p>With cover</p>			 <p>With cover</p>			 <p>Top entry Side entry Top entry with lever</p>			 <p>With threaded fitting Part No. "0" Without threaded fitting Part No. "5" For IP68 cable glands HC - High construction</p>								
Size	Thread	Part No.	Size		Part No.	Size	Thread	Part No.	Size	Thread	Part No.						
10A «49x16»	M 20	7810.4501.0	10A «49x16»		7810.4541.0	Hoods with 2 pegs			10A «49x16»	M 20	7810.4561.0						
10A «49x16»	M 20X2	7810.4502.0	16A «66x16»		7816.4543.0				10A «49x16»	M 25	7810.4562.0						
10A «49x16»	M 25	7810.4503.0							10A «49x16»	Pg 16	7810.4563.0						
10A «49x16»	M 25X2	7810.4504.0							10A «49x16»	Pg 21	7810.4564.0						
10A «49x16»	Pg 16	7810.4505.0				10A «49x16»	M 20	7810.4550.0	Without threaded fitting								
10A «49x16»	Pg 16X2	7810.4506.0	10A «49x16»		7810.4542.0	10A «49x16»	M 25	7810.4551.0									
10A «49x16»	Pg 21	7810.4507.0	16A «66x16»		7816.4544.0	10A «49x16»	Pg 13,5	7810.4552.0	10A «49x16»	M 20	7810.4561.5						
10A «49x16»	Pg 21X2	7810.4508.0				10A «49x16»	Pg 16	7810.4553.0	10A «49x16»	M 25	7810.4562.5						
16A «66x16»	M 20	7816.4521.0	Cover with 2 pegs			16A «66x16»	M 20	7816.4555.0	10A «49x16»	Pg 16	7810.4563.5						
16A «66x16»	M 20X2	7816.4522.0	Cover with one lever			16A «66x16»	M 25	7816.4556.0	10A «49x16»	Pg 21	7810.4564.5						
16A «66x16»	M 25	7816.4523.0				16A «66x16»	Pg 13,5	7816.4557.0	16A «66x16»	M 20	7816.4566.0						
16A «66x16»	M 25X2	7816.4524.0				16A «66x16»	Pg 16	7816.4558.0	16A «66x16»	M 25	7816.4567.0	16A «66x16»	M 25	7816.4567.0			
16A «66x16»	Pg 16	7816.4525.0				Side entry			10A «49x16»	M 20	7810.4571.0	16A «66x16»	Pg 16	7816.4568.0			
16A «66x16»	Pg 16X2	7816.4526.0				Without threaded fitting			10A «49x16»	M 25	7810.4572.0	16A «66x16»	Pg 21	7816.4569.0			
16A «66x16»	Pg 21	7816.4527.0							10A «49x16»	Pg 16	7810.4573.0	16A «66x16»	M 20	7816.4575.0	16A «66x16»	M 20	7816.4566.5
16A «66x16»	Pg 21X2	7816.4528.0							16A «66x16»	M 25	7816.4576.0	16A «66x16»	Pg 16	7816.4577.0	16A «66x16»	M 25	7816.4567.5
10A «49x16»	M 20	7810.4511.0							Hoods top entry with lever			16A «66x16»	Pg 16	7816.4577.0	16A «66x16»	Pg 16	7816.4568.5
10A «49x16»	M 20X2	7810.4512.0										16A «66x16»	Pg 21	7816.4569.5			
10A «49x16»	M 25	7810.4513.0							* Without cable entry								
10A «49x16»	M 25X2	7810.4514.0															
10A «49x16»	Pg 16	7810.4515.0				10A «49x16»	M 20	7810.4490.0	10A «49x16»	*	7810.4565.0						
10A «49x16»	Pg 16X2	7810.4516.0				10A «49x16»	M 25	7810.4491.0	16A «66x16»	*	7816.4570.0						
10A «49x16»	Pg 21	7810.4517.0				10A «49x16»	Pg 13,5	7810.4992.0									
10A «49x16»	Pg 21X2	7810.4518.0				10A «49x16»	Pg 16	7810.4993.0									
16A «66x16»	M 20	7816.4531.0				16A «66x16»	M 20	7816.4994.0									
16A «66x16»	M 20X2	7816.4532.0				16A «66x16»	M 25	7816.4995.0									
16A «66x16»	M 25	7816.4533.0	10A «49x16»		Cover with 2 pegs and gasket for housings with one lever 7810.4591.0	16A «66x16»	Pg 13,5	7816.4996.0									
16A «66x16»	M 25X2	7816.4534.0	16A «66x16»		7816.4592.0	16A «66x16»	Pg 16	7816.4997.0									
16A «66x16»	Pg 16	7816.4535.0				16A «66x16»	M 20	7816.4998.0									
16A «66x16»	Pg 16X2	7816.4536.0				16A «66x16»	M 25	7816.4999.0									
16A «66x16»	Pg 21	7816.4537.0				16A «66x16»	Pg 13,5	7816.4999.0									
16A «66x16»	Pg 21X2	7816.4538.0	10A «49x16»		Cover with one lever for hoods with 2 pegs 7810.4594.0	16A «66x16»	Pg 16	7816.4997.0									
			16A «66x16»		7816.4595.0												
Type: STD for inserts size 10A and 16A, S-A, S-D series						For more technical details and STD-HV, HE, HE-HV, EMC types, please consult the Westec General Catalogue			Accessories, cable glands and tools see page: 42 ÷ 51								

Hoods side entry with 4 pegs for 2 levers	Reversed locking hoods, top entry, with 2 levers	Reversed locking hoods, side entry, with 2 levers	Covers for double locking system
 <p>SC- Standard construction</p>  <p>HC- High construction. With threaded fitting part No. "0"</p>  <p>HC- High construction. Without threaded fitting part No. "5" For IP68 cable glands</p>	 <p>With threaded fitting part No. "0"</p>  <p>Without threaded fitting part No. "5" For IP68 cable glands</p> <p>HC - High construction</p>	 <p>SC- Standard construction</p>  <p>HC- High construction. With threaded fitting part No. "0"</p>  <p>HC- High construction. Without threaded fitting part No. "5" For IP68 cable glands</p>	<p>With 4 pegs</p>  <p>With 2 levers and gasket</p> 





Type	Thread	Part No.	Type	Thread	Part No.	Type	Thread	Part No.	Locking	Thread	Part No.
SC - Standard construction	M 25	7832.4647.0	HC- High construction With threaded fitting	M 25	7832.4656.0	SC - Standard construction	M 25	7832.4661.0	With 4 pegs		7832.4671.0
	M 32	7832.4648.0		M 32	7832.4657.0		M 32	7832.4662.0	With 2 levers and gasket		7832.4672.0
	Pg 21	7832.4649.0		Pg 21	7832.4658.0		Pg 21	7832.4663.0			
HC- High construction With threaded fitting	M 25	7832.4651.0	HC- High construction Without threaded fitting For IP68 cable glands	M 25	7832.4656.5	HC- High construction With threaded fitting	M 25	7832.4665.0	Covers for reversed double locking system		
	M 32	7832.4652.0		M 32	7832.4657.5		M 32	7832.4666.0			
	Pg 21	7832.4653.0		Pg 21	7832.4658.5		Pg 21	7832.4667.0			
HC- High construction Without threaded fitting For IP68 cable glands	Pg 29	7832.4654.0	Pg 29	7832.4659.5	HC- High construction Without threaded fitting For IP68 cable glands	Pg 29	7832.4668.0	 			
	M 25	7832.4651.5	M 25	7832.4665.5		M 25	7832.4665.5				
	M 32	7832.4652.5	M 32	7832.4666.5		M 32	7832.4666.5				
	Pg 21	7832.4653.5				Pg 21	7832.4667.5				
	Pg 29	7832.4654.5				Pg 29	7832.4668.5				
									Locking		Part No.
									With 4 pegs and gasket		7832.4673.0
									With 2 levers without gasket		7832.4674.0





Type: STD for inserts size 32A, «66x40» S-A, S-D series





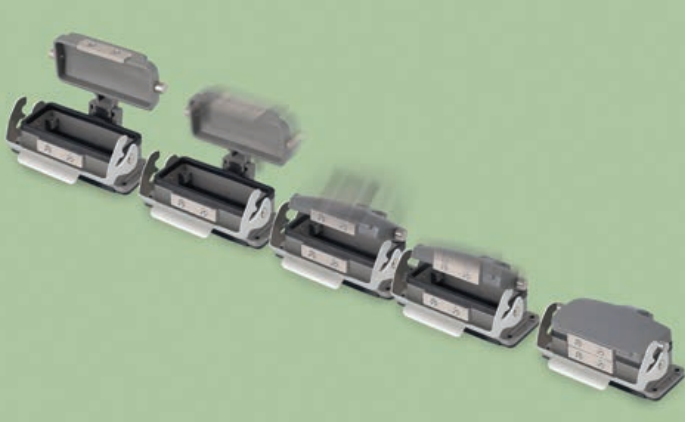







For more technical details and STD-HV, HE, HE-HV, EMC types, please consult the Westec General Catalogue







Accessories, cable glands and tools see page: 42 ÷ 51





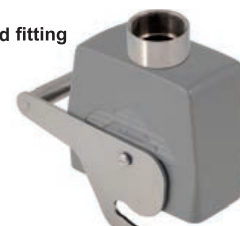

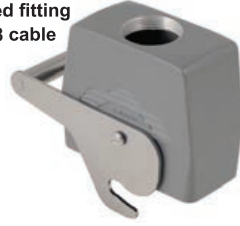
Surface mounting housings			Surface mounting housings with cover			Surface mounting housings			Surface mounting housings with cover		
											
						HC - High construction			HC - High construction		
Size	Thread	Part No.	Size	Thread	Part No.	Size	Thread	Part No.	Size	Thread	Part No.
6B «44 x 27»	M 20	7806.6351.0	6B «44 x 27»	M 20	7806.6361.0	6B «44 x 27»	M 25x2	7806.7150.0	6B «44 x 27»	M 25x2	7806.7264.0
6B «44 x 27»	M 20X2	7806.6352.0	6B «44 x 27»	M 20X2	7806.6362.0	6B «44 x 27»	M 32	7806.7151.0	6B «44 x 27»	M 32	7806.7265.0
6B «44 x 27»	Pg 16	7806.6301.0	6B «44 x 27»	Pg 16	7806.6311.0	6B «44 x 27»	M 32X2	7806.7152.0	6B «44 x 27»	M 32X2	7806.7266.0
6B «44 x 27»	Pg 16X2	7806.6302.0	6B «44 x 27»	Pg 16X2	7806.6312.0	6B «44 x 27»	M 40	7806.7153.0	6B «44 x 27»	M 40	7806.7267.0
10B «57 x 27»	M 20	7810.6353.0	10B «57 x 27»	M 20	7810.6363.0	6B «44 x 27»	M 40X2	7806.7154.0	6B «44 x 27»	M 40X2	7806.7268.0
10B «57 x 27»	M 20X2	7810.6354.0	10B «57 x 27»	M 20X2	7810.6364.0	6B «44 x 27»	Pg 21	7806.7155.0	6B «44 x 27»	Pg 21	7806.7269.0
10B «57 x 27»	Pg 16	7810.6303.0	10B «57 x 27»	Pg 16	7810.6313.0	6B «44 x 27»	Pg 21X2	7806.7156.0	6B «44 x 27»	Pg 21X2	7806.7270.0
10B «57 x 27»	Pg 16X2	7810.6304.0	10B «57 x 27»	Pg 16X2	7810.6314.0	6B «44 x 27»	Pg 29	7806.7157.0	6B «44 x 27»	Pg 29	7806.7271.0
16B «77 x 27»	M 25	7816.6355.0	16B «77 x 27»	M 25	7816.6365.0	6B «44 x 27»	Pg 29X2	7806.7158.0	6B «44 x 27»	Pg 29X2	7806.7272.0
16B «77 x 27»	M 25X2	7816.6356.0	16B «77 x 27»	M 25X2	7816.6366.0	10B «57 x 27»	M 25x2	7810.7159.0	10B «57 x 27»	M 25x2	7810.7273.0
16B «77 x 27»	Pg 21	7816.6305.0	16B «77 x 27»	Pg 21	7816.6315.0	10B «57 x 27»	M 32	7810.7160.0	10B «57 x 27»	M 32	7810.7274.0
16B «77 x 27»	Pg 21X2	7816.6306.0	16B «77 x 27»	Pg 21X2	7816.6316.0	10B «57 x 27»	M 32X2	7810.7161.0	10B «57 x 27»	M 32X2	7810.7275.0
24B «104 x 27»	M 25	7824.6357.0	24B «104 x 27»	M 25	7824.6367.0	10B «57 x 27»	M 40	7810.7162.0	10B «57 x 27»	M 40	7810.7276.0
24B «104 x 27»	M 25X2	7824.6358.0	24B «104 x 27»	M 25X2	7824.6368.0	10B «57 x 27»	M 40X2	7810.7163.0	10B «57 x 27»	M 40X2	7810.7277.0
24B «104 x 27»	Pg 21	7824.6307.0	24B «104 x 27»	Pg 21	7824.6317.0	10B «57 x 27»	Pg 21	7810.7164.0	10B «57 x 27»	Pg 21	7810.7278.0
24B «104 x 27»	Pg 21X2	7824.6308.0	24B «104 x 27»	Pg 21X2	7824.6318.0	10B «57 x 27»	Pg 21X2	7810.7165.0	10B «57 x 27»	Pg 21X2	7810.7279.0
32B «77 x 62»	M 40	7832.6380.0	32B «77 x 62»	M 40	7832.6382.0	10B «57 x 27»	Pg 29	7810.7166.0	10B «57 x 27»	Pg 29	7810.7280.0
32B «77 x 62»	M 40X2	7832.6381.0	32B «77 x 62»	M 40X2	7832.6383.0	10B «57 x 27»	Pg 29X2	7810.7167.0	10B «57 x 27»	Pg 29X2	7810.7281.0
32B «77 x 62»	M 50	7832.6359.0	32B «77 x 62»	M 50	7832.6369.0	16B «77 x 27»	M 25x2	7816.7168.0	16B «77 x 27»	M 25x2	7816.7282.0
32B «77 x 62»	M 50X2	7832.6360.0	32B «77 x 62»	M 50X2	7832.6370.0	16B «77 x 27»	M 32	7816.7169.0	16B «77 x 27»	M 32	7816.7283.0
32B «77 x 62»	Pg 29	7832.6330.0	32B «77 x 62»	Pg 29	7832.6334.0	16B «77 x 27»	M 32X2	7816.7170.0	16B «77 x 27»	M 32X2	7816.7284.0
32B «77 x 62»	Pg 29X2	7832.6331.0	32B «77 x 62»	Pg 29X2	7832.6335.0	16B «77 x 27»	M 40	7816.7171.0	16B «77 x 27»	M 40	7816.7285.0
32B «77 x 62»	Pg 36	7832.6309.0	32B «77 x 62»	Pg 36	7832.6319.0	16B «77 x 27»	M 40X2	7816.7172.0	16B «77 x 27»	M 40X2	7816.7286.0
32B «77 x 62»	Pg 36X2	7832.6310.0	32B «77 x 62»	Pg 36X2	7832.6320.0	16B «77 x 27»	Pg 21	7816.7173.0	16B «77 x 27»	Pg 21	7816.7287.0
32B «77 x 62»	Pg 42 ◊	7832.6332.0	32B «77 x 62»	Pg 42 ◊	7832.6336.0	16B «77 x 27»	Pg 21X2	7816.7174.0	16B «77 x 27»	Pg 21X2	7816.7288.0
32B «77 x 62»	Pg 42X2 ◊	7832.6333.0	32B «77 x 62»	Pg 42X2 ◊	7832.6337.0	16B «77 x 27»	Pg 29	7816.7175.0	16B «77 x 27»	Pg 29	7816.7289.0
48B «104 x 62»	M 32X2	7848.7429.0	48B «104 x 62»	M 32X2	7848.7433.0	16B «77 x 27»	Pg 29X2	7816.7176.0	16B «77 x 27»	Pg 29X2	7816.7290.0
48B «104 x 62»	M 40X2	7848.7430.0	48B «104 x 62»	M 40X2	7848.6386.0	24B «104 x 27»	M 32	7824.7178.0	24B «104 x 27»	M 32	7824.7292.0
48B «104 x 62»	M 50X2	7848.7431.0	48B «104 x 62»	M 50X2	7848.6371.0	24B «104 x 27»	M 32X2	7824.7179.0	24B «104 x 27»	M 32X2	7824.7293.0
48B «104 x 62»	Pg 29X2	7848.7530.0	48B «104 x 62»	Pg 29X2	7848.6342.0	24B «104 x 27»	M 40	7824.7180.0	24B «104 x 27»	M 40	7824.7294.0
48B «104 x 62»	Pg 36X2	7848.7531.0	48B «104 x 62»	Pg 36X2	7848.6321.0	24B «104 x 27»	M 40X2	7824.7181.0	24B «104 x 27»	M 40X2	7824.7295.0
						24B «104 x 27»	Pg 21	7824.7182.0	24B «104 x 27»	Pg 21	7824.7296.0
						24B «104 x 27»	Pg 21X2	7824.7183.0	24B «104 x 27»	Pg 21X2	7824.7297.0
						24B «104 x 27»	Pg 29	7824.7184.0	24B «104 x 27»	Pg 29	7824.7298.0
						24B «104 x 27»	Pg 29X2	7824.7185.0	24B «104 x 27»	Pg 29X2	7824.7299.0
◊: With enlarger Pg36/Pg42 Type: STD for inserts up to 500V S-D, S-DD, S-E, S-ES, S-ESHV, S-EE, S-HSB, S-K, S-M series			 us, Type 4/4x/12 			For more technical details and STD-HV, HE, HE-HV, EMC types, please consult the Westec General Catalogue			Accessories, cable glands and tools see page: 42 ÷ 51		

Housing with automatic cover	Surface mounting housing with automatic cover			Surface mounting housing with automatic cover			
	 <p>PATENTED</p>			 <p>HC - High construction PATENTED</p>			
Technical characteristics	Size	Thread	Part No.	Size	Thread	Part No.	
<p>The housing are provided with a special closing system that allows the fastening of the cover and to achieve the IP66 degree fully automatically.</p> <p>IP69K protection degree with lever.</p> <p>When the operator disconnects the mobile connector from the machine for any reason, transport, maintenance, cleaning etc., shall protect the insert of the fixed connector applying and manually locking the cover by the lever of the mechanical locking system: this to avoid that the further operations will cause the damage of the fixed connector and of the electrical equipment if the bulkhead housing are used.</p> <p>The new Westec housings with automatic cover protect the fixed connectors and the electrical equipments on which they are assembled fully automatically: just when the mobile connector is disconnected.</p> <p>The fastening of cover is obtained with a combination of a magnetic and a mechanical mechanism that permit the tight closing of the cover.</p> <p>The opening of the cover is facilitated by pushing the lever in the opposite direction.</p> <p>These housings can be mated with all mobile enclosures with single locking system with one lever.</p> <p>They are also compatible with the metal hoods made by other makers though we guarantee the best performance and the precise conformity with the Standards when Westec inserts, enclosures and cable glands are used.</p> <p>We suggest to verify the use near components sensible to strong magnetic fields.</p> <p>PATENTED</p>	<p>6B «44 x 27» M 20 7806.7251.0</p> <p>6B «44 x 27» M 20X2 7806.7252.0</p> <p>6B «44 x 27» Pg 16 7806.7211.0</p> <p>6B «44 x 27» Pg 16X2 7806.7212.0</p> <p>10B «57x 27» M 20 7810.7253.0</p> <p>10B «57x 27» M 20X2 7810.7254.0</p> <p>10B «57x 27» Pg 16 7810.7213.0</p> <p>10B «57x 27» Pg 16X2 7810.7214.0</p> <p>16B «77x 27» M 25 7816.7255.0</p> <p>16B «77x 27» M 25X2 7816.7256.0</p> <p>16B «77x 27» Pg 21 7816.7215.0</p> <p>16B «77x 27» Pg 21X2 7816.7216.0</p> <p>24B «104x27» M 25 7824.7257.0</p> <p>24B «104x27» M 25X2 7824.7258.0</p> <p>24B «104x27» Pg 21 7824.7217.0</p> <p>24B «104x27» Pg 21X2 7824.7218.0</p>			<p>6B «44x27» M25x2 7806.7220.0</p> <p>6B «44x27» M 32 7806.7221.0</p> <p>6B «44x27» M 32X2 7806.7222.0</p> <p>6B «44x27» M 40 7806.7223.0</p> <p>6B «44x27» M 40X2 7806.7224.0</p> <p>6B «44x27» Pg 21 7806.7225.0</p> <p>6B «44x27» Pg 21X2 7806.7226.0</p> <p>6B «44x27» Pg 29 7806.7227.0</p> <p>6B «44x27» Pg 29X2 7806.7228.0</p> <p>10B «57x27» M25x2 7810.7229.0</p> <p>10B «57x27» M 32 7810.7230.0</p> <p>10B «57x27» M 32X2 7810.7231.0</p> <p>10B «57x27» M 40 7810.7232.0</p> <p>10B «57x27» M 40X2 7810.7233.0</p> <p>10B «57x27» Pg 21 7810.7234.0</p> <p>10B «57x27» Pg 21X2 7810.7235.0</p> <p>10B «57x27» Pg 29 7810.7236.0</p> <p>10B «57x27» Pg 29X2 7810.7237.0</p> <p>16B «77x27» M25x2 7816.7238.0</p> <p>16B «77x27» M 32 7816.7239.0</p> <p>16B «77x27» M 32X2 7816.7240.0</p> <p>16B «77x27» M 40 7816.7241.0</p> <p>16B «77x27» M 40X2 7816.7242.0</p> <p>16B «77x27» Pg 21 7816.7243.0</p> <p>16B «77x27» Pg 21X2 7816.7244.0</p> <p>16B «77x27» Pg 29 7816.7245.0</p> <p>16B «77x27» Pg 29X2 7816.7246.0</p> <p>24B «104x27» M 32 7824.7247.0</p> <p>24B «104x27» M 32X2 7824.7248.0</p> <p>24B «104x27» M 40 7824.7249.0</p> <p>24B «104x27» M 40X2 7824.7250.0</p> <p>24B «104x27» Pg 21 7824.7201.0</p> <p>24B «104x27» Pg 21X2 7824.7202.0</p> <p>24B «104x27» Pg 29 7824.7203.0</p> <p>24B «104x27» Pg 29X2 7824.7204.0</p>			
<p>Type: STD for inserts up to 500V S-D, S-DD, S-E, S-ES, S-ESHV, S-EE, S-HSB, S-K, S-M series</p>				<p>For more technical details and STD-HV, HE, HE-HV, EMC types, please consult the Westec General Catalogue</p>			<p>Accessories, cable glands and tools see page: 42 + 51</p>

Bulkhead mounting housings			Hoods with 2 pegs for 1 lever			Hoods top entry with 2 pegs for 1 lever			Hoods top entry with 2 pegs for 1 lever		
						 <p>HC - High construction</p>			 <p>HC - High construction</p>		
Size		Part No.	Size	Thread	Part No.	Size	Thread	Part No.	Size	Thread	Part No.
6B «44 x 27»		7806.6401.0	6B «44 x 27»	M 20	7806.6553.0	6B «44 x 27»	M 25	7806.6449.0	6B «44 x 27»	M 25	7806.6449.5
10B «57 x 27»		7810.6403.0	6B «44 x 27»	M 25	7806.6554.0	6B «44 x 27»	M 32	7806.6450.0	6B «44 x 27»	M 32	7806.6450.5
16B «77 x 27»		7816.6405.0	6B «44 x 27»	M 25	7806.6554.0	6B «44 x 27»	Pg 21	7806.6427.0	6B «44 x 27»	Pg 21	7806.6427.5
24B «104 x 27»		7824.6407.0	6B «44 x 27»	Pg 13.5	7806.6503.0	6B «44 x 27»	Pg 29	7806.6428.0	6B «44 x 27»	Pg 29	7806.6428.5
32B «77 x 62»		7832.6409.0	6B «44 x 27»	Pg 16	7806.6504.0	10B «57 x 27»	M 32	7810.6451.0	10B «57 x 27»	M 32	7810.6451.5
48B «104x62»		7848.7440.0	10B «57 x 27»	M 20	7810.6556.0	10B «57 x 27»	M 40	7810.6452.0	10B «57 x 27»	M 40	7810.6452.5
			10B «57 x 27»	M 25	7810.6593.0	10B «57 x 27»	Pg 21	7810.6429.0	10B «57 x 27»	Pg 21	7810.6429.5
			10B «57 x 27»	Pg 16	7810.6506.0	10B «57 x 27»	Pg 29	7810.6430.0	10B «57 x 27»	Pg 29	7810.6430.5
		With cover	16B «77 x 27»	M 25	7816.6558.0	16B «77 x 27»	M 32	7816.6453.0	16B «77 x 27»	M 32	7816.6453.5
6B «44 x 27»		7806.6402.0	16B «77 x 27»	M 32	7816.6547.0	16B «77 x 27»	M 40	7816.6454.0	16B «77 x 27»	M 40	7816.6454.5
10B «57 x 27»		7810.6404.0	16B «77 x 27»	Pg 21	7816.6508.0	16B «77 x 27»	Pg 21	7816.6431.0	16B «77 x 27»	Pg 21	7816.6431.5
16B «77 x 27»		7816.6406.0	16B «77 x 27»	Pg 29	7816.6548.0	16B «77 x 27»	Pg 29	7816.6432.0	16B «77 x 27»	Pg 29	7816.6432.5
24B «104 x 27»		7824.6408.0	24B «104 x 27»	M 25	7824.6560.0	24B «104 x 27»	M 32	7824.6455.0	24B «104 x 27»	M 32	7824.6455.5
32B «77 x 62»		7832.6410.0	24B «104 x 27»	M 32	7824.6924.0	24B «104 x 27»	M 40	7824.6456.0	24B «104 x 27»	M 40	7824.6456.5
48B «104x62»		7848.6411.0	24B «104 x 27»	Pg 21	7824.6510.0	24B «104 x 27»	Pg 21	7824.6433.0	24B «104 x 27»	Pg 21	7824.6433.5
			24B «104 x 27»	Pg 29	7824.6613.0	24B «104 x 27»	Pg 29	7824.6434.0	24B «104 x 27»	Pg 29	7824.6434.5
		With automatic cover	Side entry			32B «77 x 62»	M 32	7832.7135.0	32B «77 x 62»	M 32	7832.7135.5
6B «44x27»		7806.7205.0	6B «44 x 27»	M 20	7806.6551.0	32B «77 x 62»	M 40	7832.6562.0	32B «77 x 62»	M 40	7832.6562.5
10B «57x27»		7810.7206.0	6B «44 x 27»	M 25	7806.6552.0	32B «77 x 62»	Pg 29	7832.7134.0	32B «77 x 62»	Pg 29	7832.7134.5
16B «77x27»		7816.7207.0	6B «44 x 27»	Pg 13.5	7806.6501.0	32B «77 x 62»	Pg 36	7832.6512.0	32B «77 x 62»	Pg 36	7832.6512.5
24B «104x27»		7824.7208.0	6B «44 x 27»	Pg 16	7806.6502.0	48B «104 x 62»	M 32	7848.6566.0	48B «104 x 62»	M 32	7848.6566.5
			10B «57 x 27»	M 20	7810.6555.0	48B «104 x 62»	M 40	7848.6567.0	48B «104 x 62»	M 40	7848.6567.5
			10B «57 x 27»	M 25	7810.6594.0	48B «104 x 62»	M 50	7848.6568.0	48B «104 x 62»	M 50	7848.6568.5
			10B «57 x 27»	Pg 16	7810.6505.0	48B «104 x 62»	Pg 29	7848.6516.0	48B «104 x 62»	Pg 29	7848.6516.5
			16B «77 x 27»	M 25	7816.6557.0	48B «104 x 62»	Pg 36	7848.6517.0	48B «104 x 62»	Pg 36	7848.6517.5
			16B «77 x 27»	M 32	7816.6549.0	48B «104 x 62»	Pg 42	7848.6518.0	48B «104 x 62»	Pg 42	7848.6518.5
			16B «77 x 27»	Pg 21	7816.6507.0						Without cable entry
			16B «77 x 27»	Pg 29	7816.6550.0				6B «44 x 27»		7806.6941.0
			24B «104 x 27»	M 25	7824.6559.0				10B «57 x 27»		7810.7007.0
			24B «104 x 27»	M 32	7824.6925.0				16B «77 x 27»		7816.7019.0
			24B «104 x 27»	Pg 21	7824.6509.0				24B «104 x 27»		7824.7043.0
			24B «104 x 27»	Pg 29	7824.6614.0				32B «77 x 62»		7832.7148.0
									48B «104x62»		7848.7149.0
Type: STD for inserts up to 500V S-D, S-DD, S-E, S-ES, S-ESHV, S-EE, S-HSB, S-K, S-M series						For more technical details and STD-HV, HE, HE-HV, EMC types, please consult the Westec General Catalogue			Accessories, cable glands and tools see page: 42 + 51		

Hoods side entry with 2 pegs for 1 lever			Hoods side entry with 2 pegs for 1 lever			Hoods top entry with 1 lever and gasket			Hoods top entry with 1 lever and gasket		
<p>With threaded fitting</p>  <p>HC - High construction</p>			<p>Without threaded fitting For IP68 cable glands</p>  <p>HC - High construction</p>						<p>With threaded fitting</p>  <p>Without threaded fitting For IP68 cable glands</p>  <p>HC - High construction</p>		
Size	Thread	Part No.	Size	Thread	Part No.	Size	Thread	Part No.	Size	Thread	Part No.
6B «44 x 27»	M 25	7806.6491.0	6B «44 x 27»	M 25	7806.6491.5	6B «44 x 27»	M 20	7806.6592.0	10B «57 x 27» 10B «57 x 27» 10B «57 x 27» 10B «57 x 27»	M 25 M 32 Pg 21 Pg 29	With threaded fitting 7810.7008.0 7810.7009.0 7810.7107.0 7810.7108.0
6B «44 x 27»	M 32	7806.6492.0	6B «44 x 27»	M 32	7806.6492.5	6B «44 x 27»	M 25	7806.6581.0			
6B «44 x 27»	Pg 21	7806.6477.0	6B «44 x 27»	Pg 21	7806.6477.5	6B «44 x 27»	Pg 13,5	7806.6542.0			
6B «44 x 27»	Pg 29	7806.6478.0	6B «44 x 27»	Pg 29	7806.6478.5	6B «44 x 27»	Pg 16	7806.6531.0			
10B «57 x 27»	M 32	7810.6493.0	10B «57 x 27»	M 32	7810.6493.5	10B «57 x 27»	M 25	7810.6582.0	16B «77 x 27» 16B «77 x 27» 16B «77 x 27» 16B «77 x 27»	M 25 M 32 Pg 21 Pg 29	7816.6461.0 7816.6462.0 7816.6439.0 7816.6440.0
10B «57 x 27»	M 40	7810.6494.0	10B «57 x 27»	M 40	7810.6494.5	10B «57 x 27»	Pg 16	7810.6532.0			
10B «57 x 27»	Pg 21	7810.6479.0	10B «57 x 27»	Pg 21	7810.6479.5	16B «77 x 27»	M 25	7816.6583.0			
10B «57 x 27»	Pg 29	7810.6480.0	10B «57 x 27»	Pg 29	7810.6480.5	16B «77 x 27»	Pg 21	7816.6533.0			
16B «77 x 27»	M 32	7816.6495.0	16B «77 x 27»	M 32	7816.6495.5	24B «104 x 27» 24B «104 x 27» 24B «104 x 27» 24B «104 x 27»	M 32 Pg 21 Pg 29	7824.6584.0 7824.6534.0 7824.7147.0	24B «104 x 27» 24B «104 x 27» 24B «104 x 27» 24B «104 x 27»	M 25 M 32 Pg 21 Pg 29	7824.6463.0 7824.6464.0 7824.6441.0 7824.6442.0
16B «77 x 27»	M 40	7816.6496.0	16B «77 x 27»	M 40	7816.6496.5						
16B «77 x 27»	Pg 21	7816.6481.0	16B «77 x 27»	Pg 21	7816.6481.5						
16B «77 x 27»	Pg 29	7816.6482.0	16B «77 x 27»	Pg 29	7816.6482.5						
24B «104 x 27»	M 32	7824.6497.0	24B «104 x 27»	M 32	7824.6497.5	32B «77 x 62» 32B «77 x 62»	M 40 Pg 36	7832.6585.0 7832.6535.0	Without threaded fitting	M 25 M 32 Pg 21 Pg 29	7810.7008.5 7810.7009.5 7810.7107.5 7810.7108.5
24B «104 x 27»	M 40	7824.6498.0	24B «104 x 27»	M 40	7824.6498.5						
24B «104 x 27»	Pg 21	7824.6483.0	24B «104 x 27»	Pg 21	7824.6483.5						
24B «104 x 27»	Pg 29	7824.6484.0	24B «104 x 27»	Pg 29	7824.6484.5						
32B «77 x 62»	M 32	7832.7137.0	32B «77 x 62»	M 32	7832.7137.5	10B «57 x 27» 10B «57 x 27» 10B «57 x 27» 10B «57 x 27»	M 25 M 32 Pg 21 Pg 29	7816.6461.5 7816.6462.5 7816.6439.5 7816.6440.5	M 25 M 32 Pg 21 Pg 29	7824.6463.5 7824.6464.5 7824.6441.5 7824.6442.5	
32B «77 x 62»	M 40	7832.6561.0	32B «77 x 62»	M 40	7832.6561.5						
32B «77 x 62»	Pg 21	7832.7139.0	32B «77 x 62»	Pg 21	7832.7139.5						
32B «77 x 62»	Pg 29	7832.7136.0	32B «77 x 62»	Pg 29	7832.7136.5						
32B «77 x 62»	Pg 36	7832.6511.0	32B «77 x 62»	Pg 36	7832.6511.5	16B «77 x 27»	M 25	7816.6461.5	24B «104 x 27» 24B «104 x 27» 24B «104 x 27» 24B «104 x 27»	M 25 M 32 Pg 21 Pg 29	7824.6463.5 7824.6464.5 7824.6441.5 7824.6442.5
48B «104 x 62»	M 32	7848.6563.0	48B «104 x 62»	M 32	7848.6563.5						
48B «104 x 62»	M 40	7848.6564.0	48B «104 x 62»	M 40	7848.6564.5						
48B «104 x 62»	M 50	7848.6565.0	48B «104 x 62»	M 50	7848.6565.5						
48B «104 x 62»	Pg 29	7848.6513.0	48B «104 x 62»	Pg 29	7848.6513.5	16B «77 x 27»	M 25	7816.6461.5	32B «77 x 62» 32B «77 x 62»	M 40 Pg 36	7832.6585.5 7832.6535.5
48B «104 x 62»	Pg 36	7848.6514.0	48B «104 x 62»	Pg 36	7848.6514.5						
48B «104 x 62»	Pg 42	7848.6515.0	48B «104 x 62»	Pg 42	7848.6515.5						
48B «104 x 62»	Pg 42	7848.6515.0	48B «104 x 62»	Pg 42	7848.6515.5						
<p>Type: STD for inserts up to 500V S-D, S-DD, S-E, S-ES, S-ESHV, S-EE, S-HSB, S-K, S-M series</p>			<p>UL us, Type 4/4x/12 CE (RoHS)</p>			<p>For more technical details and STD-HV, HE, HE-HV, EMC types, please consult the Westec General Catalogue</p>			<p>Accessories, cable glands and tools see page: 42 + 51</p>		

Surface mounting housings			Bulkhead mounting housings			Hoods top entry			Hoods side entry		
 HC - High construction						With threaded fitting 			With threaded fitting 		
						Without threaded fitting for IP68 cable gland 			Without threaded fitting for IP68 cable gland 		
						HC - High construction			HC - High construction		
Size	Thread	Part No.	Size		Part No.	Size	Thread	Part No.	Size	Thread	Part No.
6B «44x27»	M25x2	7806.5212.0	6B «44x27»		7806.5270.0			With threaded fitting	6B «44x27»	M 25	7806.5299.0
6B «44x27»	M 32X2	7806.5214.0				6B «44x27»	M 25	7806.5280.0	6B «44x27»	M 32	7806.5300.0
6B «44x27»	M 40X2	7806.5216.0	10B «57x27»		7810.5271.0	6B «44x27»	M 32	7806.5281.0	6B «44x27»	Pg 16	7806.5301.0
6B «44x27»	Pg 21X2	7806.5218.0				6B «44x27»	Pg 21	7806.5282.0	6B «44x27»	Pg 21	7806.5302.0
6B «44x27»	Pg 29X2	7806.5220.0	16B «77x27»		7816.5272.0	6B «44x27»	Pg 29	7806.5283.0	6B «44x27»	Pg 29	7806.5303.0
			24B «104x27»		7824.5273.0	10B «57x27»	M 32	7810.5285.0	10B «57x27»	M 25	7810.5304.0
10B «57x27»	M25x2	7810.5222.0				10B «57x27»	M 40	7810.5286.0	10B «57x27»	M 32	7810.5305.0
10B «57x27»	M 32X2	7810.5224.0				10B «57x27»	Pg 21	7810.5287.0	10B «57x27»	M 40	7810.5306.0
10B «57x27»	M 40X2	7810.5226.0				10B «57x27»	Pg 29	7810.5288.0	10B «57x27»	Pg 21	7810.5307.0
10B «57x27»	Pg 21X2	7810.5228.0				16B «77x27»	M 32	7816.5290.0	16B «77x27»	M 25	7816.5309.0
10B «57x27»	Pg 29X2	7810.5230.0				16B «77x27»	M 40	7816.5291.0	16B «77x27»	M 32	7816.5310.0
						16B «77x27»	Pg 21	7816.5292.0	16B «77x27»	M 40	7816.5311.0
16B «77x27»	M25x2	7816.5232.0				16B «77x27»	Pg 29	7816.5293.0	16B «77x27»	Pg 21	7816.5312.0
16B «77x27»	M 32X2	7816.5234.0				24B «104x27»	M 32	7824.5295.0	24B «104x27»	Pg 29	7816.5313.0
16B «77x27»	M 40X2	7816.5236.0				24B «104x27»	M 40	7824.5296.0	24B «104x27»	M 25	7824.5314.0
16B «77x27»	Pg 21X2	7816.5238.0				24B «104x27»	Pg 21	7824.5297.0	24B «104x27»	M 32	7824.5315.0
16B «77x27»	Pg 29X2	7816.5240.0				24B «104x27»	Pg 29	7824.5298.0	24B «104x27»	M 40	7824.5316.0
									24B «104x27»	Pg 21	7824.5317.0
									24B «104x27»	Pg 29	7824.5318.0
								Without threaded fitting			Without threaded fitting
24B «104x27»	M 32X2	7824.5244.0				6B «44x27»	M 25	7806.5280.5	6B «44x27»	M 25	7806.5299.5
24B «104x27»	M 40X2	7824.5246.0				6B «44x27»	M 32	7806.5281.5	6B «44x27»	M 32	7806.5300.5
24B «104x27»	Pg 21X2	7824.5248.0				6B «44x27»	Pg 21	7806.5282.5	6B «44x27»	Pg 16	7806.5301.5
24B «104x27»	Pg 29X2	7824.5250.0				6B «44x27»	Pg 29	7806.5283.5	6B «44x27»	Pg 21	7806.5302.5
									6B «44x27»	Pg 29	7806.5303.5
						10B «57x27»	M 32	7810.5285.5	10B «57x27»	M 25	7810.5304.5
						10B «57x27»	M 40	7810.5286.5	10B «57x27»	M 32	7810.5305.5
						10B «57x27»	Pg 21	7810.5287.5	10B «57x27»	M 40	7810.5306.5
						10B «57x27»	Pg 29	7810.5288.5	10B «57x27»	Pg 21	7810.5307.5
						16B «77x27»	M 32	7816.5290.5	16B «77x27»	Pg 29	7810.5308.5
						16B «77x27»	M 40	7816.5291.5	16B «77x27»	M 25	7816.5309.5
						16B «77x27»	Pg 21	7816.5292.5	16B «77x27»	M 32	7816.5310.5
						16B «77x27»	Pg 29	7816.5293.5	16B «77x27»	M 40	7816.5311.5
						24B «104x27»	M 32	7824.5295.5	16B «77x27»	Pg 21	7816.5312.5
						24B «104x27»	M 40	7824.5296.5	16B «77x27»	Pg 29	7816.5313.5
						24B «104x27»	Pg 21	7824.5297.5	24B «104x27»	M 25	7824.5314.5
						24B «104x27»	Pg 29	7824.5298.5	24B «104x27»	M 32	7824.5315.5
									24B «104x27»	M 40	7824.5316.5
									24B «104x27»	Pg 21	7824.5317.5
									24B «104x27»	Pg 29	7824.5318.5
Type: STD for inserts up to 500V S-D, S-DD, S-E, S-ES, S-ESHV, S-EE, S-HSB, S-K, S-M series						For more technical details and STD-HV, HE, HE-HV, EMC types, please consult the Westec General Catalogue			Accessories, cable glands and tools see page: 42 ÷ 51		

Surface mounting housings			Surface mounting housings			Bottom entry surface mounting housings			Bulkhead mounting housings		
						With IP68 cable gland  					
			HC - High construction			HC - High construction					
Size	Thread	Part No.	Size	Thread	Part No.	Size	Thread	Part No.	Size	Part No.	
10B «57x27»	M 20	7810.6372.0	10B «57x27»	M 25	7810.7458.0	10B «57x27»	M 20	7810.7562.0	10B «57x27»		7810.6412.0
10B «57x27»	M 20X2	7810.6373.0	10B «57x27»	M 25x2	7810.7459.0	10B «57x27»	M 25	7810.7563.0	16B «77x27»		7816.6413.0
10B «57x27»	Pg 16	7810.6322.0	10B «57x27»	M 32	7810.7460.0	16B «77x27»	M 20	7816.7564.0	24B «104x27»		7824.6414.0
10B «57x27»	Pg 16X2	7810.6323.0	10B «57x27»	M 32X2	7810.7461.0	16B «77x27»	M 25	7816.7565.0	32B «77x62»		7832.6415.0
16B «77x27»	M 25	7816.6374.0	10B «57x27»	M 40	7810.7462.0	24B «104x27»	M 20	7824.7566.0			
16B «77x27»	M 25X2	7816.6375.0	10B «57x27»	M 40X2	7810.7463.0	24B «104x27»	M 25	7824.7567.0			
16B «77x27»	Pg 21	7816.6324.0	10B «57x27»	Pg 21	7810.7464.0	32B «77x62»	M 32	7832.7568.0			
16B «77x27»	Pg 21X2	7816.6325.0	10B «57x27»	Pg 21X2	7810.7465.0	32B «77x62»	M 40	7832.7569.0			
24B «104x27»	M 25	7824.6376.0	10B «57x27»	Pg 29	7810.7466.0	32B «77x62»	M 50	7832.7570.0			
24B «104x27»	M 25X2	7824.6377.0	10B «57x27»	Pg 29X2	7810.7467.0						
24B «104x27»	Pg 21	7824.6326.0	16B «77x27»	M 25x2	7816.7468.0						
24B «104x27»	Pg 21X2	7824.6327.0	16B «77x27»	M 32	7816.7469.0						
32B «77x62»	M 40	7832.6384.0	16B «77x27»	M 32X2	7816.7470.0						
32B «77x62»	M 40X2	7832.6385.0	16B «77x27»	M 40	7816.7471.0	10B «57x27»	M 25	7810.7573.0			
32B «77x62»	M 50	7832.6378.0	16B «77x27»	M 40X2	7816.7472.0	10B «57x27»	M 32	7810.7574.0			
32B «77x62»	M 50X2	7832.6379.0	16B «77x27»	Pg 21	7816.7473.0	16B «77x27»	M 25	7816.7575.0			
32B «77x62»	Pg 29	7832.6338.0	16B «77x27»	Pg 21X2	7816.7474.0	16B «77x27»	M 32	7816.7576.0			
32B «77x62»	Pg 29X2	7832.6339.0	16B «77x27»	Pg 29	7816.7475.0	24B «104x27»	M 25	7824.7577.0			
32B «77x62»	Pg 36	7832.6328.0	16B «77x27»	Pg 29X2	7816.7476.0	24B «104x27»	M 32	7824.7578.0			
32B «77x62»	Pg 36X2	7832.6329.0	24B «104x27»	M 32	7824.7478.0						
32B «77x62»	Pg 42	7832.6340.0	24B «104x27»	M 32X2	7824.7479.0						
32B «77x62»	Pg 42X2	7832.6341.0	24B «104x27»	M 40	7824.7480.0						
			24B «104x27»	M 40X2	7824.7481.0						
			24B «104x27»	Pg 21	7824.7482.0						
			24B «104x27»	Pg 21X2	7824.7483.0						
			24B «104x27»	Pg 29	7824.7484.0						
			24B «104x27»	Pg 29X2	7824.7485.0						
Type: STD for inserts up to 500V S-D, S-DD, S-E, S-ES, S-ESHV, S-EE, S-HSB, S-K, S-M series			 us, Type 4/4x/12 			For more technical details and STD-HV, HE, HE-HV, EMC types, please consult the Westec General Catalogue			Accessories, cable glands and tools see page: 42 + 51		

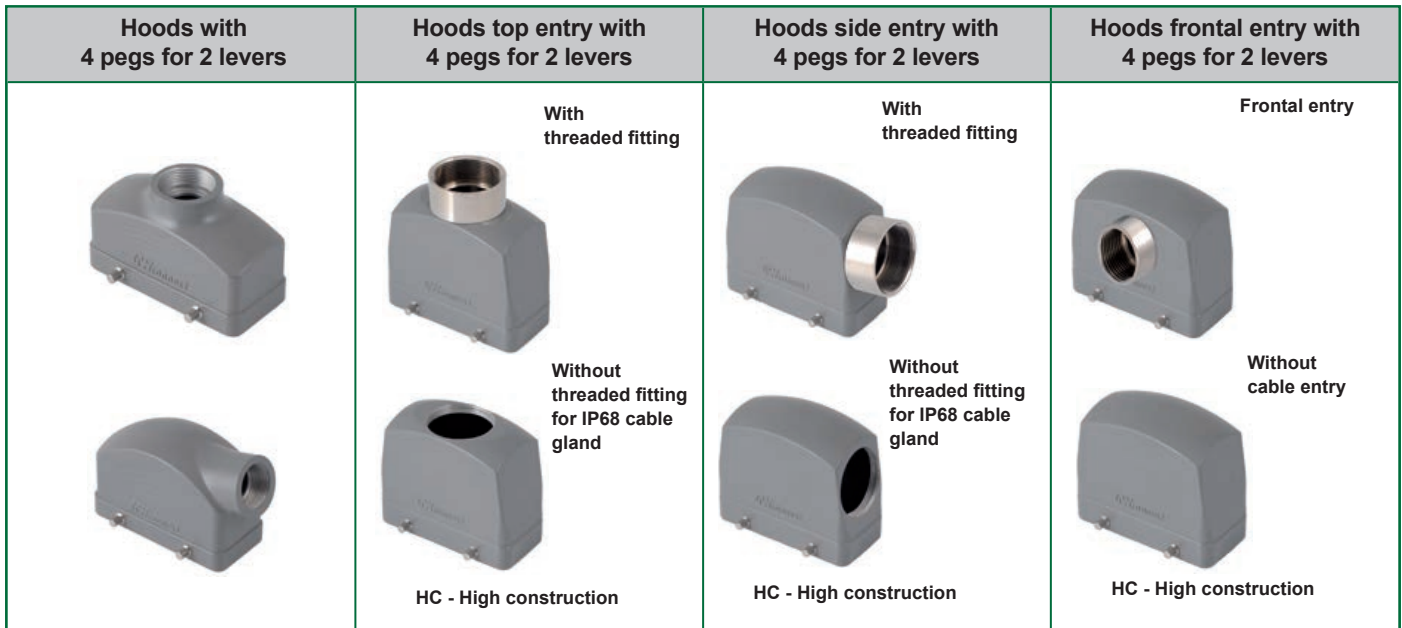







Size	Thread	Part No.	Size	Thread	Part No.	Size	Thread	Part No.	Size	Thread	Part No.
		Top entry			With threaded fitting			With threaded fitting			Frontal entry
10B «57 x 27»	M 20	7810.6570.0	10B «57 x 27»	M 32	7810.6443.0	10B «57 x 27»	M 32	7810.6485.0	10B «57 x 27»	M 20	7810.7011.0
10B «57 x 27»	M 25	7810.6595.0	10B «57 x 27»	M 40	7810.6444.0	10B «57 x 27»	M 40	7810.6486.0	10B «57 x 27»	Pg16	7810.7109.0
10B «57 x 27»	Pg 16	7810.6520.0	10B «57 x 27»	Pg 21	7810.6421.0	10B «57 x 27»	Pg 21	7810.6471.0			
			10B «57 x 27»	Pg 29	7810.6422.0	10B «57 x 27»	Pg 29	7810.6472.0			
16B «77 x 27»	M 25	7816.6572.0	16B «77 x 27»	M 32	7816.6445.0	16B «77 x 27»	M 32	7816.6487.0	16B «77 x 27»	M 25	7816.7021.0
16B «77 x 27»	M 32	7816.6921.0	16B «77 x 27»	M 40	7816.6446.0	16B «77 x 27»	M 40	7816.6488.0	16B «77 x 27»	Pg 21	7816.7113.0
16B «77 x 27»	Pg 21	7816.6522.0	16B «77 x 27»	Pg 21	7816.6423.0	16B «77 x 27»	Pg 21	7816.6473.0			
16B «77 x 27»	Pg 29	7816.6546.0	16B «77 x 27»	Pg 29	7816.6424.0	16B «77 x 27»	Pg 29	7816.6474.0			
24B «104 x 27»	M 25	7824.6574.0	24B «104 x 27»	M 32	7824.6447.0	24B «104 x 27»	M 32	7824.6489.0	24B «104 x 27»	M 25	7824.7032.0
24B «104 x 27»	M 32	7824.6926.0	24B «104 x 27»	M 40	7824.6448.0	24B «104 x 27»	M 40	7824.6490.0	24B «104 x 27»	M 32	7824.7033.0
24B «104 x 27»	Pg 21	7824.6524.0	24B «104 x 27»	Pg 21	7824.6425.0	24B «104 x 27»	Pg 21	7824.6475.0	24B «104 x 27»	Pg 21	7824.7120.0
24B «104 x 27»	Pg 29	7824.6543.0	24B «104 x 27»	Pg 29	7824.6426.0	24B «104 x 27»	Pg 29	7824.6476.0	24B «104 x 27»	Pg 29	7824.7121.0
32B «77 x 62»	M 32	7832.6578.0	32B «77 x 62»	M 32	7832.6578.0	32B «77 x 62»	M 32	7832.6575.0			
32B «77 x 62»	M 40	7832.6579.0	32B «77 x 62»	M 40	7832.6579.0	32B «77 x 62»	M 40	7832.6576.0			
32B «77 x 62»	M 50	7832.6580.0	32B «77 x 62»	M 50	7832.6580.0	32B «77 x 62»	M 50	7832.6577.0			
32B «77 x 62»	Pg 29	7832.6528.0	32B «77 x 62»	Pg 29	7832.6528.0	32B «77 x 62»	Pg 21	7832.7142.0			
32B «77 x 62»	Pg 36	7832.6529.0	32B «77 x 62»	Pg 36	7832.6529.0	32B «77 x 62»	Pg 29	7832.6525.0			
32B «77 x 62»	Pg 42	7832.6530.0	32B «77 x 62»	Pg 42	7832.6530.0	32B «77 x 62»	Pg 36	7832.6526.0			
		Side entry			Without threaded fitting			Without threaded fitting			Without cable entry
10B «57 x 27»	M 20	7810.6569.0				10B «57 x 27»	M 32	7810.6485.5	10B «57 x 27»		7810.7012.0
10B «57 x 27»	M 25	7810.6596.0	10B «57 x 27»	M 32	7810.6443.5	10B «57 x 27»	M 40	7810.6486.5	16B «77 x 27»		7816.7022.0
10B «57 x 27»	Pg 16	7810.6519.0	10B «57 x 27»	M 40	7810.6444.5	10B «57 x 27»	M 40	7810.6487.5	24B «104 x 27»		7824.7034.0
			10B «57 x 27»	Pg 21	7810.6421.5	10B «57 x 27»	Pg 21	7810.6471.5			
			10B «57 x 27»	Pg 29	7810.6422.5	10B «57 x 27»	Pg 29	7810.6472.5	32B «77 x 62»		7832.7048.0
16B «77 x 27»	M 25	7816.6571.0	16B «77 x 27»	M 32	7816.6445.5	16B «77 x 27»	M 32	7816.6487.5			
16B «77 x 27»	M 32	7816.6922.0	16B «77 x 27»	M 40	7816.6446.5	16B «77 x 27»	M 40	7816.6488.5			
16B «77 x 27»	Pg 21	7816.6521.0	16B «77 x 27»	Pg 21	7816.6423.5	16B «77 x 27»	Pg 21	7816.6473.5			
16B «77 x 27»	Pg 29	7816.6545.0	16B «77 x 27»	Pg 29	7816.6424.5	16B «77 x 27»	Pg 29	7816.6474.5			
24B «104 x 27»	M 25	7824.6573.0	24B «104 x 27»	M 32	7824.6447.5	24B «104 x 27»	M 32	7824.6489.5			
24B «104 x 27»	M 32	7824.6927.0	24B «104 x 27»	M 40	7824.6448.5	24B «104 x 27»	M 40	7824.6490.5			
24B «104 x 27»	Pg 21	7824.6523.0	24B «104 x 27»	Pg 21	7824.6425.5	24B «104 x 27»	Pg 21	7824.6475.5			
24B «104 x 27»	Pg 29	7824.6544.0	24B «104 x 27»	Pg 29	7824.6426.5	24B «104 x 27»	Pg 29	7824.6476.5			
32B «77 x 62»	M 32	7832.6578.5	32B «77 x 62»	M 32	7832.6578.5	32B «77 x 62»	M 32	7832.6575.5			
32B «77 x 62»	M 40	7832.6579.5	32B «77 x 62»	M 40	7832.6579.5	32B «77 x 62»	M 40	7832.6576.5			
32B «77 x 62»	M 50	7832.6580.5	32B «77 x 62»	M 50	7832.6580.5	32B «77 x 62»	M 50	7832.6577.5			
32B «77 x 62»	Pg 29	7832.6528.5	32B «77 x 62»	Pg 29	7832.6528.5	32B «77 x 62»	Pg 21	7832.7142.5			
32B «77 x 62»	Pg 36	7832.6529.5	32B «77 x 62»	Pg 36	7832.6529.5	32B «77 x 62»	Pg 29	7832.6525.5			
32B «77 x 62»	Pg 42	7832.6530.5	32B «77 x 62»	Pg 42	7832.6530.5	32B «77 x 62»	Pg 36	7832.6526.5			
32B «77 x 62»			32B «77 x 62»	Pg 42		32B «77 x 62»	Pg 42	7832.6527.5			

Type: STD for inserts up to 500V S-D, S-DD, S-E, S-ES, S-ESHV, S-EE, S-HSB, S-K, S-M series



For more technical details and STD-HV, HE, HE-HV, EMC types, please consult the Westec General Catalogue

Accessories, cable glands and tools see page: 42 + 51

Hoods for ribbon cable with strain relief IP66	Hoods with double top entries 4 pegs for 2 levers	Hoods with double frontal entries 4 pegs for 2 levers	Hoods top entry with 2 levers and gasket
 <p><i>Patent</i></p> <p>HC - High construction</p>	 <p>With threaded fitting</p>  <p>Without threaded fitting for IP68 cable gland</p> <p>HC - High construction</p>	 <p>With threaded fitting</p>  <p>Without threaded fitting for IP68 cable gland</p> <p>HC - High construction</p>	 <p>With threaded fitting</p>  <p>Without threaded fitting for IP68 cable gland</p> <p>HC - High construction</p>







Size	Cable size HxL	Part No.	Size	Thread	Part No.	Size	Thread	Part No.	Size	Thread	Part No.
10B «57 x 27»	3,8-5,1 X 18-22	7810.5361.0			With threaded fitting			With threaded fitting			With threaded fitting
10B «57 x 27»	3,8-5,1 X 27-32	7810.5362.0	10B «57x27»	M 20x2	7810.6610.0	16B «77x27»	M 25x2	7816.6615.0	10B «57 x 27»	M 25	7810.7003.0
			10B «57x27»	Pg13,5x2	7810.6612.0	16B «77x27»	Pg 21x2	7816.6616.0	10B «57 x 27»	M 32	7810.7004.0
			16B «77x27»	M 20x2	7816.6618.0	24B «104x27»	M 25x2	7824.6630.0	10B «57 x 27»	Pg 21	7810.7104.0
16B «77 x 27»	3,8-5,1 X 18-22	7816.5365.0	16B «77x27»	M 25x2	7816.6619.0	24B «104x27»	Pg 21x2	7824.6632.0	10B «57 x 27»	Pg 29	7810.7105.0
16B «77 x 27»	3,8-5,1 X 27-32	7816.5366.0	16B «77x27»	M 16x2	7816.6621.0				16B «77 x 27»	M 25	7816.6457.0
16B «77 x 27»	3,8-5,1 X 42-46	7816.5367.0	16B «77x27»	Pg 16x2	7816.6622.0				16B «77 x 27»	M 32	7816.6458.0
16B «77 x 27»	3,8-5,1 X 48-53	7816.5368.0	24B «104x27»	M 32x2	7824.6625.0	16B «77x27»	M 25x2	7816.6615.5	16B «77 x 27»	Pg 21	7816.6435.0
			24B «104x27»	M 40x2	7824.6626.0	16B «77x27»	Pg 21x2	7816.6616.5	16B «77 x 27»	Pg 29	7816.6436.0
			24B «104x27»	Pg 21x2	7824.6627.0	24B «104x27»	M 25x2	7824.6630.5	32B «77 x 62»	M 32	7832.6589.0
			24B «104x27»	Pg 29x2	7824.6628.0	24B «104x27»	Pg 21x2	7824.6632.5	32B «77 x 62»	M 40	7832.6590.0
					Without threaded fitting				32B «77 x 62»	M 50	7832.6591.0
24B «104 x 27»	3,8-5,1 X 18-22	7824.5370.0	10B «57x27»	M 20x2	7810.6610.5				32B «77 x 62»	Pg 29	7832.6539.0
24B «104 x 27»	3,8-5,1 X 27-32	7824.5371.0	10B «57x27»	Pg13,5x2	7810.6612.5				32B «77 x 62»	Pg 36	7832.6540.0
24B «104 x 27»	3,8-5,1 X 42-46	7824.5372.0	16B «77x27»	M 20x2	7816.6618.5				32B «77 x 62»	Pg 42	7832.6541.0
24B «104 x 27»	3,8-5,1 X 48-53	7824.5373.0	16B «77x27»	M 25x2	7816.6619.5				10B «57 x 27»	M 25	7810.7003.5
24B «104 x 27»	3,8-5,1 X 62-66	7824.5374.0	16B «77x27»	M 16x2	7816.6621.5				10B «57 x 27»	M 32	7810.7004.5
24B «104 x 27»	4,5-5,7 X 72-76	7824.5375.0	16B «77x27»	Pg16x2	7816.6622.5				10B «57 x 27»	Pg 21	7810.7104.5
			16B «77x27»	Pg 21x2	7816.6622.5				10B «57 x 27»	Pg 29	7810.7105.5
			24B «104x27»	M 32x2	7824.6625.5				16B «77 x 27»	M 25	7816.6457.5
			24B «104x27»	M 40x2	7824.6626.5				16B «77 x 27»	M 32	7816.6458.5
			24B «104x27»	Pg21x2	7824.6627.5				16B «77 x 27»	Pg 21	7816.6435.5
			24B «104x27»	Pg 29x2	7824.6628.5				16B «77 x 27»	Pg 29	7816.6436.5
									24B «104 x 27»	M 25	7824.6459.5
									24B «104 x 27»	M 32	7824.6460.5
									24B «104 x 27»	Pg 21	7824.6437.5
									24B «104 x 27»	Pg 29	7824.6438.5
									32B «77 x 62»	M 32	7832.6589.5
									32B «77 x 62»	M 40	7832.6590.5
									32B «77 x 62»	M 50	7832.6591.5
									32B «77 x 62»	Pg 29	7832.6539.5
									32B «77 x 62»	Pg 36	7832.6540.5
									32B «77 x 62»	Pg 42	7832.6541.5

Type: STD for inserts up to 500V S-D, S-DD, S-E, S-ES, S-ESHV, S-EE, S-HSB, S-K, S-M series



For more technical details and STD-HV, HE, HE-HV, EMC types, please consult the Westec General Catalogue

Accessories, cable glands and tools see page: 42 + 51

Hoods top entry with 2 levers and gasket			Covers with 4 pegs Covers with 2 levers			Surface mounting housings, reversed locking			Surface mounting housings with cover, reversed locking		
											
Size	Thread	Part No.	Size	Thread	Part No.	Size	Thread	Part No.	Size	Thread	Part No.
10B «57 x 27»	M 20	7810.6598.0	10B «57 x 27»	With 4 pegs	7810.6805.0	10B «57 x 27»	M 20	7810.5001.0	10B «57 x 27»	M 20	7810.5023.0
10B «57 x 27»	M 25	7810.6586.0	16B «77 x 27»		7816.6806.0	10B «57 x 27»	M 20X2	7810.5002.0	10B «57 x 27»	M 20X2	7810.5024.0
10B «57 x 27»	Pg 16	7810.6536.0	24B «104 x 27»		7824.6807.0	10B «57 x 27»	Pg 16	7810.5003.0	10B «57 x 27»	Pg 16	7810.5025.0
			32B «77 x 62»		7832.6808.0	10B «57 x 27»	Pg 16X2	7810.5004.0	10B «57 x 27»	Pg 16X2	7810.5026.0
16B «77 x 27»	M 25	7816.6587.0	10B «57 x 27»	With 2 levers and gasket	7810.6809.0	16B «77 x 27»	M 25	7816.5005.0	16B «77 x 27»	M 25	7816.5027.0
16B «77 x 27»	M 32	7816.6923.0	16B «77 x 27»		7816.6810.0	16B «77 x 27»	M 25X2	7816.5006.0	16B «77 x 27»	M 25X2	7816.5028.0
16B «77 x 27»	Pg 21	7816.6537.0	24B «104 x 27»		7824.6811.0	16B «77 x 27»	Pg 21	7816.5007.0	16B «77 x 27»	Pg 21	7816.5029.0
			32B «77 x 62»		7832.6812.0	16B «77 x 27»	Pg 21X2	7816.5008.0	16B «77 x 27»	Pg 21X2	7816.5030.0
24B «104 x 27»	M 32	7824.6588.0				24B «104 x 27»	M 25	7824.5009.0	24B «104 x 27»	M 25	7824.5031.0
24B «104 x 27»	Pg 21	7824.6538.0				24B «104 x 27»	M 25X2	7824.5010.0	24B «104 x 27»	M 25X2	7824.5032.0
24B «104 x 27»	Pg 29	7824.7146.0				24B «104 x 27»	Pg 21	7824.5011.0	24B «104 x 27»	Pg 21	7824.5033.0
						24B «104 x 27»	Pg 21X2	7824.5012.0	24B «104 x 27»	Pg 21X2	7824.5034.0
						32B «77 x 62»	M 40	7832.5013.0	32B «77 x 62»	M 40	7832.5035.0
						32B «77 x 62»	M 40X2	7832.5014.0	32B «77 x 62»	M 40X2	7832.5036.0
						32B «77 x 62»	M 50	7832.5015.0	32B «77 x 62»	M 50	7832.5037.0
						32B «77 x 62»	M 50X2	7832.5016.0	32B «77 x 62»	M 50X2	7832.5038.0
						32B «77 x 62»	Pg 29	7832.5017.0	32B «77 x 62»	Pg 29	7832.5039.0
						32B «77 x 62»	Pg 29X2	7832.5018.0	32B «77 x 62»	Pg 29X2	7832.5040.0
						32B «77 x 62»	Pg 36	7832.5019.0	32B «77 x 62»	Pg 36	7832.5041.0
						32B «77 x 62»	Pg 36X2	7832.5020.0	32B «77 x 62»	Pg 36X2	7832.5042.0
						32B «77 x 62»	Pg 42◇	7832.5021.0	32B «77 x 62»	Pg 42 ◇	7832.5043.0
						32B «77 x 62»	Pg 42X2◇	7832.5022.0	32B «77 x 62»	Pg 42X2 ◇	7832.5044.0
Type: STD for inserts up to 500V S-D, S-DD, S-E, S-ES, S-ESHV, S-EE, S-HSB, S-K, S-M series			 			For more technical details and STD-HV, HE, HE-HV, EMC types, please consult the Westec General Catalogue			Accessories, cable glands and tools see page: 42 ÷ 51		

Surface mounting housings			Surface mounting housings with cover			Bulkhead mounting housings			Hoods top entry with 2 levers without gasket		
 <p>HC - High construction</p>			 <p>HC - High construction</p>			 <p>With cover</p>					
Size	Typo	Part No.	Size	Thread	Part No.	Size		Part No.	Size	Thread	Part No.
10B «57 x 27»	M 25X2	7810.5129.0	10B «57 x 27»	M 25X2	7810.5159.0	10B «57 x 27» 16B «77 x 27» 24B «104 x 27» 32B «77 x 62»		Without cover	10B «57 x 27»	M 20	7810.5060.0
10B «57 x 27»	M 32	7810.5130.0	10B «57 x 27»	M 32	7810.5160.0			7810.5050.0	10B «57 x 27»	M 25	7810.5061.0
10B «57 x 27»	M 32X2	7810.5131.0	10B «57 x 27»	M 32X2	7810.5161.0			7816.5051.0	10B «57 x 27»	Pg 16	7810.5062.0
10B «57 x 27»	M 40	7810.5132.0	10B «57 x 27»	M 40	7810.5162.0			7824.5052.0	16B «77 x 27»	M 25	7816.5063.0
10B «57 x 27»	M 40X2	7810.5133.0	10B «57 x 27»	M 40X2	7810.5163.0			7832.5053.0	16B «77 x 27»	M 32	7816.5064.0
10B «57 x 27»	Pg 21	7810.5134.0	10B «57 x 27»	Pg 21	7810.5164.0			With cover	16B «77 x 27»	Pg 21	7816.5065.0
10B «57 x 27»	Pg 21X2	7810.5135.0	10B «57 x 27»	Pg 21X2	7810.5165.0			10B «57 x 27»	24B «104 x 27»	M 25	7824.5066.0
10B «57 x 27»	Pg 29	7810.5136.0	10B «57 x 27»	Pg 29	7810.5166.0			16B «77 x 27»	24B «104 x 27»	M 32	7824.5067.0
10B «57 x 27»	Pg 29X2	7810.5137.0	10B «57 x 27»	Pg 29X2	7810.5167.0			16B «77 x 27»	24B «104 x 27»	Pg 21	7824.5068.0
16B «77 x 27»	M 32	7816.5138.0	16B «77 x 27»	M 32	7816.5169.0			24B «104 x 27»	24B «104 x 27»	Pg 29	7824.5069.0
16B «77 x 27»	M 32X2	7816.5139.0	16B «77 x 27»	M 32X2	7816.5170.0	32B «77 x 62»					
16B «77 x 27»	M 40	7816.5140.0	16B «77 x 27»	M 40	7816.5171.0						
16B «77 x 27»	M 40X2	7816.5141.0	16B «77 x 27»	M 40X2	7816.5172.0						
16B «77 x 27»	Pg 21	7816.5142.0	16B «77 x 27»	Pg 21	7816.5173.0						
16B «77 x 27»	Pg 21X2	7816.5143.0	16B «77 x 27»	Pg 21X2	7816.5174.0						
16B «77 x 27»	Pg 29	7816.5144.0	16B «77 x 27»	Pg 29	7816.5175.0						
16B «77 x 27»	Pg 29X2	7816.5145.0	16B «77 x 27»	Pg 29X2	7816.5176.0						
24B «104 x 27»	M 32	7824.5147.0	24B «104 x 27»	M 32	7824.5178.0						
24B «104 x 27»	M 32X2	7824.5148.0	24B «104 x 27»	M 32X2	7824.5179.0						
24B «104 x 27»	M 40	7824.5149.0	24B «104 x 27»	M 40	7824.5180.0						
24B «104 x 27»	M 40X2	7824.5150.0	24B «104 x 27»	M 40X2	7824.5181.0						
24B «104 x 27»	Pg 21	7824.5151.0	24B «104 x 27»	Pg 21	7824.5182.0						
24B «104 x 27»	Pg 21X2	7824.5152.0	24B «104 x 27»	Pg 21X2	7824.5183.0						
24B «104 x 27»	Pg 29	7824.5153.0	24B «104 x 27»	Pg 29	7824.5184.0						
24B «104 x 27»	Pg 29X2	7824.5154.0	24B «104 x 27»	Pg 29X2	7824.5185.0						
Type: STD for inserts up to 500V S-D, S-DD, S-E, S-ES, S-ESHV, S-EE, S-HSB, S-K, S-M series						For more technical details and STD-HV, HE, HE-HV, EMC types, please consult the Westec General Catalogue			Accessories, cable glands and tools see page: 42 ÷ 51		

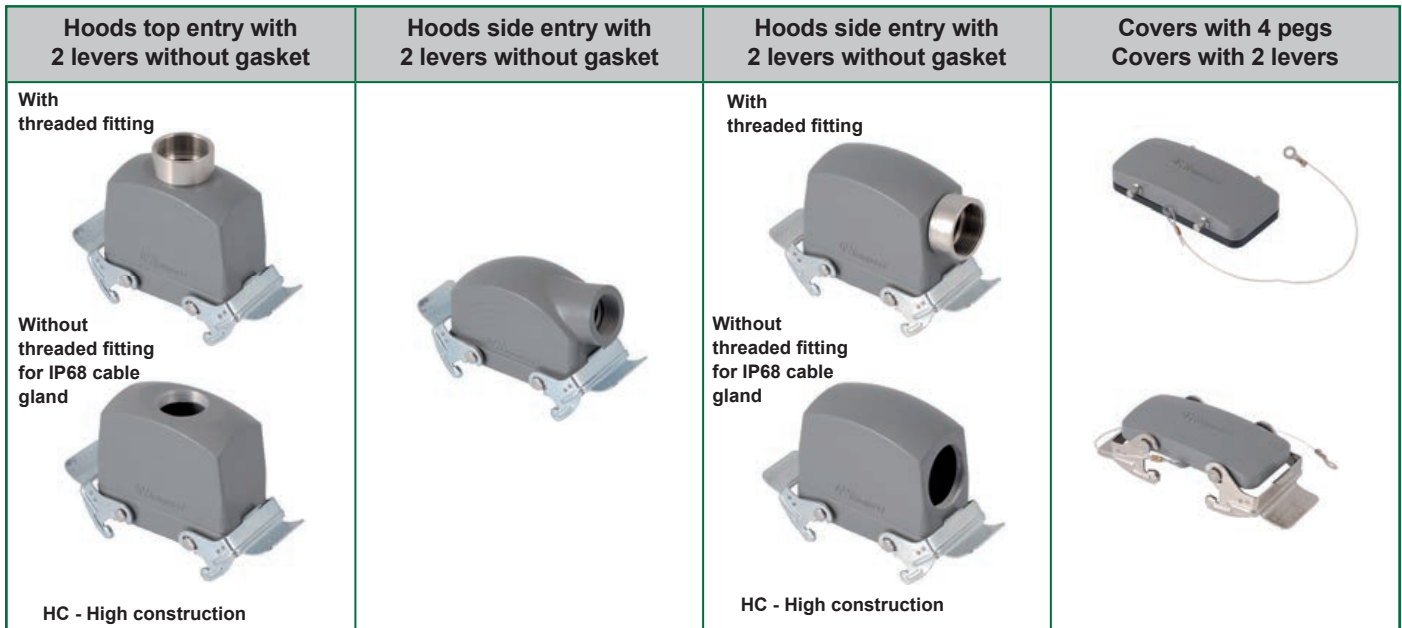

Size	Thread	Part No.	Size	Thread	Part No.	Size	Thread	Part No.	Size	Part No.
		With threaded fitting	10B «57 x 27»	M 20	7810.5090.0			With threaded fitting		With 4 pegs and gasket
10B «57 x 27»	M 32	7810.5070.0	10B «57 x 27»	M 25	7810.5091.0	10B «57 x 27»	M 32	7810.5100.0		7810.5120.0
10B «57 x 27»	M 40	7810.5071.0	10B «57 x 27»	Pg 16	7810.5092.0	10B «57 x 27»	M 40	7810.5101.0		7816.5121.0
10B «57 x 27»	Pg 21	7810.5072.0	16B «77 x 27»	M 25	7816.5093.0	10B «57 x 27»	Pg 21	7810.5102.0	10B «57 x 27»	7824.5122.0
10B «57 x 27»	Pg 29	7810.5073.0	16B «77 x 27»	M 32	7816.5094.0	10B «57 x 27»	Pg 29	7810.5103.0	16B «77 x 27»	7832.5123.0
16B «77 x 27»	M 32	7816.5074.0	16B «77 x 27»	M 32	7816.5095.0	16B «77 x 27»	M 32	7816.5104.0	24B «104 x 27»	
16B «77 x 27»	M 40	7816.5075.0	16B «77 x 27»	Pg 21	7816.5096.0	16B «77 x 27»	M 40	7816.5105.0	32B «77 x 62»	
16B «77 x 27»	Pg 21	7816.5076.0	24B «104 x 27»	M 25	7824.5096.0	16B «77 x 27»	Pg 21	7816.5106.0		With 2 levers without gasket
16B «77 x 27»	Pg 29	7816.5077.0	24B «104 x 27»	M 32	7824.5097.0	24B «104 x 27»	Pg 29	7816.5107.0	10B «57 x 27»	7810.5124.0
24B «104 x 27»	M 32	7824.5078.0	24B «104 x 27»	M 32	7824.5098.0	24B «104 x 27»	M 32	7824.5108.0	16B «77 x 27»	7816.5125.0
24B «104 x 27»	M 40	7824.5079.0	24B «104 x 27»	Pg 21	7824.5099.0	24B «104 x 27»	M 40	7824.5109.0	24B «104 x 27»	7824.5126.0
24B «104 x 27»	Pg 21	7824.5080.0		Pg 29		24B «104 x 27»	Pg 21	7824.5110.0	32B «77 x 62»	7832.5127.0
24B «104 x 27»	Pg 29	7824.5081.0				24B «104 x 27»	Pg 29	7824.5111.0		
32B «77 x 62»	M 32	7832.5082.0				32B «77 x 62»	M 32	7832.5112.0		
32B «77 x 62»	M 40	7832.5083.0				32B «77 x 62»	M 40	7832.5113.0		
32B «77 x 62»	Pg 29	7832.5085.0				32B «77 x 62»	Pg 21	7832.5114.0		
32B «77 x 62»	Pg 36	7832.5086.0				32B «77 x 62»	Pg 29	7832.5115.0		
		Without threaded fitting						Without threaded fitting		
10B «57 x 27»	M 32	7810.5070.5				10B «57 x 27»	M 32	7810.5100.5		
10B «57 x 27»	M 40	7810.5071.5				10B «57 x 27»	M 40	7810.5101.5		
10B «57 x 27»	Pg 21	7810.5072.5				10B «57 x 27»	Pg 21	7810.5102.5		
10B «57 x 27»	Pg 29	7810.5073.5				10B «57 x 27»	Pg 29	7810.5103.5		
16B «77 x 27»	M 32	7816.5074.5				16B «77 x 27»	M 32	7816.5104.5		
16B «77 x 27»	M 40	7816.5075.5				16B «77 x 27»	M 40	7816.5105.5		
16B «77 x 27»	Pg 21	7816.5076.5				16B «77 x 27»	Pg 21	7816.5106.5		
16B «77 x 27»	Pg 29	7816.5077.5				16B «77 x 27»	Pg 29	7816.5107.5		
24B «104 x 27»	M 32	7824.5078.5				24B «104 x 27»	M 32	7824.5108.5		
24B «104 x 27»	M 40	7824.5079.5				24B «104 x 27»	M 40	7824.5109.5		
24B «104 x 27»	Pg 21	7824.5080.5				24B «104 x 27»	Pg 21	7824.5110.5		
24B «104 x 27»	Pg 29	7824.5081.5				24B «104 x 27»	Pg 29	7824.5111.5		
32B «77 x 62»	M 32	7832.5082.5				32B «77 x 62»	M 32	7832.5112.5		
32B «77 x 62»	M 40	7832.5083.5				32B «77 x 62»	M 40	7832.5113.5		
32B «77 x 62»	Pg 29	7832.5085.5				32B «77 x 62»	Pg 21	7832.5114.5		
32B «77 x 62»	Pg 36	7832.5086.5				32B «77 x 62»	Pg 29	7832.5115.5		
						32B «77 x 62»	Pg 36	7832.5116.5		

Type: STD for inserts up to 500V S-D, S-DD, S-E, S-ES, S-ESHV, S-EE, S-HSB, S-K, S-M series



For more technical details and STD-HV, HE, HE-HV, EMC types, please consult the Westec General Catalogue

Accessories, cable glands and tools see page: 42 + 51

Technical characteristics

cULus, Type 4/4x/12



- ▣ Housing with cover with single or double locking system

Technical characteristics:

- **Type:** - STD for standard industrial applications
- HE for harsh environmental requirements
- EMC for EMC applications
- **Size:** 32A «66x40»
- **Material:** Body and cover: aluminium alloy
Painting: polyester powder coating
EMC finishing: Aluminium natural color
Locking device: stainless steel
- **Operating temperature** -25°C ÷ 125°C
- **Protection degree** IP66

For more details please consult the Westec General Catalogue

- ▣ Power sockets for European and International market
- ▣ Standard interfaces for easy connection of devices within and outside of control cabinet
- ▣ Suitable for:
 - Standard industrial applications (STD)
 - For Harsh environmental requirements (HE)
 - For applications that require electromagnetic compatibility (EMC)
- ▣ Horizontal and vertical mounting
- ▣ Modular assembly, suitable for different adaptors plates
- ▣ Lockable metal cover by levers
- ▣ IP66 protection degree (with closed cover)
- ▣ High resistance to mechanical impacts
- ▣ High resistance to high and low temperature
- ▣ EMC shielding with EMC housings
- ▣ Compact design
- ▣ Termination technology of data connectors

The system is based on a wide range of data connectors that can be connected into both sides (gender changers) without any soldering or crimping.
- ▣ Modular system

The system is based on a bulkhead housing with a cover to be assembled on the panel. This housing is flexible enough to host a series of modules with different power sockets or data interfaces in accordance with the relevant standards. This allows the ports to satisfy customer demand.

Blank panels permit other interfaces to be assembled on customer demand.
- ▣ Assembled cables

A wide range of assembled cables which connect the interfaces to the equipment are also available.

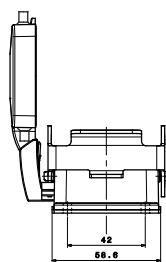
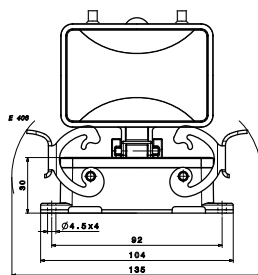
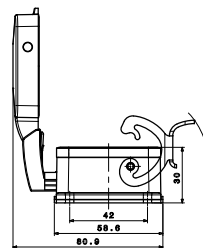
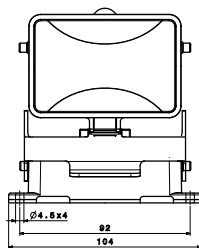

Color	Type	Part No.
Grey RAL 7037	STD	With one lever 7832.4700.0
Grey RAL 7035	STD	7832.4710.0
Black RAL 9005	HE	7832.4700.1
Black RAL 9005	EMC	7832.4700.4
Grey RAL 7037	STD	With 2 levers 7832.4705.0
Grey RAL 7035	STD	7832.4715.0
Black RAL 9005	HE	7832.4705.1
Black RAL 9005	EMC	7832.4705.4

Power interfaces (Sockets)			High performance cables	Description	L. m.	Part. No.
Germany (VDE) 2p+ ⊕  Part. No.: 2000.3001.0	USA/Japan 2p+ ⊕ x2  Part.No.: 2000.3002.0	Italy 2p+ ⊕ x 2  Part.No.: 2000.3003.0		D - Sub 9 - D - Sub 9 M - M Serial cable, male to male, fully connected, pin to pin, black color UL2464 RoHS	2	2000.3100.0
					Serial cable, male to male, fully connected, pin to pin, black color UL2464 RoHS	5
France 2p+ ⊕  Part.No.: 2000.3004.0	UK 2p+ ⊕  Part.No.: 2000.3005.0	Australia/China 2p+ ⊕ Argentina  Part.No.: 2000.3006.0		D - Sub 9 - D - Sub 9 M - F Serial cable, male to female, fully connected, pin to pin, black color UL2464 RoHS	2	2000.3110.0
					Serial cable, male to female, fully connected, pin to pin, black color UL2464 RoHS	5
Swiss 2p+ ⊕ x2  Part.No.: 2000.3007.0	Euro/USA 2p+ ⊕ x2  Part.No.: 2000.3008.0	Germany - Italy 2p+ ⊕  Part. No.: 2000.3013.0		D - Sub 25 - D - Sub 25 F - F Serial cable, female to female, fully connected, pin to pin, black color UL2464 RoHS	2	2000.3120.0
					Serial cable, female to female, fully connected, pin to pin, black color UL2464 RoHS	5
				D - Sub 25 - D - Sub 25 M - F Serial cable, male to female, fully connected, pin to pin, black color UL2464 RoHS	2	2000.3140.0
					Serial cable, male to female, fully connected, pin to pin, black color UL2464 RoHS	5
Data interfaces						
D-Sub 9 F-F  Part. No.: 2000.3020.0	D-Sub 25 F-M  Part. No.: 2000.3021.0	D-Sub 9 F-M x2  Part. No.: 2000.3022.0		RJ45 8p M - M CAT5e UTP RJ45 8p male to RJ45 8p male UTP stranded cable, grey color RoHS	0,5	2100.3150.0
					RJ45 8p male to RJ45 8p male UTP stranded cable, grey color RoHS	2
					3	2100.3150.3
					RJ45 8p male to RJ45 8p male FTP stranded cable, grey color RoHS	5
					2	2100.3401.2
					RJ45 8p male to RJ45 8p male FTP stranded cable, grey color RoHS	3
					5	2100.3401.5
					USB V.2 480 M bps M - M USB A male to USB A male cable, black color RoHS	0,5
					2	2000.3170.0
					USB A male to USB A male cable, black color RoHS	5
					0,5	2000.3180.A
					USB A male to USB B male cable, black color RoHS	2
FF RJ45 / USB / D-Sub 25 M-F  Part. No.: 2000.3033.0	RJ45 - D-Sub 9/25 F-M  Part. No.: 2000.3035.0	Blanck plate  Part. No.: 2000.3036.0				

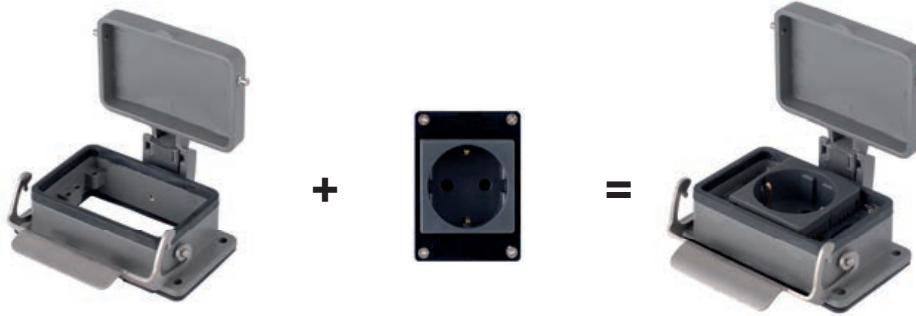

CE (RoHS)

UL US, Type 4/4x/12
For the housing

Housing Part. No	Interface Part. No	Description	Set Part. No
7832.4700.0	2000.3001.0	Power interface GERMANY (VDE) 2p+ ⊕	7932.3001.0
7832.4700.0	2000.3002.0	Power interface USA / JAPAN 2p+ ⊕ x 2	7932.3002.0
7832.4700.0	2000.3003.0	Power interface ITALY 2p+ ⊕ x 2	7932.3003.0
7832.4700.0	2000.3004.0	Power interface FRANCE 2p+ ⊕	7932.3004.0
7832.4700.0	2000.3005.0	Power interface GREAT BRITAIN 2p+ ⊕	7932.3005.0
7832.4700.0	2000.3006.0	Power interface AUSTRALIA / CHINA / Argentina 2p+ ⊕	7932.3006.0
7832.4700.0	2000.3007.0	Power interface SWITZERLAND 2p+ ⊕ x 2	7932.3007.0
7832.4700.0	2000.3008.0	Power interface EURO / USA 2p+ ⊕ x 2	7932.3008.0
7832.4700.0	2000.3013.0	Power interface GERMANY + ITALY 10/16A 2p+ ⊕	7932.3013.0
7832.4700.0	2000.3020.0	Data interface D-SUB 9 F-F	7932.3020.0
7832.4700.0	2000.3021.0	Data interface D-SUB 25 F-M	7932.3021.0
7832.4700.0	2000.3022.0	Data interface D-SUB 9 F-M X 2	7932.3022.0
7832.4700.0	2000.3023.0	Data interface D-SUB 25 F-M X 2	7932.3023.0
7832.4700.0	2000.3024.0	Data interface D-SUB 25 F-M + D-SUB 9 F-M	7932.3024.0
7832.4700.0	2000.3025.0	Data interface USB A 2.0 F-F X 2	7932.3025.0
7832.4700.0	2000.3027.0	Data interface RJ45 shielded F-F X 2	7932.3027.0
7832.4700.0	2000.3029.0	Data interface RJ45 F-F, D-SUB 9 F-F, D-SUB 9 M-M	7932.3029.0
7832.4700.0	2000.3031.0	Data interface RJ45 F-F, D-SUB 9 F-M, USB A 2.0 F-F	7932.3031.0
7832.4700.0	2000.3033.0	Data interface RJ45 F-F, D-SUB 25 F-M, USB A 2.0 F-F	7932.3033.0
7832.4700.0	2000.3035.0	Data interface RJ45 F-F, D-SUB 25 F-M, D-SUB 9 F-M	7932.3035.0

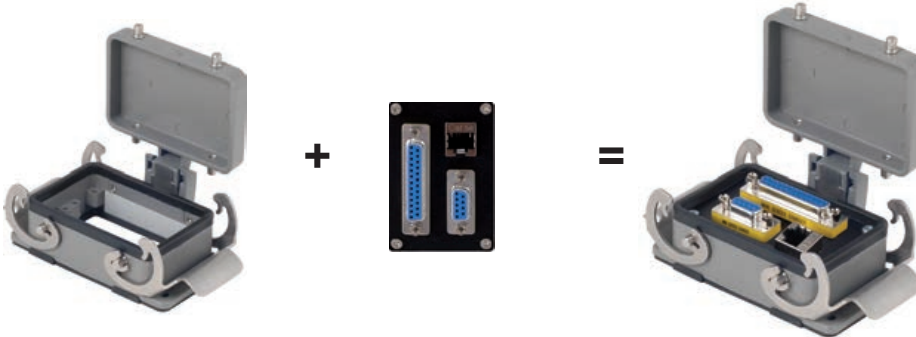









CE (RoHS)

UL US, Type 4/4x/12
For the housing

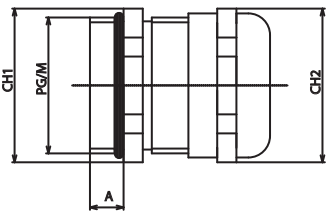
Housing Part. No	Interface Part. No	Description	Set Part. No
7832.4705.0	2000.3001.0	Power interface GERMANY (VDE) 2p+ ⊕	7932.4001.0
7832.4705.0	2000.3002.0	Power interface USA / JAPAN 2p+ ⊕ x 2	7932.4002.0
7832.4705.0	2000.3003.0	Power interface ITALY 2p+ ⊕ x 2	7932.4003.0
7832.4705.0	2000.3004.0	Power interface FRANCE 2p+ ⊕	7932.4004.0
7832.4705.0	2000.3005.0	Power interface GREAT BRITAIN 2p+ ⊕	7932.4005.0
7832.4705.0	2000.3006.0	Power interface AUSTRALIA / CHINA / Argentina 2p+ ⊕	7932.4006.0
7832.4705.0	2000.3007.0	Power interface SWITZERLAND 2p+ ⊕ x 2	7932.4007.0
7832.4705.0	2000.3008.0	Power interface EURO / USA 2p+ ⊕ x 2	7932.4008.0
7832.4705.0	2000.3013.0	Power interface GERMANY + ITALY 10/16A 2p+ ⊕	7932.4013.0
7832.4705.0	2000.3020.0	Data interface D-SUB 9 F-F	7932.4020.0
7832.4705.0	2000.3021.0	Data interface D-SUB 25 F-M	7932.4021.0
7832.4705.0	2000.3022.0	Data interface D-SUB 9 F-M X 2	7932.4022.0
7832.4705.0	2000.3023.0	Data interface D-SUB 25 F-M X 2	7932.4023.0
7832.4705.0	2000.3024.0	Data interface D-SUB 25 F-M + D-SUB 9 F-M	7932.4024.0
7832.4705.0	2000.3025.0	Data interface USB A 2.0 F-F X 2	7932.4025.0
7832.4705.0	2000.3027.0	Data interface RJ45 shielded F-F X 2	7932.4027.0
7832.4705.0	2000.3029.0	Data interface RJ45 F-F, D-SUB 9 F-F, D-SUB 9 M-M	7932.4029.0
7832.4705.0	2000.3031.0	Data interface RJ45 F-F, D-SUB 9 F-M, USB A 2.0 F-F	7932.4031.0
7832.4705.0	2000.3033.0	Data interface RJ45 F-F, D-SUB 25 F-M, USB A 2.0 F-F	7932.4033.0
7832.4705.0	2000.3035.0	Data interface RJ45 F-F, D-SUB 25 F-M, D-SUB 9 F-M	7932.4035.0

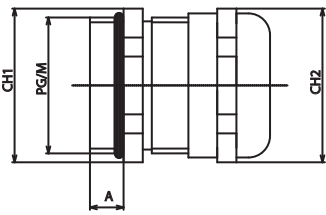
Cables	Description	Category	L. mm.	Part. No.	Connectors Cat5e IP66/IP67	Type	Part. No.	
	U/UTP 4 twisted pairs AWG24/ AWG23 solid wires, installation cable PVC - LSOH Grey	Cat 5e (AWG24)	305	2110.3210.0	 Insulating hoods and cable glands - Black	Male STD with Pg11 Cable gland	2100.3310.1	
		Cat 6 (AWG23)	305	2110.3220.0		Without cable gland	2100.3310.6	
	U/UTP 4 twisted pairs AWG24 stranded wires, connecting cable PVC - Grey	Cat 5e	305	2100.3212.0	 Metal hoods and cable glands	Male STD with Pg11 Cable gland	2100.3320.0	
		Cat 6	305	2110.3222.0		Without cable gland	2100.3320.5	
	F/UTP shielded cable, 4 twisted pairs AWG24 solid wires, installation cable PVC - LSOH Grey	Cat 5e (AWG24)	305	2110.3214.0	 Insulating hoods and cable glands - Black	Male STD with Pg11 Cable gland	2100.3312.1	
		Cat 6 (AWG23)	305	2110.3224.0		Without cable gland	2100.3312.6	
	F/UTP shielded cable, 4 twisted pairs AWG24 stranded wires, connecting cable PVC - Grey	Cat 5e	305	2110.3216.0	 Metal hoods and cable glands	Male STD with Pg11 Cable gland	2100.3322.0	
		Cat 6	305	2110.3226.0		Without cable gland	2100.3322.5	
RJ45 male 8p 8c connectors for solid and stranded wires AWG 22/26			Type	Part.No	 Insulating housing - Black	STD	2100.3316.1	
	For UTP	CAT 5e 8p 8c	2100.3280.0					
		For F/UTP	8p 8c	2100.3284.0				
	For UTP	CAT 6 8p 8c	2100.3290.0					
		For F/UTP	8p 8c	2100.3294.0				
	Strain relief grey	Dia 5,5	2100.3285.0					
		Dia 6,5	2100.3286.0					
Patch cords			Cat.	Type	L. mm.	Part.No	Part. No	
RJ45 8p - 8c male to male, U-UTP cable, stranded wire AWG 24 PVC grey	Cat 5e	U/ UTP	0,5	2100.3150.0	 Patch cords with strain relief and cap Lunghezza RJ45 CAT6	0,5 m.		FTP
			1	2100.3150.1		1 m.	FTP	2100.3502.1
			2	2100.3150.2		2 m.	FTP	2100.3502.2
			3	2100.3150.3		3 m.	FTP	2100.3502.3
			5	2100.3150.5		5 m.	FTP	2100.3502.5
			10	2100.3150.A				
RJ45 8p - 8c male to male, F-UTP shielded cable, stranded wire AWG 24 PVC grey	Cat 5e	F/ UTP	0,5	2100.3401.0	 Female connector panel mounting			
			1	2100.3401.1				
			2	2100.3401.2				
			3	2100.3401.3				
			5	2100.3401.5				
			10	2100.3401.A				
RJ45 8p - 8c male to male, U-UTP cable, stranded wire AWG 24 PVC grey	Cat 6	U/ UTP	0,5	2100.3155.0	 Female connector panel mounting			
			1	2100.3155.1				
			2	2100.3155.2				
			3	2100.3155.3				
			5	2100.3155.5				
			10	2100.3155.A				
RJ45 8p - 8c male to male, F-UTP shielded cable, stranded wire AWG 24 PVC grey	Cat 6	F/ UTP	0,5	2100.3406.0	 Female connector panel mounting			
			1	2100.3406.1				
			2	2100.3406.2				
			3	2100.3406.3				
			5	2100.3406.5				
			10	2100.3406.A				

IP66 cable glands for MIC hoods (1,2)			IP65 cable glands with cylindrical body (2,3)			IP68 metal cable glands- 5 bar (2,4)			IP68 metal cable glands (2,4)		
<p>Metal type</p>  <p>Polyamide type</p> 			<p>With gasket</p>  <p>With hexagonal part</p> 			 			 		
Cable Dia mm.	Thread	Part No.	Cable Dia mm.	Thread	Part No.	Cable Dia A	Thread	Part No.	Cable Dia A	Thread	Part No.
		Metal type	5 - 7	M 12x1,5	7000.7710.0	4 - 10/6	M 16x1,5	7000.6896.0	3 - 6/6	M 12x1,5	7000.6899.3
3.5 - 12.5	M 20x1,5	7000.6848.0	4 - 9.5	M 16x1,5	7000.7711.0	8 - 14/6,5	M 20x1,5	7000.6831.0	5 - 9/6	M 16x1,5	7000.6896.3
8 - 17	M 25x1,5	7000.6849.0	6 - 13	M 20x1,5	7000.7712.0	11 - 18/7	M 25x1,5	7000.6832.0	9 - 13/8	M 20x1,5	7000.6831.3
15.5 - 24.5	M 32x1,5	7000.6850.0	6 - 15	M 25x1,5	7000.7713.0	14 - 21/8	M 32x1,5	7000.6833.0	11 - 16/8	M 25x1,5	7000.6832.3
22.5 - 31.5	M 40x1,5	7000.6851.0	9 - 20	M 32x1,5	7000.7714.0	19 - 28/9	M 40x1,5	7000.6834.0	14 - 21/8	M 32x1,5	7000.6833.3
29.5 - 38.5	M 50x1,5	7000.6852.0	15 - 27	M 40x1,5	7000.7715.0	24 - 38/9	M 50x1,5	7000.3535.0	19 - 27/9	M 40x1,5	7000.6834.3
7 - 12	Pg 11	7000.6841.0	21 - 33	M 50x1,5	7000.7716.0	4 - 10/6	Pg 11	7000.6825.0	24 - 35/9	M 50x1,5	7000.6835.3
7 - 12	Pg 13.5	7000.6842.0	30 - 45	M 63x1,5	7000.7717.0	5 - 12/6,5	Pg 13.5	7000.6826.0	38 - 48/12	M 63x1,5	7000.6836.3
7 - 14.5	Pg 16	7000.6843.0	4 - 9.5	Pg 9	7000.7701.0	8 - 14/6,5	Pg 16	7000.6827.0	3 - 6,5/6	Pg 7	7000.6900.3
9.5 - 18.5	Pg 21	7000.6844.0	4 - 11	Pg 11	7000.7702.0	11 - 18/7	Pg 21	7000.6828.0	4 - 8/6	Pg 9	7000.6901.3
17.5 - 26.5	Pg 29	7000.6845.0	6 - 13	Pg 13.5	7000.7703.0	16 - 25/8	Pg 29	7000.6829.0	6 - 10/6	Pg 11	7000.6825.3
23.5 - 32.5	Pg 36	7000.6846.0	6 - 15	Pg 16	7000.7704.0	19 - 36/9	Pg 36	7000.6830.0	6 - 12/8	Pg 13.5	7000.6826.3
29.5 - 38.5	Pg 42	7000.6847.0	9 - 20	Pg 21	7000.7705.0	30 - 38/9	Pg 42	7000.6897.0	10 - 13/6,5	Pg 16	7000.6827.3
		Insulating type	15 - 27	Pg 29	7000.7706.0				14 - 18/7,5	Pg 21	7000.6828.3
3.5 - 12.5	M 20x1,5	7000.6839.0	21 - 33	Pg 36	7000.7707.0				20 - 25/8	Pg 29	7000.6829.3
7 - 12	Pg 11	7000.6837.0	27 - 40	Pg 42	7000.7708.0				22 - 32/8	Pg 36	7000.6830.3
		Black color	30 - 45	Pg 48	7000.7709.0				32 - 38/12	Pg 42	7000.6897.3
3.5 - 12.5	M 20 x1,5	7000.6839.1			With hexagonal part				37 - 44/12	Pg 48	7000.6898.3
7 - 12	Pg 11	7000.6837.1	5 - 7	M 12x1,5	7000.7730.0						
			4 - 9.5	M 16x1,5	7000.7731.0						
			6 - 13	M 20x1,5	7000.7732.0						
			6 - 15	M 25x1,5	7000.7733.0						
			9 - 20	M 32x1,5	7000.7734.0						
			15 - 27	M 40x1,5	7000.7735.0						
			21 - 33	M 50x1,5	7000.7736.0						
			30 - 45	M 63x1,5	7000.7737.0						
			4 - 9.5	Pg 9	7000.7721.0						
			4 - 11	Pg 11	7000.7722.0						
			6 - 13	Pg 13.5	7000.7723.0						
			6 - 15	Pg 16	7000.7724.0						
			9 - 20	Pg 21	7000.7725.0						
			15 - 27	Pg 29	7000.7726.0						
			21 - 33	Pg 36	7000.7727.0						
			27 - 40	Pg 42	7000.7728.0						
			30 - 45	Pg 48	7000.7729.0						
<p>1 - For industrial connectors hoods/housings</p>			<p> 2 - For more details please consult the Westec General Catalogue</p>			<p>3 - For any sealed enclosures and boxes to protect parts, mechanisms and equipments from atmospheric agents</p>			<p>4 - For industrial connectors hoods/housings where higher protection and pulling strength are required. For sealed enclosures and boxes</p>		

Technical characteristics	L	Spanner		Panel drilling	Cable Dia	Thread	Part No.	Part No.	Part No.
		SW1	SW2						
	11	16	16	12.5	3 - 6,5	M 12x1,5	7000.7821.1	7000.7821.2	7000.7821.0
	11	19	19	16.5	4 - 8	M 16x1,5	7000.7822.1	7000.7822.2	7000.7822.0
	10,2	24	24	20.5	7 - 12	M 20x1,5	7000.7823.1	7000.7823.2	7000.7823.0
	12	32	32	25.5	11 - 18	M 25x1,5	7000.7824.1	7000.7824.2	7000.7824.0
	14	35	35	32.5	12 - 21	M 32x1,5	7000.7825.1	7000.7825.2	7000.7825.0
	15	53	53	40.5	22 - 32	M 40x1,5	7000.7826.1	7000.7826.2	7000.7826.0
	16,5	60	60	50.5	30 - 38	M 50x1,5	7000.7827.1	7000.7827.2	7000.7827.0
	20	68	68	63.5	35 - 44	M 63x1,5	7000.7828.1	7000.7828.2	7000.7828.0
	11	16	16	12.7	3 - 6,5	Pg 7	7000.7829.1	7000.7829.2	7000.7829.0
	10,2	19	19	15.4	4 - 8	Pg 9	7000.7830.1	7000.7830.2	7000.7830.0
	10,2	22	22	18,8	5 - 10	Pg 11	7000.7831.1	7000.7831.2	7000.7831.0
	12	24	24	20,7	6 - 11	Pg 13.5	7000.7832.1	7000.7832.2	7000.7832.0
	12	27	27	22,8	9 - 13	Pg 16	7000.7833.1	7000.7833.2	7000.7833.0
	12	33	33	28,6	13 - 18	Pg 21	7000.7834.1	7000.7834.2	7000.7834.0
	14,5	42	42	37,4	17,5 - 25	Pg 29	7000.7835.1	7000.7835.2	7000.7835.0
	16,8	53	53	47,5	22 - 32	Pg 36	7000.7836.1	7000.7836.2	7000.7836.0
	16,8	60	60	54,5	32 - 38	Pg 42	7000.7837.1	7000.7837.2	7000.7837.0
	18	68	68	59,8	37 - 44	Pg 48	7000.7838.1	7000.7838.2	7000.7838.0

Technical characteristics	L	Spanner		Panel drilling	Cable Dia	Thread	Part No.	Part No.	Part No.
		SW1	SW2						
	11	16	19	12.5	3 - 6,5	M 12x1,5	7000.7821.6	7000.7821.7	7000.7821.5
	11	19	22	16.5	4 - 8	M 16x1,5	7000.7822.6	7000.7822.7	7000.7822.5
	12,7	24	26	20.5	7 - 12	M 20x1,5	7000.7823.6	7000.7823.7	7000.7823.5
	13	32	33	25.5	11 - 18	M 25x1,5	7000.7824.6	7000.7824.7	7000.7824.5
	14	35	38	32.5	12 - 21	M 32x1,5	7000.7825.6	7000.7825.7	7000.7825.5
	15	53	53	40.5	22 - 32	M 40x1,5	7000.7826.6	7000.7826.7	7000.7826.5
	16,5	60	65	50.5	30 - 38	M 50x1,5	7000.7827.6	7000.7827.7	7000.7827.5
	20	68	70	63.5	35 - 44	M 63x1,5	7000.7828.6	7000.7828.7	7000.7828.5
	11	16	19	12.7	3 - 6,5	Pg 7	7000.7829.6	7000.7829.7	7000.7829.5
	10,2	19	22	15.4	4 - 8	Pg 9	7000.7830.6	7000.7830.7	7000.7830.5
	12,3	22	24	18,8	5 - 10	Pg 11	7000.7831.6	7000.7831.7	7000.7831.5
	13	24	26	20,7	6 - 11	Pg 13.5	7000.7832.6	7000.7832.7	7000.7832.5
	13	27	30	22,8	9 - 13	Pg 16	7000.7833.6	7000.7833.7	7000.7833.5
	15,2	33	36	28,6	13 - 18	Pg 21	7000.7834.6	7000.7834.7	7000.7834.5
	14,5	42	46	37,4	17,5 - 25	Pg 29	7000.7835.6	7000.7835.7	7000.7835.5
	16,8	53	56	47,5	22 - 32	Pg 36	7000.7836.6	7000.7836.7	7000.7836.5
	16,8	60	65	54,5	32 - 38	Pg 42	7000.7837.6	7000.7837.7	7000.7837.5
	18	68	70	59,8	37 - 44	Pg 48	7000.7838.6	7000.7838.7	7000.7838.5

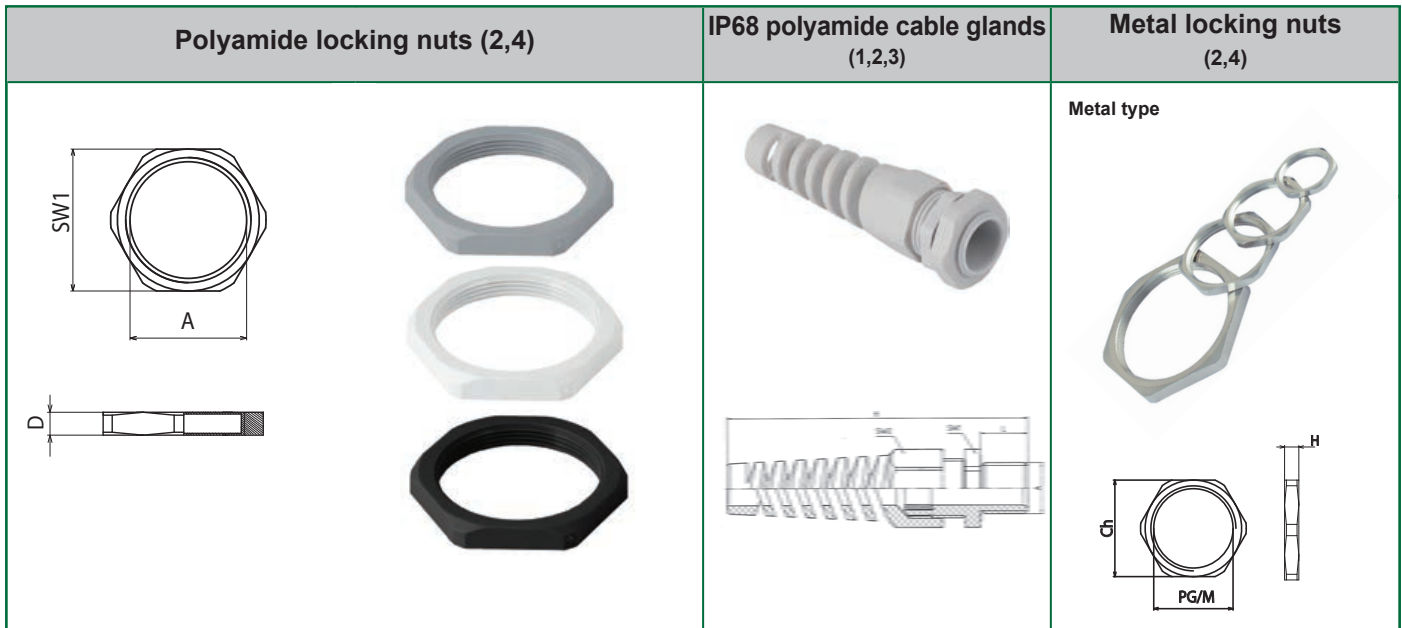

D	SW1	Thread "A"	Part No.	Part No.	Part No.	Size	L	Part No.	H	Thread	Part No.
			Black	Light grey	Grey						Metal type
5	19	M 12x1,5	7000.7841.1	7000.7841.2	7000.7841.0	3 - 6 / 9	M 12x1,5	7000.7122.2	2.80	M 12	7000.6950.0
5	22	M 16x1,5	7000.7842.1	7000.7842.2	7000.7842.0	4 - 8 / 10	M 16x1,5	7000.7123.2	2.80	M 16	7000.6951.0
5,5	26	M 20x1,5	7000.7843.1	7000.7843.2	7000.7843.0	6 - 12,7 / 10,2	M 20x1,5	7000.7124.2	3.00	M 20	7000.6952.0
6	33	M 25x1,5	7000.7844.1	7000.7844.2	7000.7844.0	13 - 18,0 / 12	M 25x1,5	7000.7125.2	3.50	M 25	7000.6953.0
6,5	38	M 32x1,5	7000.7845.1	7000.7845.2	7000.7845.0	3-6 / 9	Pg7	7000.7127.2	4.00	M 32	7000.6954.0
8	53	M 40x1,5	7000.7846.1	7000.7846.2	7000.7846.0	4 - 8 / 9	Pg 9	7000.7128.2	5.00	M40	7000.6955.0
8,5	65	M 50x1,5	7000.7847.1	7000.7847.2	7000.7847.0	5 - 10 / 9	Pg 11	7000.7129.2	5.00	M50	7000.6956.0
9	70	M 63x1,5	7000.7848.1	7000.7848.2	7000.7848.0	6 - 12 / 10	Pg 13.5	7000.7130.2	6.00	M 63	7000.6967.0
5	19	Pg 7	7000.7849.1	7000.7849.2	7000.7849.0	10 - 14 / 10	Pg16	7000.7131.2	2.80	Pg 7	7000.6965.0
5	22	Pg 9	7000.7850.1	7000.7850.2	7000.7850.0	13 - 18 / 12	Pg 21	7000.7132.2	2.80	Pg 9	7000.6966.0
5,5	24	Pg 11	7000.7851.1	7000.7851.2	7000.7851.0				3.00	Pg 11	7000.6957.0
5,5	26	Pg 13.5	7000.7852.1	7000.7852.2	7000.7852.0				3.00	Pg 13.5	7000.6958.0
6	30	Pg 16	7000.7853.1	7000.7853.2	7000.7853.0				3.00	Pg 16	7000.6959.0
6	36	Pg 21	7000.7854.1	7000.7854.2	7000.7854.0				3.50	Pg 21	7000.6960.0
7,5	46	Pg 29	7000.7855.1	7000.7855.2	7000.7855.0				4.00	Pg 29	7000.6961.0
8,5	56	Pg 36	7000.7856.1	7000.7856.2	7000.7856.0				5.00	Pg 36	7000.6962.0
8,5	65	Pg 42	7000.7857.1	7000.7857.2	7000.7857.0				5.00	Pg 42	7000.6963.0
8,5	70	Pg 48	7000.7858.1	7000.7858.2	7000.7858.0				5.50	Pg 48	7000.6964.0

Color:
 Part.No 2 = Grey RAL 7035
 Part.No 0 = Grey RAL 7001
 Part.No 1 = Black

1 - For any sealed enclosures and boxes to protect parts, mechanisms and equipments from atmospheric agents	<p>2 - For more details please consult the Westec General Catalogue</p>	3 - Color Grey or Black. Please replace digit "0" of Part.No. with "1"	4 - For metal and plastic glands and any other metal or polyamide threaded fittings
---	---	--	---

Technical characteristics

Size

Ribbon cable size
a x b

Part No.

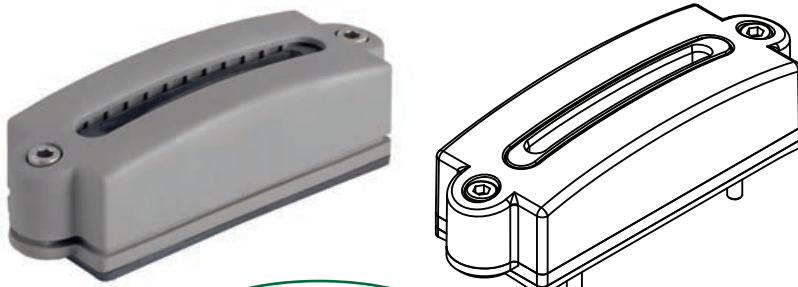

IP66 / IP69K

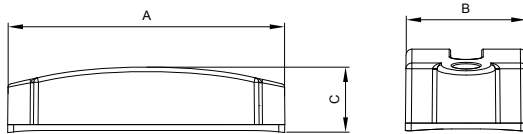

Panel cut out

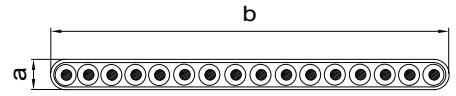
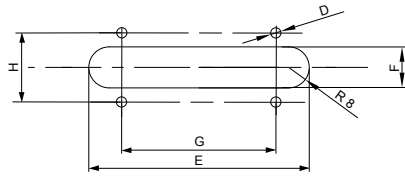

Size	a x b	Part No.
10B	3,8-5,1 x 18-22	7000.7360.0
10B	3,8-5,1 x 27-32	7000.7361.0
16B	3,8-5,1 x 42-46	7000.7370.0
16B	3,8-5,1 x 48-53	7000.7371.0
24B	3,8-5,1 x 62-66	7000.7380.0
24B	4,5-5,7 x 72-76	7000.7381.0

Cable gland for ribbon cables



Patented

IP protection:

IP66 / IP69K

Working temperature:

-40°C ÷ +100°C

Materials:

Pa 66 UL94 V-0

Gaskets:

Silicon

Characteristics

Special design of clamping die, sealing and rubber part prolonging cable life. Waterproof, dustproof, and high resistance to salt, acid, alkali, alcohol, grease and general solvent.

Applications



For sealed enclosures and boxes, where ribbon cable are used



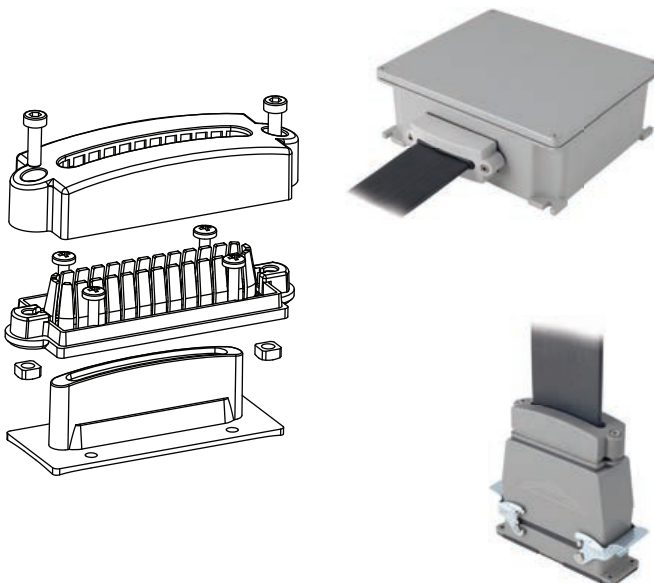

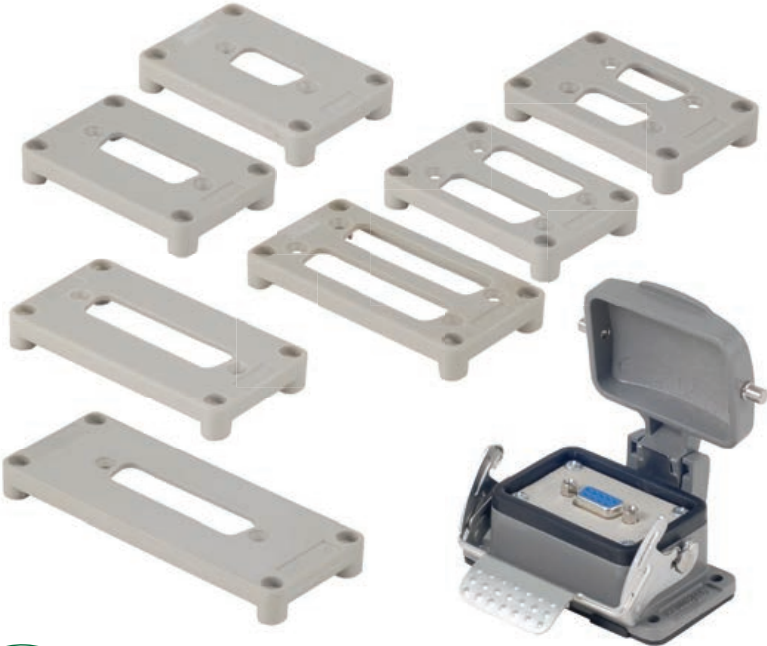
Color: Grey RAL 7037, other colors on request

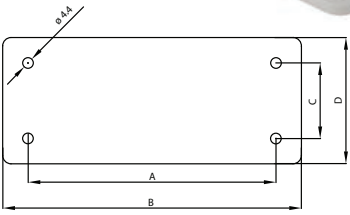
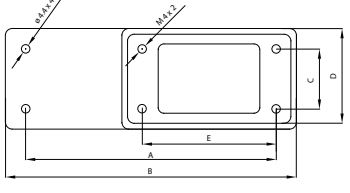



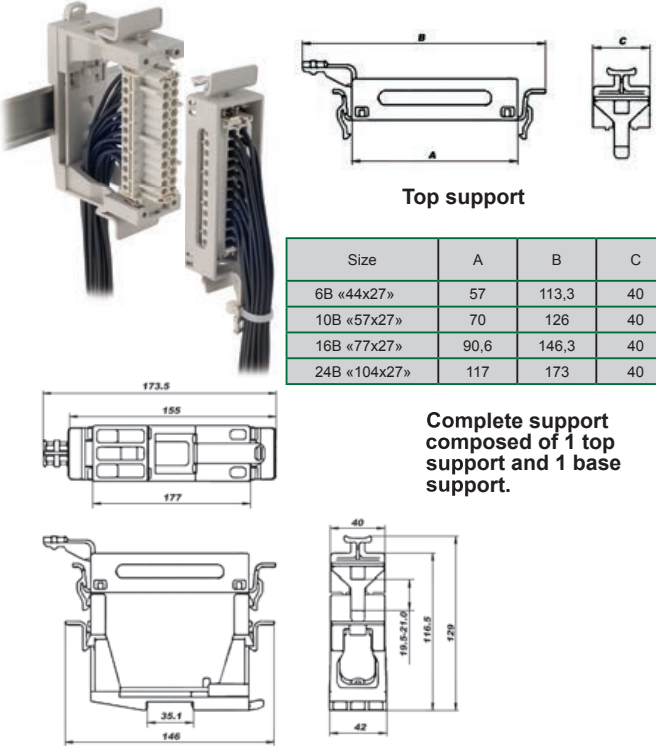

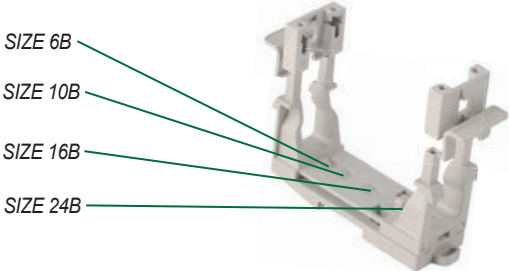





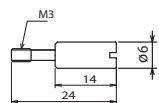





Size	A	B	C	D	E	F	G	H
10B	73	43,5	33	M4	39	16	29	27
16B	93,5	43,5	33	M4	59	16	49	27
24B	120	43,5	33	M4	86	16	60	27



Frame for housings size "B" for D-Sub connectors	D-sub	Size	Part No.
 <p>CE RoHS</p> <p>Applications: housing with cover</p> <p>Plastic frame for housing size 6B, 10B and 16B for D-sub connectors 9, 15 and 25 poles. Grey RAL 7044 Please also consult pages 39, 39, 40 for data connecting interfaces</p>	1 x D-sub 9	6B «44x27»	7000.7060.0
	2 x D-sub 9	6B «44x27»	7000.7061.0
	1 x D-sub 15	6B «44x27»	7000.7062.0
	2 x D-sub 15	6B «44x27»	7000.7063.0
	1 x D-sub 25	10B «57x27»	7000.7065.0
	2 x D-sub 25	10B «57x27»	7000.7066.0
	1 x D-sub 25	16B «77x27»	7000.7067.0

Blanking covers with gasket for bulkhead housings cut-outs	Size	Part No.																												
 <p>CE RoHS</p>  <table border="1" data-bbox="566 1400 1093 1590"> <thead> <tr> <th>Size</th> <th>A</th> <th>B</th> <th>C</th> <th>D</th> </tr> </thead> <tbody> <tr> <td>6B</td> <td>70</td> <td>90,5</td> <td>32</td> <td>52</td> </tr> <tr> <td>10B</td> <td>83</td> <td>103</td> <td>32</td> <td>52</td> </tr> <tr> <td>16B</td> <td>103</td> <td>123,5</td> <td>32</td> <td>52</td> </tr> <tr> <td>24B</td> <td>130</td> <td>150,6</td> <td>32</td> <td>52</td> </tr> </tbody> </table>	Size	A	B	C	D	6B	70	90,5	32	52	10B	83	103	32	52	16B	103	123,5	32	52	24B	130	150,6	32	52	6B «44x27»	7000.7050.0			
	Size	A	B	C	D																									
	6B	70	90,5	32	52																									
	10B	83	103	32	52																									
16B	103	123,5	32	52																										
24B	130	150,6	32	52																										
10B «57x27»	7000.7051.0																													
16B «77x27»	7000.7052.0																													
24B «104x27»	7000.7053.0																													
<p>The covers allow to close the cut out for bulkhead housing on panel if not used.</p>																														
	For bulkhead housing size																													
<p>They allow the use of bulkhead housing with smaller size</p>	 <table border="1" data-bbox="534 1870 1157 2038"> <thead> <tr> <th>Closure size</th> <th>Bulkhead housings</th> <th>A</th> <th>B</th> <th>C</th> <th>D</th> <th>E</th> </tr> </thead> <tbody> <tr> <td>24B «104x27»</td> <td>6B «44x27»</td> <td>130</td> <td>150</td> <td>32</td> <td>52</td> <td>70</td> </tr> <tr> <td>24B «104x27»</td> <td>10B «57x27»</td> <td>130</td> <td>150</td> <td>32</td> <td>52</td> <td>83</td> </tr> <tr> <td>24B «104x27»</td> <td>16B «77x27»</td> <td>130</td> <td>150</td> <td>32</td> <td>52</td> <td>103</td> </tr> </tbody> </table>	Closure size	Bulkhead housings	A	B	C	D	E	24B «104x27»	6B «44x27»	130	150	32	52	70	24B «104x27»	10B «57x27»	130	150	32	52	83	24B «104x27»	16B «77x27»	130	150	32	52	103	6B «44x27» 7000.7054.0 10B «57x27» 7000.7055.0 16B «77x27» 7000.7056.0
Closure size	Bulkhead housings	A	B	C	D	E																								
24B «104x27»	6B «44x27»	130	150	32	52	70																								
24B «104x27»	10B «57x27»	130	150	32	52	83																								
24B «104x27»	16B «77x27»	130	150	32	52	103																								
<p>Thermoplastic material grey RAL 7044</p>																														

Dimensions and materials	Description and advantages																					
 <p>Top support</p> <table border="1" data-bbox="395 544 786 689"> <thead> <tr> <th>Size</th> <th>A</th> <th>B</th> <th>C</th> </tr> </thead> <tbody> <tr> <td>6B «44x27»</td> <td>57</td> <td>113,3</td> <td>40</td> </tr> <tr> <td>10B «57x27»</td> <td>70</td> <td>126</td> <td>40</td> </tr> <tr> <td>16B «77x27»</td> <td>90,6</td> <td>146,3</td> <td>40</td> </tr> <tr> <td>24B «104x27»</td> <td>117</td> <td>173</td> <td>40</td> </tr> </tbody> </table> <p>Complete support composed of 1 top support and 1 base support.</p>	Size	A	B	C	6B «44x27»	57	113,3	40	10B «57x27»	70	126	40	16B «77x27»	90,6	146,3	40	24B «104x27»	117	173	40	<p>This mounting rail system allows you to mount the multipole connectors inserts on the rail inside the control cabinets.</p> <ul style="list-style-type: none"> - No tools are needed and contact inserts are simply snapped in place as well as the support on the rail. - Labelling surfaces on the product allow for clear equipment identification. - For assembling on rail 35x7,5 and 35x15 in accordance with DIN EN60715. - The support enables users to arrange a maximum number of connections in a minimum area within the control cabinet. - Quick locking of the male with female inserts through levers. - Fully compatible: it allows to accept inserts with same sizes not manufactured by Westec. - The inserts can be assembled also with code pins, Part. No. 7000.6875.0/7000.6875.3 male code pin. <p>Application: For all inserts, size: 6B «44x27» 10B «57x27» 16B «77x27» 24B «104x27»</p> <p>For inserts series: S-D, S-DD, S-E, S-EE, S-EHV, S-ES, S-EP, S-ESHV, S-HSB, S-K, S-M</p> <ul style="list-style-type: none"> - Material: Polycarbonate - Color: Grey RAL 7044 - Flammability: UL-94 V0 	
Size	A	B	C																			
6B «44x27»	57	113,3	40																			
10B «57x27»	70	126	40																			
16B «77x27»	90,6	146,3	40																			
24B «104x27»	117	173	40																			
Top support	Description	Part No.																				
	<p>Top support for inserts size 6B «44x27»</p> <p>Top support for inserts size 10B «57x27»</p> <p>Top support for inserts size 16B «77x27»</p> <p>Top support for inserts size 24B «104x27»</p> <p>Removal tool for inserts (see page 52)</p>	<p>7006.7000.0</p> <p>7010.7000.0</p> <p>7016.7000.0</p> <p>7024.7000.0</p> <p>8500.7912.0</p>																				
Base support																						
	<p>Base support plate for inserts size 6B, 10B, 16B, 24B</p>																					
Complete support composed of 1 top support and 1 base support.																						
	<p>Complete set for 6B «44x27» inserts</p> <p>Complete set for 10B «57x27» inserts</p> <p>Complete set for 16B «77x27» inserts</p> <p>Complete set for 24B «104x27» inserts</p> <p>For inserts Series: S-D, S-DD, S-E, S-ES, S-EP, S-EE, S-EHV, S-ESHV, S-HSB, S-K</p>	<p>7006.7009.0</p> <p>7010.7009.0</p> <p>7016.7009.0</p> <p>7024.7009.0</p>																				

Description		Part. No.	Description		Part. No.	
<p>Single code pin</p>  <p>Male code pin</p>  <p>Female code pin</p> 	 <p>Stainless steel</p>	7000.6874.0	<p>Bottom gasket for bulkhead housings</p> <p>- Material: NBR</p> <p>For sizes</p>  <p>3A «21x21» 5871.1896.X</p> <p>10A «49x16» 5121.019X.X</p> <p>16A «66x16» 5121.021X.X</p> <p>32A «66x40» 5121.033X.X</p> <p>6B «44x27» 5871.1904.X</p> <p>10B «57x27» 5871.1938.X</p> <p>16B «77x27» 5871.1854.X</p> <p>24B «104x27» 5871.1995.X</p> <p>32B «77x62» 5871.1987.X</p> <p>48B «104x62» 5871.1961.X</p> <p>QD «32x13» 5871.168X.X</p>	<p>Steel zinc plated</p>	7000.6874.3	
	<p>Stainless steel</p>	7000.6875.0				
	<p>Steel zinc plated</p>	7000.6875.3				
	<p>Stainless steel</p>	7000.6876.0				
	<p>Steel zinc plated</p>	7000.6876.3				
	<p>Technical drawing of male code pin</p> <p>Technical drawing of female code pin</p>					
 <p>Coding cap for female inserts that use 16A contacts. (S-A, S-E, S-EHV series)</p>	5341.2920.0	 <p>⊕ PE screw for inserts: S-A 10A, 16A, S-D15, S-D25</p>		M 3,5	6121.0008.0	
 <p>Coding pin for female inserts that use 10A crimp contacts S-D, S-DD, S-Q12, S-QD17, S-M series</p>	7000.6881.0	<p><i>New</i></p>				
 <p>Coding pin for female inserts that use 16A crimp contacts, S-A, S-E, S-EE, S-EHV, S-Q, S-Q5, S-QD8, S-M series</p>	7000.6882.0	<p><i>New</i></p>		<p>⊕ PE screw for inserts: S-E, S-EE, S-ES, S-EP, S-EHV</p>	M 4	6341.0021.0
 <p>⊕ PE screw for inserts: S-HSB, S-K</p>				M 4	6341.4411.0	
 <p>The identification tags shall be used with the inserts with terminal block S-EAV series.</p>	7000.6886.0	 <p>Inserts fixing screw</p>		M 3	5821.3380.0	
<p>Support for inserts with terminal block on DIN rail</p>  <p>Technical drawing of support for inserts</p>	7400.6836.0	 <p>Contact screw for S-A 3p/4p inserts</p>		M 3	5821.3455.0	
<p>Insert coupling screws for S-EAV inserts</p>  <p>Female</p>	7400.6877.0	 <p>Fixing screw for inserts size 3A, «21x21»</p>	M 3	5821.3463.0		
<p>Male</p>	7400.6878.0	 <p>Single lever 10A</p>	S.S.	5121.102X.X		
 <p>Extension ground terminal</p>	Right	5341.3860.0	 <p>Single lever 16A</p>	S.S.	5121.103X.X	
<p>M4 Assembling screw</p>	Left	5341.3340.0	 <p>Single lever 32A</p>	S.S.	5121.1031.X	
<p>Technical drawing of extension ground terminal</p>		5821.3372.0	<p>Single lever 6B</p>	Zinc P. S.S.	6341.2241.A 5121.2135.X	
			<p>Single lever 10B</p>	Zinc P. S.S.	6341.2092.A 5121.2171.X	
			<p>Single lever 16B</p>	Zinc P. S.S.	6341.0120.A 5131.0514.X	
			<p>Single lever 24B</p>	Zinc P. S.S.	6341.1938.A 5131.0587.X	
			<p>Single lever 48B</p>	Zinc P. S.S.	5341.1039.X 5341.4124.X	
			<p>Double lever 10B, 16B, 24B</p>	Zinc P. S.S.	6341.0138.X 6341.0139.X	
			<p>Double lever 32A</p>	S.S.	5121.120X.X	
			<p>Double lever 32B</p>	Zinc P.	6341.1425.X	
			<p>Single lever 32x13</p>	PA 66	5121.167X.X	

For single conductor

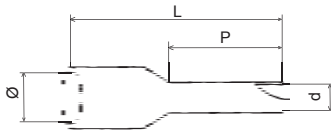

The bush terminals are convenient for connecting stranded wires to connector inserts and terminal blocks with screw terminals. They are in accordance with DIN 46228/4

Materials:
Copper tin plated (insulation - PP)
Colors in accordance DIN STD and French standard

Crimping tools see page 52

Packing	ø	d	P	L	AWG	Wire	Color			Type	Part No.
							DIN	French	German		
	500	2,6	0,8	6	12	22			Orange	S0306	7001.8011.3
	500	2,6	0,8	6	12	22	White	White		S0306	7001.8011.9
	500	2,6	0,8	8	14	22			Orange	S0308	7001.8012.3
	500	2,6	0,8	8	14	22	White	White		S0308	7001.8012.9
	500	2,6	0,8	10	16	22	White	White		S0310	7001.8013.9
	500	2,6	1	6	12	20	White	White		S0506	7001.8001.9
	500	2,6	1	8	14	20	White	White		S0508	7001.8002.9
	500	2,6	1	10	16	20	White	White		S0510	7001.8003.9
	500	2,8	1,2	6	12,4	18			White	S7506	7001.8021.9
	500	2,8	1,2	6	12,4	18	Grey			S7506	7001.8021.8
	500	2,8	1,2	8	14,6	18			White	S7508	7001.8022.9
	500	2,8	1,2	8	14,6	18	Grey			S7508	7001.8022.8
	500	2,8	1,2	10	16,4	18	Grey			S7510	7001.8023.8
	500	2,8	1,2	12	18,4	18			White	S7512	7001.8024.9
	500	2,8	1,2	12	18,4	18	Grey			S7512	7001.8024.8
	500	2,8	1,2	8	14,6	18		Blue		S7508	7001.8022.6
	500	3,0	1,4	6	12,3	17			Yellow	S1006	7001.8031.4
	500	3,0	1,4	6	12,3	17	Red	Red		S1006	7001.8031.2
	500	3,0	1,4	8	14,3	17			Yellow	S1008	7001.8032.4
	500	3,0	1,4	8	14,3	17	Red	Red		S1008	7001.8032.2
	500	3,0	1,4	10	16,3	17	Red	Red		S1010	7001.8033.2
	500	3,0	1,4	12	18,3	17			Yellow	S1012	7001.8034.4
	500	3,0	1,4	12	18,3	17	Red	Red		S1012	7001.8034.2
	500	3,5	1,7	8	14,3	16			Red	S1508	7001.8041.2
	500	3,5	1,7	8	14,3	16	Black	Black		S1508	7001.8041.0
	500	3,5	1,7	10	16,3	16			Red	S1510	7001.8042.2
	500	3,5	1,7	10	16,3	16	Black	Black		S1510	7001.8042.0
	500	3,5	1,7	12	18,3	16	Black	Black		S1512	7001.8043.0
	500	3,5	1,7	18	24,3	16			Red	S1518	7001.8044.2
	500	3,5	1,7	18	24,3	16	Black	Black		S1518	7001.8044.0
	500	4,2	2,3	8	15,4	14	Blue		Blue	S2508	7001.8051.6
	500	4,2	2,3	12	19,4	14	Blue		Blue	S2512	7001.8052.6
	500	4,2	2,3	18	25,4	14	Blue		Blue	S2518	7001.8053.6
	500	4,2	2,3	8	15,4	14		Grey		S2508	7001.8051.8
	500	4,2	2,3	12	19,4	14		Grey		S2512	7001.8052.8
	500	4,2	2,3	18	25,4	14		Grey		S2518	7001.8053.8
	200	4,8	2,8	10	17,4	12	Grey		Grey	S4010	7001.8061.8
	200	4,8	2,8	12	19,4	12	Grey		Grey	S4012	7001.8062.8
	200	4,8	2,8	18	25,4	12	Grey		Grey	S4018	7001.8063.8
	200	4,8	2,8	10	17,4	12		Orange		S4010	7001.8061.3
	200	4,8	2,8	12	19,4	12		Orange		S4012	7001.8062.3
	200	4,8	2,8	18	25,4	12		Orange		S4018	7001.8063.3
	100	6,3	3,5	12	20,5	10			Black	S6012	7001.8071.0
	100	6,3	3,5	12	20,5	10	Yellow			S6012	7001.8071.4
	100	6,3	3,5	18	26,5	10			Black	S6018	7001.8072.0
	100	6,3	3,5	18	26,5	10	Yellow			S6018	7001.8072.4
	100	6,3	3,5	12	20,5	10		Green		S6012	7001.8071.5
	100	6,3	3,5	18	26,5	10		Green		S6018	7001.8072.5



For single conductor - S type

For single conductor



Packing	Ø	D	P	L	AWG	Wire mm ²	Color			Type	Part.No.
							DIN	French	German		
100	7,6	4,5	12	20,8	7	10			White	S1012	7001.8081.9
100	7,6	4,5	12	20,8	7	10	Red			S1012	7001.8081.2
100	7,6	4,5	18	26,8	7	10			White	S1018	7001.8082.9
100	7,6	4,5	18	26,8	7	10	Red			S1018	7001.8082.2
100	7,6	4,5	12	20,8	7	10		Brown		S1012	7001.8081.1
100	7,6	4,5	18	26,8	7	10		Brown		S1018	7001.8082.1
100	8,8	5,8	12	22,0	6	16			Green	S1612	7001.8091.5
100	8,8	5,8	12	22,0	6	16	Blue			S1612	7001.8091.6
100	8,8	5,8	18	28,0	6	16			Green	S1618	7001.8092.5
100	8,8	5,8	18	28,0	6	16	Blue			S1618	7001.8092.6
100	8,8	5,8	12	22,0	6	16		White		S1612	7001.8091.9
100	8,8	5,8	18	28,0	6	16		White		S1618	7001.8092.9
50	11,2	7,5	16	28,0	3	25			Brown	S2516	7001.8101.1
50	11,2	7,5	16	28,0	3	25	Yellow			S2516	7001.8101.4
50	11,2	7,5	22	34,0	3	25			Brown	S2522	7001.8102.1
50	11,2	7,5	22	34,0	3	25	Yellow			S2522	7001.8102.4
50	11,2	7,5	16	28,0	3	25		Black		S2516	7001.8101.0
50	11,2	7,5	22	34,0	3	25		Black		S2522	7001.8102.0
50	12,7	8,6	16	30,0	2	35			Beige	S3516	7001.8111.9
50	12,7	8,6	16	30,0	2	35	Red	Red		S3516	7001.8111.2
50	12,7	8,6	25	39,0	2	35			Beige	S3525	7001.8112.9
50	12,7	8,6	25	39,0	2	35	Red	Red		S3525	7001.8112.2
50	15,0	10,3	20	36,0	1	50			Green	S5020	7001.8121.5
50	15,0	10,3	20	36,0	1	50	Blue	Blue		S5020	7001.8121.6
50	15,0	10,3	25	41,0	1	50			Green	S5025	7001.8122.5
50	15,0	10,3	25	41,0	1	50	Blue	Blue		S5025	7001.8122.6
For double conductor - D type											
500	5,2x2,6	1,5	8	14,5	2x20	2x0,5	White			D0508	7001.8150.9
500	5,2x2,6	1,8	8	14,5	2x18	2x0,75	Grey			D7508	7001.8151.8
500	5,2x2,6	1,8	10	16,7	2x18	2x0,75	Grey			D7510	7001.8152.8
500	5,5x3,2	2,0	8	15,1	2x17	2x1,0	Red			D1008	7001.8161.2
500	5,5x3,2	2,0	10	17,1	2x17	2x1,0	Red			D1010	7001.8162.2
500	6,4x3,6	2,3	8	15,5	2x16	2x1,5	Black			D1508	7001.8171.0
500	6,4x3,6	2,3	12	19,5	2x16	2x1,5	Black			D1512	7001.8172.0
500	8x4,3	2,9	10	18,5	2x14	2x2,5	Blue			D2510	7001.8181.6
500	8x4,3	2,9	13	21,5	2x14	2x2,5	Blue			D2513	7001.8182.6
200	8,8x5,2	3,8	12	23,1	2x12	2x4,0	Grey			D4012	7001.8185.8
100	9,5x7,2	4,9	14	26,1	2x10	2x6,0	Yellow			D6014	7001.8188.4
100	9,5x7,2	6,5	14	26,6	2x7	2x10	Red			D1014	7001.8191.2
100	19x9,5	8,3	14	31,3	2x6	2x16	Blue			D1614	7001.8194.6



Codice colore	Y	Colore	Y	Colore	Y	Colore
7001.8xxx.Y	0	Black/Nero	3	Orange/Arancio	6	Blue/Blu
	1	Brown/Marrone	4	Yellow/Giallo	7	Violet/Viola
	2	Red/Rosso	5	Green/Verde	8	Grey/Grigio
	9	White - Ivory - Beige				

Description	Part.No	Description	Part.No
<p>Complete crimping tool with:</p> <ul style="list-style-type: none"> - Crimping tool - Die set for wire section 0,14 - 4,0 mm² - Locator  <p style="text-align: right;">UL/CSA</p>	8500.7925.0	<p>Removal tool for inserts assembled on DIN rail top support</p> <p>See page 48</p> 	8500.7912.0
<p>Crimping tool with Die set:</p> <ul style="list-style-type: none"> - For wire section 1,6 ÷ 2,5 mm²  <p style="text-align: right;">UL/CSA</p>	8500.7922.0	<p>Removal tool</p> <p>For crimp contacts Dia 1,6 mm (10A) For inserts series S-D, S-DD, etc.</p> 	8500.7940.0
<p>Die set</p> <p>For wire section</p> <ul style="list-style-type: none"> - For : 0,14 ÷ 4,0 mm² - For : 1,5 ÷ 6,0 mm² 	8500.7926.0 8500.7927.0	<p>Removal tool</p> <p>For crimp contacts Dia 2,5 mm (16A) For inserts series S-E, S-EE, etc.</p> 	8500.7945.0
<p>Locator</p> <ul style="list-style-type: none"> - For contacts dia 1,6 ÷ 2,5 mm - For contacts dia 4,0 mm 	8500.7931.0 8500.7932.0	<p>Insertion tool</p> <p>Insertion tool for contacts Dia 1,6 mm (10A), Dia 2,5 mm (16A) For wires 0,14 mm², 1,5 mm² (26 - 18 AWG)</p> 	8500.7948.0
<p>Eight (4+4) indent crimping tool for crimping in accordance with MIL - C - 225 20/1</p>  <p>- Special hand tools for crimping of turned male and female contacts for wire size 0,14 to 6,0 mm (26-10AWG)</p>	8500.7930.0	<p>Professional crimping tool</p> <ul style="list-style-type: none"> - For bush terminals - Automatic self adjustment - Square crimp profile resulting from synchronously driven crimp jaws - To be used for ranges of 0,08 to 10,0 mm² 	8500.7909.0
<p>Economical crimping tool for turned contacts with ratchet:</p>  <ul style="list-style-type: none"> - For wire section 0,5 ÷ 6,0 mm² - For contact Dia 1.6 (10A) Dia 2.5 (16A) Dia 4 (40A) 	8500.6251.0	<p>Professional crimping tool</p> <ul style="list-style-type: none"> - For bush terminals - Automatic self adjustment - Hexagonal crimp profile with six serrated crimp surfaces made by 6 synchronously driven crimp jaws - Cross-section range from 0,08 to 6,0 mm² - Ergonomic design 	8500.7910.0
		<p>Professional crimping tool</p> <ul style="list-style-type: none"> - For bush terminals - Automatic self adjustment - Hexagonal crimp profile with six serrated crimp surfaces made by 6 synchronously driven crimp jaws - Cross-section range from 0,08 to 6,0 mm² - Ergonomic design 	8500.7911.0

Description		Part No.
<p>Manual crimping tool with removable die-set, for single contacts stamped type</p> 		<p>Handle without Die -set 8500.7956.0</p> <p>Die -sets:</p> <p>For wire: 0,14-0,75 mm² 26-18 AWG 8500.7957.0</p> <p>For wire: 1-2,5 mm² 17-14 AWG 8500.7958.0</p>
<p>Manual crimping tool for stamped contacts on reel</p> 		<p>For contacts</p> <p>Features</p> <ul style="list-style-type: none"> - Tool with feeding and cutting device excellent for contacts on reel. - Crimping wire and insulation in one step - Simple contact positioning - Integrated ratcheted ensures complete crimping <p>0,14-0,5 mm² 26-20 AWG 8500.7972.0</p> <p>0,5-1 mm² 20-17 AWG 8500.7973.0</p> <p>1,5-2,5 mm² 16-14 AWG 8500.7974.0</p>
<p>Semiautomatic crimping press with mini applicator for stamped contacts.</p> 		<p>Crimping machine 8500.7982.0</p> <p>Mini-applicator with crimper for wire:</p> <p>0,14-0,75 mm² 26-18 AWG 8500.7984.0</p> <p>0,75-2,5 mm² 18-14 AWG 8500.7986.0</p>
<p>Crimping toggle press MODEL GW12KN For turned contacts</p> 	<p>Pneumatic crimping machine MODEL GW25KN For turned contacts</p> 	<p>Toggle press without crimping die set 8500.7970.0</p> <p>Toggle press with crimping die set and locator for turned contacts for wire section 0,14 to 4,0 mm² 8500.7971.0</p> <p>Pneumatic crimping machine without crimping dies 8500.7980.0</p> <p>For more details please consult the Westec General Catalogue</p>

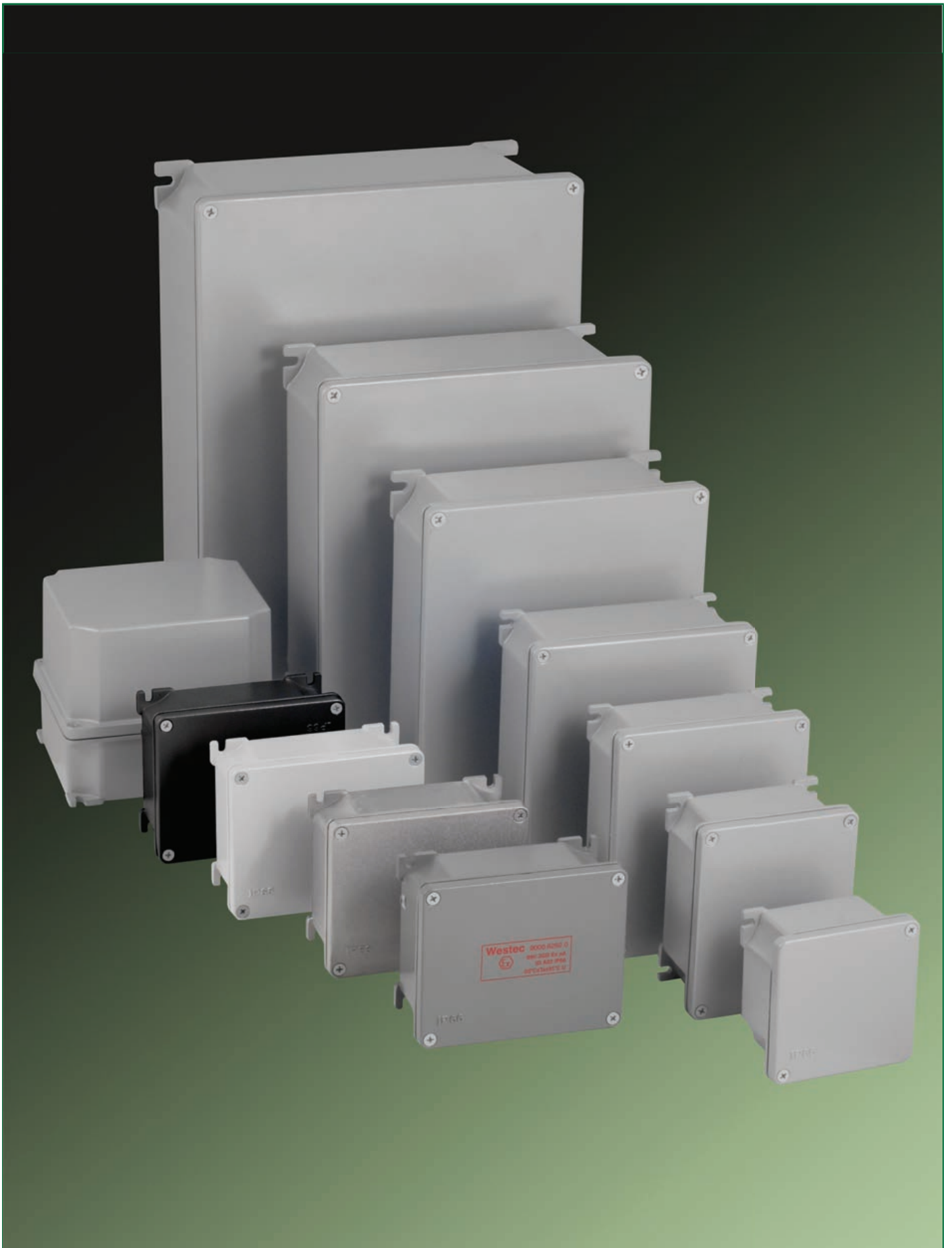

General technical characteristics and applications



- Metal enclosures for installation, circuit breaking, connection and control of electric and electronic equipments.
- For industries, automotive, railways, navy, tunnels, parkings, industrial buildings
- The enclosures are in conformance with the Low Voltage Directive 2006/95/EC, with EMC Directive 2004/108/EC where applicable and with the Standards:

EN 60670-1	Boxes and enclosures for electrical accessories for household and similar fixed electrical installation.
EN 60670-22	Particular requirements for connecting boxes and enclosures.
EN 62208	Empty enclosures for low voltage switchgear and controlgear assemblies.
NEMA 250	National (USA) Electrical Manufacturers Association. Class (Type) of protection.

- High mechanical strength and vibration resistance.
- Captive screws
- High protection against magnetic interferences
- Anti-ageing materials, water resistant, oil resistant, grease resistant and fuel resistant.
- The enclosures can be mounted by using external flanges or internally through holes.
- Inside the boxes the DIN rail or the metal plate, supplied as accessory, can be assembled for mounting terminal blocks, breakers, fuse holders, control devices, transformers, electronic circuits, connectors, etc.
- 6 series are available:
 - 1 - Standard with polyester powder coating grey RAL9006
 - 2 - Standard with polyester powder coating grey RAL7035
 - 3 - Standard with polyester powder coating grey RAL7037
 - 4 - Sandblasted without coating
 - 5 - EMC series. Sandblasted without coating.
 - 6 - HE type for harsh environmental and for high temperature up to 210°C.
Black RAL9005 with polyester powder coating

- The enclosures HE series have the best performances of the enclosures HE series for the MIC connectors: These performances are listed on pages 18.05, 18.15 and 18.16 of Westec General Catalogue.

- 8 sizes are available:
 - from 90 x 90 x 53 mm, size 1 (S1)
 - to 392 x 298 x 144 mm, size 7 (S7)
 - Size S-3 with high cap (HC)

- Protection degree according to EN 60529: IP66

- Protection degree according to NEMA 250: Type 4,4x,12,13
Type 4x, with coated surfaces only

- Working temperature: - 40°C ÷ + 125°C (210°C HE Type)

- With ground terminal on box and on cover by using trilobate screw for better ground contacts and low electrical resistance

- Not coated internally to guarantee the electrical conductivity of the internal surface for better ground protection

• Materials

- Body and cover: - Die-cast aluminium alloy
- Colors:
 - Type STD Grey RAL 9006
 - Type STD Grey RAL 7035
 - Type STD Grey RAL 7037
 - Type HE Black RAL 9005
 - Type sandblasted Al naural color
 - EMC: Al naural color
- Coating: - Polyester powder
- Gaskets: - In anti-ageing, oils, greases and fuel resistant silicone
- Screws:
 - Steel with Geomet® treatment to prevent corrosion especially with aluminium parts
 - Steel zinc plated for screws used internally
- Metal plates: - Steel zinc plated

Technical characteristics and applications of ATEX versions



- Metal enclosures for installation, circuit breaking, connection and control of electric and electronic equipments.
- For industries, automotive, railways, navy, tunnels, parkings, industrial buildings
- ATEX versions are in conformance with the European Directive 94/9/EC and to the Standards:

EN 60079-0:	General apparatus for explosive gas atmosphere Part 0: General requirements.
EN 60079-1-10:	Enclosures for explosive atmosphere. Class of the zone.
EN 60079-15:	Electrical apparatus for explosive gas atmospheres. Construction, testing and marking.
EN 61241-1-10:	Electrical apparatus in the presence of combustible dust. Part. 1-1: Electrical apparatus protected by enclosures - Construction and testing. Part 10: Class of zone.

- High mechanical strength and vibration resistance.
- Captive screws
- High protection against magnetic interferences
- Anti-ageing materials, water resistant, oil resistant, grease resistant and fuel resistant.
- The enclosures can be mounted by using external flanges or internally through holes.
- Inside the boxes the DIN rail or the metal plate, supplied as accessory, can be assembled for mounting terminal blocks, breakers, fuse holders, control devices, transformers, electronic circuits, connectors, etc.
- 8 sizes are available
- Degree of protection according to EN 60529: IP66
- Working temperature in accordance with ATEX: -20°C ÷ +85°C
- With ground terminal on box and on cover by using trilobate screws for better ground contacts and low electrical resistance
- Not coated internally to guarantee the electrical conductivity of the internal surface for better ground protection
- Materials:
 - Metal body and cover: - Die-cast aluminium alloy (AlSi 12)
 - Color: - Grey RAL 7037
 - Coating: - Polyester powder
 - Gaskets: in anti-ageing, oil, greases and fuel resistant silicone
 - Screws: - Steel with Geomet® treatment to prevent corrosion especially with aluminium parts
- Steel zinc plated for screws used internally
 - Metal plates: - Steel zinc plated

Marking:

Westec	8000.6291.0
	YY II 3GD Ex nA
	tD A22 IP66
	-20°C ≤ Ta ≤ 85°C U



Junction box in accordance with European Directive 94/9/CE

Marking data classification

YY
Year of manufacturing

Ex
Product for use in explosive atmospheres, in accordance with EN Standards

II
Group II product - only for areas different from mines.

3GD
Category 3 products for areas containing gas (G) and dust (D) with normal risk of explosion.
In particular, the product can only be installed:
a) in zone 2 (where it is improbable that an explosive atmosphere of air and flammable substances will form during normal working activity).
b) in zone 22 (where it is improbable that an explosive atmosphere of dust will form, and if so, it will be short-lasting).

nA
nA protection method in accordance with EN 60079-15 (gas).
The components supplied by Westec are classified as type nA by Standard EN 60079-15 so they can only house components of non-sparking type.

tD
tD protection method in accordance with EN 61241-1 (Dusts)

A22
The products supplied by Westec are tested pursuant to Method A provided by EN 61241-1 Standard and are therefore suitable for installation in zone 22.

Ta
Permitted ambient temperature field: -20°C ÷ +85°C

IP66
The lighting fixture's protection level against the ingress of solids and liquids, in accordance with EN 60529

U
The junction boxes are components for the purposes of Directive 94/9/EEC so the finished product must be certified by the end user manufacturer.

GENERAL REMARKS

- The plant engineer/client is responsible for classifying areas where hazardous atmospheres can form in order to choose the right product.
- The component supplied by Westec **are only suitable in zone 2 (GAS) and 22 (DUST)**.
- The components must be installed in a thoroughly workmanlike way following the manufacturer's instructions.
- Make the internal and supplementary external earth connections in correspondence with the earth symbol.
- The components supplied by Westec are classified as type nA as per standard EN 60079-15, so they can only contain non sparking components.
- The junction boxes are components within the meaning of European Directive 94/9/EEC so finished products must be certificated by the end manufacturer.
- Use only ATEX certified cable glands with appropriate level of protection and suitable for being installed in zones classified as 2 (GAS) and 22 (DUST).
- The number and the size of the holes are limited by the ATEX Standard. Please see the table on page 58

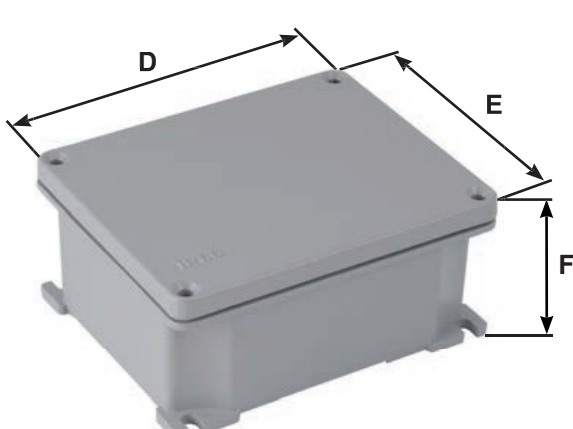
Description and dimensions					Type / color	IP protection	Size	Part. No.
					STD/RAL9006	IP66	S1	8000.6261.0
					STD/RAL9006	IP66	S2	8000.6262.0
					STD/RAL9006	IP66	S3	8000.6263.0
					STD/RAL9006	IP66	S4	8000.6264.0
					STD/RAL9006	IP66	S5	8000.6265.0
					STD/RAL9006	IP66	S6	8000.6266.0
					STD/RAL9006	IP66	S7	8000.6267.0
					STD/RAL9006	IP66	S3 - HC	8000.6268.0
					STD/RAL7035	IP66	S1	8000.6261.2
					STD/RAL7035	IP66	S2	8000.6262.2
					STD/RAL7035	IP66	S3	8000.6263.2
					STD/RAL7035	IP66	S4	8000.6264.2
					STD/RAL7035	IP66	S5	8000.6265.2
					STD/RAL7035	IP66	S6	8000.6266.2
					STD/RAL7035	IP66	S7	8000.6267.2
					STD/RAL7035	IP66	S3 - HC	8000.6268.2
					STD/RAL7037	IP66	S1	8000.6261.3
					STD/RAL7037	IP66	S2	8000.6262.3
					STD/RAL7037	IP66	S3	8000.6263.3
					STD/RAL7037	IP66	S4	8000.6264.3
					STD/RAL7037	IP66	S5	8000.6265.3
					STD/RAL7037	IP66	S6	8000.6266.3
					STD/RAL7037	IP66	S7	8000.6267.3
					STD/RAL7037	IP66	S3 - HC	8000.6268.3
					Sandblasted	IP66	S1	8000.6281.0
					Sandblasted	IP66	S2	8000.6282.0
					Sandblasted	IP66	S3	8000.6283.0
					Sandblasted	IP66	S4	8000.6284.0
					Sandblasted	IP66	S5	8000.6285.0
					Sandblasted	IP66	S6	8000.6286.0
Sandblasted	IP66	S7	8000.6287.0					
Sandblasted	IP66	S3 - HC	8000.6288.0					
EMC	IP66	S1	8000.6281.4					
EMC	IP66	S2	8000.6282.4					
EMC	IP66	S3	8000.6283.4					
EMC	IP66	S4	8000.6284.4					
EMC	IP66	S5	8000.6285.4					
EMC	IP66	S6	8000.6286.4					
EMC	IP66	S7	8000.6287.4					
EMC	IP66	S3 - HC	8000.6288.4					
ATEX/RAL7037	IP66	S1	8000.6291.0					
ATEX/RAL7037	IP66	S2	8000.6292.0					
ATEX/RAL7037	IP66	S3	8000.6293.0					
ATEX/RAL7037	IP66	S4	8000.6294.0					
ATEX/RAL7037	IP66	S5	8000.6295.0					
ATEX/RAL7037	IP66	S6	8000.6296.0					
ATEX/RAL7037	IP66	S7	8000.6297.0					
ATEX/RAL7037	IP66	S3 - HC	8000.6298.0					
HE/RAL9005	IP66	S1	8000.6261.1					
HE/RAL9005	IP66	S2	8000.6262.1					
HE/RAL9005	IP66	S3	8000.6263.1					
HE/RAL9005	IP66	S4	8000.6264.1					
HE/RAL9005	IP66	S5	8000.6265.1					
HE/RAL9005	IP66	S6	8000.6266.1					
HE/RAL9005	IP66	S7	8000.6267.1					
HE/RAL9005	IP66	S3 - HC	8000.6268.1					

Size	Internal dimensions	Outside dimensions			Packing
		D	E	F	
S1	91 x 91 x 53	101	101	58	1/40
S2	128 x 103 x 55	138,5	113,5	61,5	1/32
S3	154 x 129 x 58	165,5	140,5	63,5	1/24
S3 - HC	154 x 129 x 130,8	165,5	140,5	136,8	1/8
S4	178 x 155 x 74	189	167	80	1/16
S5	239 x 202 x 85	252	215	91	1/8
S6	294 x 244 x 114	307	257	120,5	1/4
S7	392 x 298 x 144	406,5	312,5	151	1

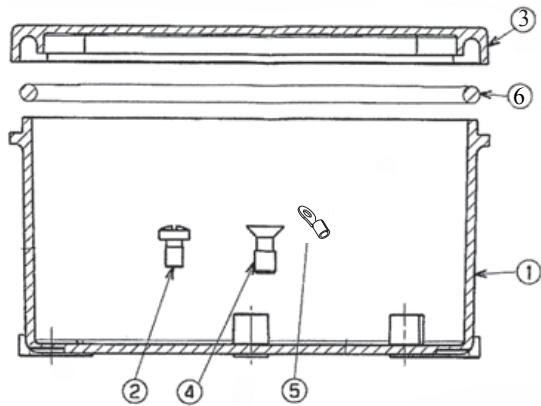

1	Bottom
2	Screw for ground terminal
3	Cover
4	Screw for cover
5	Ground terminal
6	Gasket

- For ATEX: Supplementary ground screw + terminal

NEMA 250: *Type 4,4x,12,13*
Sandblasted box Type 4,12,13

Power dissipation		In accordance with EN60670-24 and CEI 23-49 standard
Size	Watt	
S1	8	
S2	12	
S3	17	
S4	21	
S5	35	
S6	50	
S7	69	
S3 - HC	22	

Dimensions

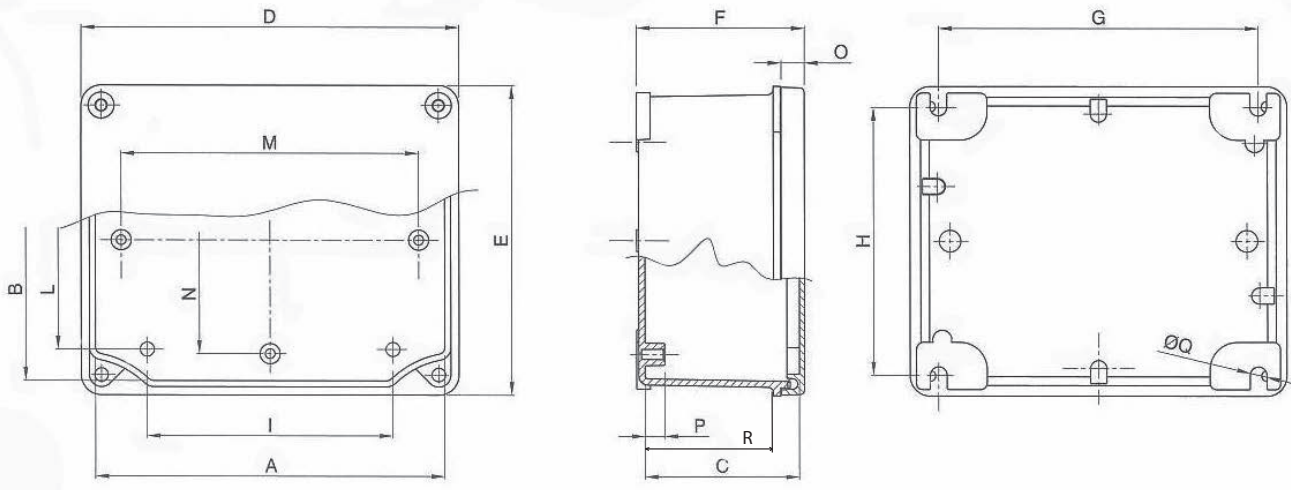

Size	A	B	C	D	E	F	G	H	I	L	M	N	O	P	Q	R
S1	91	91	53	101	101	58	88	80	52,5	42,5			8,3	7,5	6,1	42
S2	128	103	55	138,5	113,5	61,5	120	100	60	50	109		8,5	7,3	6,1	45
S3	154	129	58	165,5	140,5	63,5	144	125	104,5	102	135	110	8,6	7,2	6,1	47
S3-HC	154	129	130,8	165,5	140,5	136,8	144	125	104,5	102	135	110	81,9	7,2	6,1	47
S4	178	155	74	189	167	80	168	149	117	129,5	140	120	8,7	7,1	6,1	62
S5	239	202	85	252	215	91	226	196	178	164	208	168	9	8,7	8,7	72
S6	294	244	114	307	257	120,5	275	236	208	193,5	256	210	9,2	8,5	8,7	102
S7	392	298	149	406,5	312,5	156	367	283	290	237	320	230	14,8	8,5	8,7	131

Drilling in conformity with ATEX requirements

Boxes	Size	Long side				Short side				Max No.of drilling per box
		Dia	M Metric	Pg	No. of drilling Numero fori	Dia	M Metric	Pg	No. of drilling	
8000.6291.0	S1	20,5	20		1	20,5	20		1	4
		23		16		23		16		
8000.6292.0	S2	25,5	25		1	25,5	25		1	4
		29		21		28,8		21		
8000.6293.0	S3	25,5	25		2	25,5	25		1	6
8000.6298.0	S3 - HC	28,8		21		28,8		21		
8000.6294.0	S4	32,5	32		2	32,5	32		2	8
		37,5		29		37,5		29		
8000.6295.0	S5	40,5	40		2	40,5	40		2	8
		47,5		36		47,5		36		
8000.6296.0	S6	63,5	63		2	63,5	63		2	8
		60		48		60		48		
8000.6297.0	S7	63,5	63		3	63,5	63		2	10
		60		48		60		48		

Important note: We can supply the enclosures drilled with or without cable glands and fittings in accordance with customer requirements

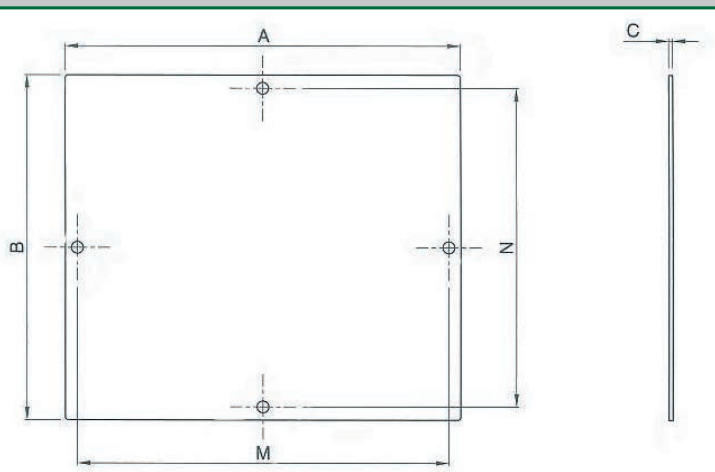
Metal plates for metal enclosures	Packing	For box size	Part No.																																										
	1/10	S2	8000.6272.0																																										
	1/10	S3	8000.6273.0																																										
	1/10	S4	8000.6274.0																																										
	1/5	S5	8000.6275.0																																										
	1/5	S6	8000.6276.0																																										
	1/5	S7	8000.6277.0																																										
	<table border="1"> <thead> <tr> <th>Size</th> <th>A</th> <th>B</th> <th>C</th> <th>M</th> <th>N</th> </tr> </thead> <tbody> <tr> <td>S2</td> <td>118,5</td> <td>78,5</td> <td>1,5</td> <td>109</td> <td></td> </tr> <tr> <td>S3</td> <td>144</td> <td>119</td> <td>1,5</td> <td>135</td> <td>110</td> </tr> <tr> <td>S4</td> <td>165</td> <td>130</td> <td>1,5</td> <td>140</td> <td>120</td> </tr> <tr> <td>S5</td> <td>219</td> <td>179</td> <td>1,5</td> <td>208</td> <td>168</td> </tr> <tr> <td>S6</td> <td>267</td> <td>221</td> <td>1,5</td> <td>256</td> <td>210</td> </tr> <tr> <td>S7</td> <td>345</td> <td>260</td> <td>1,5</td> <td>320</td> <td>230</td> </tr> </tbody> </table>	Size	A	B	C	M	N	S2	118,5	78,5	1,5	109		S3	144	119	1,5	135	110	S4	165	130	1,5	140	120	S5	219	179	1,5	208	168	S6	267	221	1,5	256	210	S7	345	260	1,5	320	230		
Size	A	B	C	M	N																																								
S2	118,5	78,5	1,5	109																																									
S3	144	119	1,5	135	110																																								
S4	165	130	1,5	140	120																																								
S5	219	179	1,5	208	168																																								
S6	267	221	1,5	256	210																																								
S7	345	260	1,5	320	230																																								

Threelobated screws M4x8 for DIN rails and metal plates	100		5631.3836.X
Threelobated screws M5x10 for DIN rails and metal plates	100		5631.3869.X
Screw kit for S1 enclosures	1		5691.1836.X
Screw kit for S2 - S4 enclosures	1		5691.1844.X
Screw kit for S5 - S7 enclosures	1		5691.1851.X
Screw kit for ATEX enclosures	1		5691.1869.X



Size, S3-HC ATEX

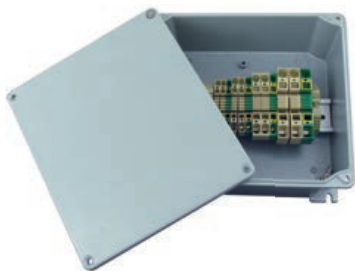

Size, S5

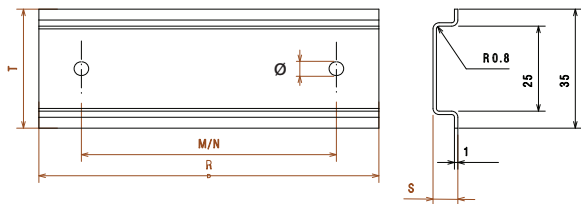

DIN rail with included fixing screws

Material: steel zinc plated

T	S	R	N	M	Ø	size	Part No.
35	7,5	118,5	-	109	4,5	S2	8000.6252.0
35	7,5	144	-	135	4,5	S3	8000.6253.0
35	7,5	119	110	-	4,5	S3	8000.6253.3
35	7,5	165	-	140	4,5	S4	8000.6254.0
35	7,5	130	120	-	4,5	S4	8000.6254.3
35	7,5	219	-	208	5,5	S5	8000.6255.0
35	7,5	179	168	-	5,5	S5	8000.6255.3
35	7,5	267	-	256	5,5	S6	8000.6256.0
35	7,5	221	210	-	5,5	S6	8000.6256.3
35	7,5	345	-	320	5,5	S7	8000.6257.0
35	7,5	260	230		5,5	S7	8000.6257.3



General technical characteristics and applications



- Metal enclosures for installation, circuit breaking, connection and control of electric and electronic equipments.

- For mechanical and electromechanical industries, industrial automation, automotive, railways, navy, tunnels, parkings, industrial buildings

- The enclosures are in conformance with the Low Voltage Directive 2006/95/EC, with EMC Directive 2004/108/EC where applicable and with the Standards:

EN 62208 Empty enclosures for low voltage switchgear and controlgear assemblies

NEMA 250 National (USA) Electrical Manufacturers Association. Class (Type) of protection.

DIN 40050-9 / ISO 20653: Electrical equipments in road vehicles. Enclosures. Water test with high pressure. IP69K.

NEMA ICS5: Food and beverage industries. High pressure power wash test procedure for self contained control-circuit devices.

- High mechanical strength and vibration resistance.

- Captive screws

- High protection against magnetic interferences

- Anti-ageing materials, water resistant, oil resistant, grease resistant and fuel resistant.

- The enclosures can be mounted internally through holes

- Inside the boxes the DIN rail or the metal plate can be assembled for mounting terminal blocks, breakers, fuse holders, control devices, transformers, electronic circuits, connectors, etc.

- 5 series are available:

- 1 - Standard with polyester powder coating grey RAL 7001
- 2 - Standard with polyester powder coating grey RAL 7035
- 3 - Standard sandblasted without coating.
- 4 - EMC series. Sandblasted without coating. Pls refer to note of page 18.06
- 5 - HE type for harsh environmental and for high temperature up to 210°C. Black RAL 9005 with polyester powder coating

- The enclosures HE series have the best performances of the enclosures HE series for the MIC connectors: These performances are listed in the Westec General Catalogue.

- Protection degree according to EN 60529: IP66

- Protection degree according DIN 40050-9: IP69K

- Protection degree according NEMA 250: Type 4,4x,12,13 Type 4x, with coated surfaces only

- Impact resistance EN 62262: IK 09

- Working temperature: - 40°C ÷ + 125°C (+210°C HE Type)

- Max ambient temperature: 75°C

Ambient temperature average value over 24h: 60°C

- Max relative humidity at 25°C: 100%

Max relative humidity at 40°C: 50%

- With ground terminal on box and on cover

- Materials

- Metal body and cover: Die-cast aluminium alloy

- Coating: - Polyester powder coating

- Gaskets: in anti-ageing, oil resistant and fuel resistant silicone

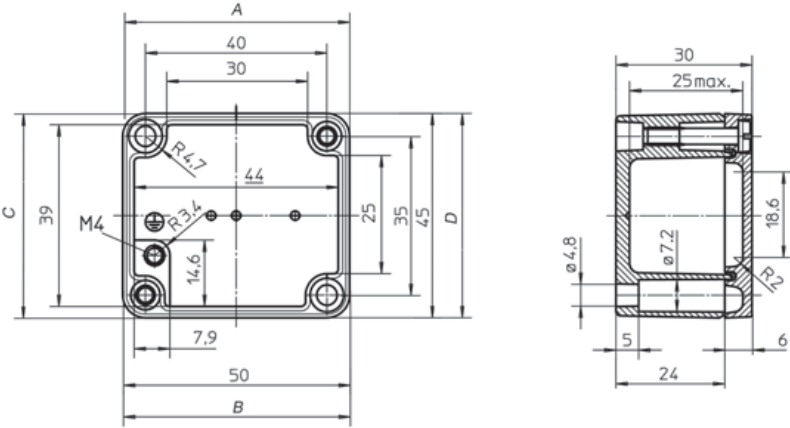

- Screws: - Stainless steel

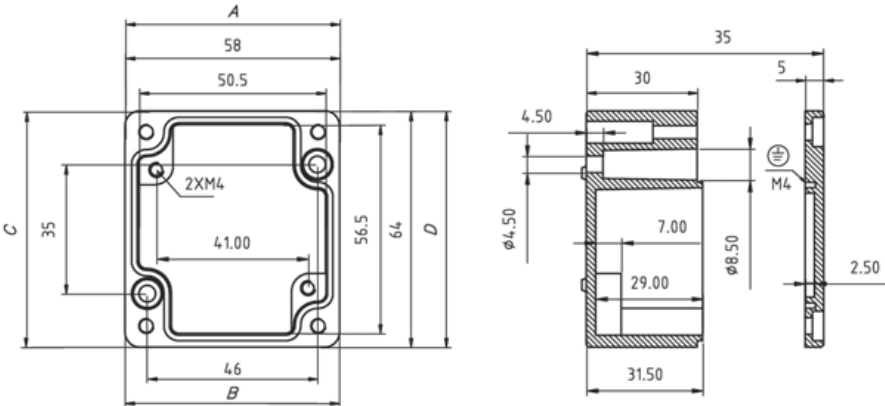

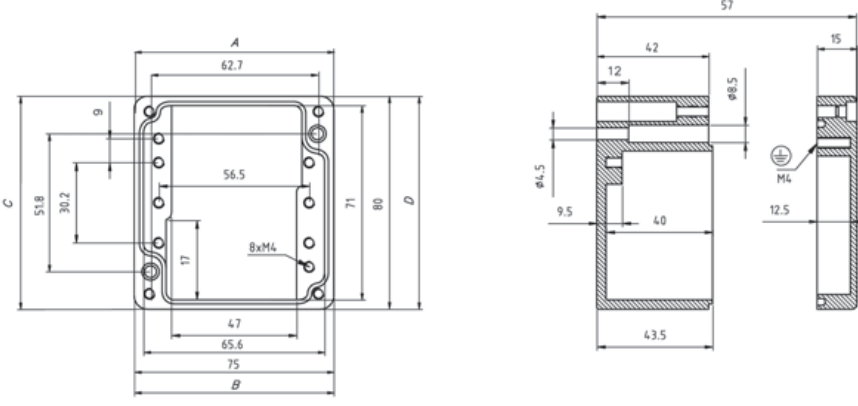
Model	05.05.03	Outside dimensions	50 x 45 x 30 mm	Color	Part No.																																													
 <p style="text-align: center;">IP66 / IP69K</p> <p style="text-align: right;">CE RoHS</p> <p>NEMA 250: Type 4,4x,12,13 Sandblasted enclosures Type 4,12,13</p> <table border="1"> <thead> <tr> <th colspan="10">MAX M Thread</th> </tr> <tr> <th>M</th> <th>12</th> <th>16</th> <th>20</th> <th>25</th> <th>32</th> <th>40</th> <th>50</th> <th>63</th> <th></th> </tr> </thead> <tbody> <tr> <td>Side A/B</td> <td>1</td> <td>0</td> <td>0</td> <td>0</td> <td>0</td> <td>0</td> <td>0</td> <td>0</td> <td>0</td> </tr> <tr> <td>Side C/D</td> <td>1</td> <td>0</td> <td>0</td> <td>0</td> <td>0</td> <td>0</td> <td>0</td> <td>0</td> <td>0</td> </tr> </tbody> </table>	MAX M Thread										M	12	16	20	25	32	40	50	63		Side A/B	1	0	0	0	0	0	0	0	0	Side C/D	1	0	0	0	0	0	0	0	0	Grey RAL7001	8100.8005.0	Grey RAL7035	8100.8105.0	Sandblasted	8100.8205.0	EMC	8100.8205.4	HE Black RAL 9005	8100.8305.1
	MAX M Thread																																																	
	M	12	16	20	25	32	40	50	63																																									
	Side A/B	1	0	0	0	0	0	0	0	0																																								
	Side C/D	1	0	0	0	0	0	0	0	0																																								

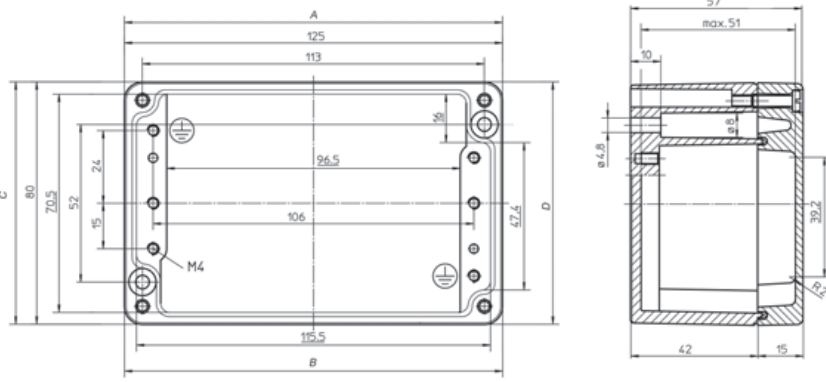
Model	06.06.03	Outside dimensions	58 x 64 x 36 mm	Color	Part No.																																													
 <p style="text-align: center;">IP66 / IP69K</p> <p style="text-align: right;">CE RoHS</p> <p>NEMA 250: Type 4,4x,12,13 Sandblasted enclosures Type 4,12,13</p> <table border="1"> <thead> <tr> <th colspan="10">MAX M Thread</th> </tr> <tr> <th>M</th> <th>12</th> <th>16</th> <th>20</th> <th>25</th> <th>32</th> <th>40</th> <th>50</th> <th>63</th> <th></th> </tr> </thead> <tbody> <tr> <td>Side A/B</td> <td>2</td> <td>0</td> <td>0</td> <td>0</td> <td>0</td> <td>0</td> <td>0</td> <td>0</td> <td>0</td> </tr> <tr> <td>Side C/D</td> <td>1</td> <td>0</td> <td>0</td> <td>0</td> <td>0</td> <td>0</td> <td>0</td> <td>0</td> <td>0</td> </tr> </tbody> </table>	MAX M Thread										M	12	16	20	25	32	40	50	63		Side A/B	2	0	0	0	0	0	0	0	0	Side C/D	1	0	0	0	0	0	0	0	0	Grey RAL7001	8100.8006.0	Grey RAL7035	8100.8106.0	Sandblasted	8100.8206.0	EMC	8100.8206.4	HE Black RAL 9005	8100.8306.1
	MAX M Thread																																																	
	M	12	16	20	25	32	40	50	63																																									
	Side A/B	2	0	0	0	0	0	0	0	0																																								
	Side C/D	1	0	0	0	0	0	0	0	0																																								

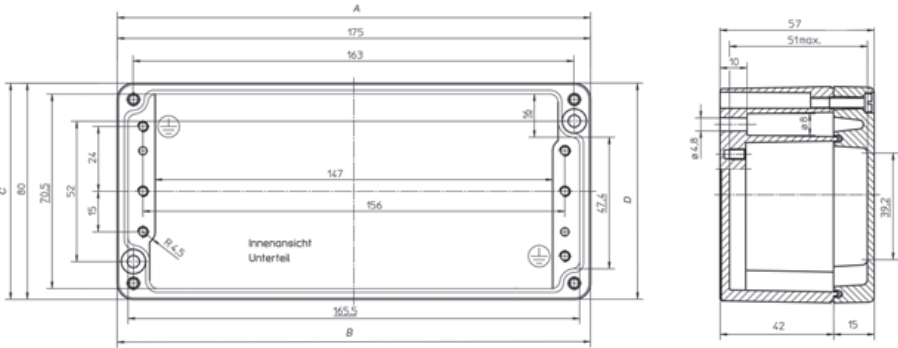
Model	08.08.06	Outside dimensions	80 x 75 x 57 mm	Color	Part No.																																					
 <p style="text-align: center;">IP66 / IP69K</p> <p style="text-align: center;">CE RoHS</p> <p>NEMA 250: Type 4,4x,12,13 Sandblasted enclosures Type 4,12,13</p> <table border="1"> <thead> <tr> <th colspan="2">MAX M Thread</th> <th>12</th> <th>16</th> <th>20</th> <th>25</th> <th>32</th> <th>40</th> <th>50</th> <th>63</th> </tr> </thead> <tbody> <tr> <td>M</td> <td></td> <td>12</td> <td>16</td> <td>20</td> <td>25</td> <td>32</td> <td>40</td> <td>50</td> <td>63</td> </tr> <tr> <td>Side</td> <td>A/B</td> <td>5</td> <td>2</td> <td>1</td> <td>0</td> <td>0</td> <td>0</td> <td>0</td> <td>0</td> </tr> <tr> <td>Side</td> <td>C/D</td> <td>3</td> <td>2</td> <td>1</td> <td>0</td> <td>0</td> <td>0</td> <td>0</td> <td>0</td> </tr> </tbody> </table>	MAX M Thread		12	16	20	25	32	40	50	63	M		12	16	20	25	32	40	50	63	Side	A/B	5	2	1	0	0	0	0	0	Side	C/D	3	2	1	0	0	0	0	0	Grey RAL7001	8100.8009.0
	MAX M Thread		12	16	20	25	32	40	50	63																																
	M		12	16	20	25	32	40	50	63																																
	Side	A/B	5	2	1	0	0	0	0	0																																
	Side	C/D	3	2	1	0	0	0	0	0																																
Grey RAL7035	8100.8109.0																																									
Sandblasted	8100.8209.0																																									
EMC	8100.8209.4																																									
HE Black RAL 9005	8100.8309.1																																									

Model	13.08.06	Outside dimensions	125 x 80 x 57 mm	Color	Part No.																																					
 <p style="text-align: center;">IP66 / IP69K</p> <p style="text-align: center;">CE RoHS</p> <p>NEMA 250: Type 4,4x,12,13 Sandblasted enclosures Type 4,12,13</p> <table border="1"> <thead> <tr> <th colspan="2">MAX M Thread</th> <th>12</th> <th>16</th> <th>20</th> <th>25</th> <th>32</th> <th>40</th> <th>50</th> <th>63</th> </tr> </thead> <tbody> <tr> <td>M</td> <td></td> <td>12</td> <td>16</td> <td>20</td> <td>25</td> <td>32</td> <td>40</td> <td>50</td> <td>63</td> </tr> <tr> <td>Side</td> <td>A/B</td> <td>10</td> <td>4</td> <td>3</td> <td>2</td> <td>0</td> <td>0</td> <td>0</td> <td>0</td> </tr> <tr> <td>Side</td> <td>C/D</td> <td>3</td> <td>2</td> <td>1</td> <td>0</td> <td>0</td> <td>0</td> <td>0</td> <td>0</td> </tr> </tbody> </table>	MAX M Thread		12	16	20	25	32	40	50	63	M		12	16	20	25	32	40	50	63	Side	A/B	10	4	3	2	0	0	0	0	Side	C/D	3	2	1	0	0	0	0	0	Grey RAL7001	8100.8010.0
	MAX M Thread		12	16	20	25	32	40	50	63																																
	M		12	16	20	25	32	40	50	63																																
	Side	A/B	10	4	3	2	0	0	0	0																																
	Side	C/D	3	2	1	0	0	0	0	0																																
Grey RAL7035	8100.8110.0																																									
Sandblasted	8100.8210.0																																									
EMC	8100.8210.4																																									
HE Black RAL 9005	8100.8310.1																																									

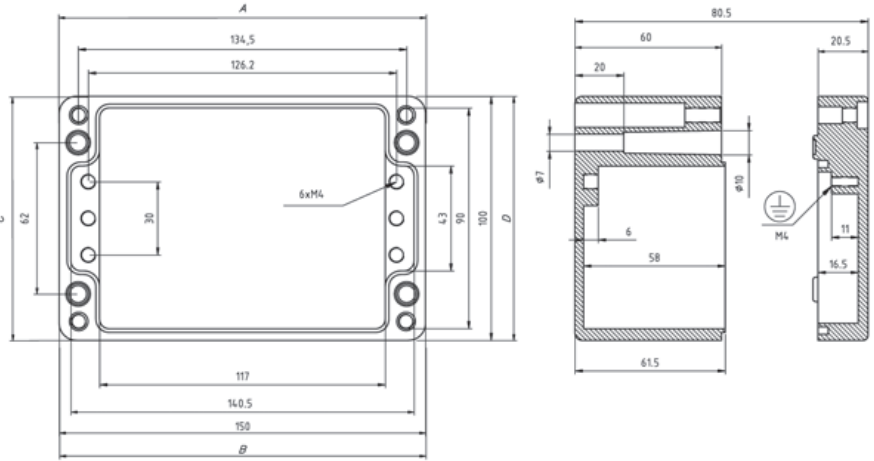
Model	18.08.06	Outside dimensions	175 x 80 x 57 mm	Color	Part No.																																									
 <p style="text-align: center;">Innenansicht Unterteil</p>		Grey RAL7001	8100.8011.0																																											
		Grey RAL7035	8100.8111.0																																											
		Sandblasted	8100.8211.0																																											
		EMC	8100.8211.4																																											
		HE Black RAL 9005	8100.8311.1																																											
<p>IP66 / IP69K</p> 																																														
<p>NEMA 250: Type 4,4x,12,13 Sandblasted enclosures Type 4,12,13</p>		<table border="1"> <thead> <tr> <th colspan="10">MAX M Thread</th> </tr> <tr> <th>M</th> <th>12</th> <th>16</th> <th>20</th> <th>25</th> <th>32</th> <th>40</th> <th>50</th> <th>63</th> <th></th> </tr> </thead> <tbody> <tr> <td>Side A/B</td> <td>14</td> <td>6</td> <td>4</td> <td>4</td> <td>0</td> <td>0</td> <td>0</td> <td>0</td> <td>0</td> </tr> <tr> <td>Side C/D</td> <td>4</td> <td>2</td> <td>1</td> <td>1</td> <td>0</td> <td>0</td> <td>0</td> <td>0</td> <td>0</td> </tr> </tbody> </table>			MAX M Thread										M	12	16	20	25	32	40	50	63		Side A/B	14	6	4	4	0	0	0	0	0	Side C/D	4	2	1	1	0	0	0	0	0		
MAX M Thread																																														
M	12	16	20	25	32	40	50	63																																						
Side A/B	14	6	4	4	0	0	0	0	0																																					
Side C/D	4	2	1	1	0	0	0	0	0																																					

Model	15.10.08	Outside dimensions	150 x 100 x 80 mm	Color	Part No.																																									
		Grey RAL7001	8100.8013.0																																											
		Grey RAL7035	8100.8113.0																																											
		Sandblasted	8100.8213.0																																											
		EMC	8100.8213.4																																											
		HE Black RAL 9005	8100.8313.1																																											
<p>IP66 / IP69K</p> 																																														
<p>NEMA 250: Type 4,4x,12,13 Sandblasted enclosures Type 4,12,13</p>		<table border="1"> <thead> <tr> <th colspan="10">MAX M Thread</th> </tr> <tr> <th>M</th> <th>12</th> <th>16</th> <th>20</th> <th>25</th> <th>32</th> <th>40</th> <th>50</th> <th>63</th> <th></th> </tr> </thead> <tbody> <tr> <td>Side A/B</td> <td>12</td> <td>6</td> <td>4</td> <td>2</td> <td>2</td> <td>0</td> <td>0</td> <td>0</td> <td>0</td> </tr> <tr> <td>Side C/D</td> <td>4</td> <td>2</td> <td>2</td> <td>1</td> <td>0</td> <td>0</td> <td>0</td> <td>0</td> <td>0</td> </tr> </tbody> </table>			MAX M Thread										M	12	16	20	25	32	40	50	63		Side A/B	12	6	4	2	2	0	0	0	0	Side C/D	4	2	2	1	0	0	0	0	0		
MAX M Thread																																														
M	12	16	20	25	32	40	50	63																																						
Side A/B	12	6	4	2	2	0	0	0	0																																					
Side C/D	4	2	2	1	0	0	0	0	0																																					

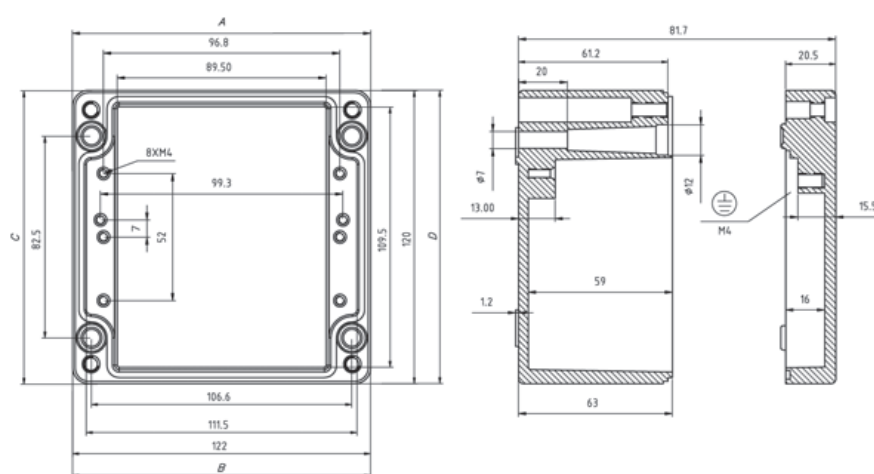
Model	12.12.08	Outside dimensions	122 x 120 x 80 mm	Color	Part No.																																					
 <p style="text-align: center;">IP66 / IP69K</p> <p style="text-align: center;">CE RoHS</p> <p>NEMA 250: Type 4,4x,12,13 Sandblasted enclosures Type 4,12,13</p> <table border="1"> <thead> <tr> <th colspan="10">MAX M Thread</th> </tr> <tr> <th>M</th> <th>12</th> <th>16</th> <th>20</th> <th>25</th> <th>32</th> <th>40</th> <th>50</th> <th>63</th> <th></th> </tr> </thead> <tbody> <tr> <td>Side A/B</td> <td>12</td> <td>6</td> <td>4</td> <td>2</td> <td>2</td> <td>0</td> <td>0</td> <td>0</td> <td></td> </tr> <tr> <td>Side C/D</td> <td>5</td> <td>2</td> <td>2</td> <td>1</td> <td>0</td> <td>0</td> <td>0</td> <td>0</td> <td></td> </tr> </tbody> </table>	MAX M Thread										M	12	16	20	25	32	40	50	63		Side A/B	12	6	4	2	2	0	0	0		Side C/D	5	2	2	1	0	0	0	0		Grey RAL7001	8100.8016.0
	MAX M Thread																																									
	M	12	16	20	25	32	40	50	63																																	
	Side A/B	12	6	4	2	2	0	0	0																																	
	Side C/D	5	2	2	1	0	0	0	0																																	
Grey RAL7035	8100.8116.0																																									
Sandblasted	8100.8216.0																																									
EMC	8100.8216.4																																									
HE Black RAL 9005	8100.8316.1																																									

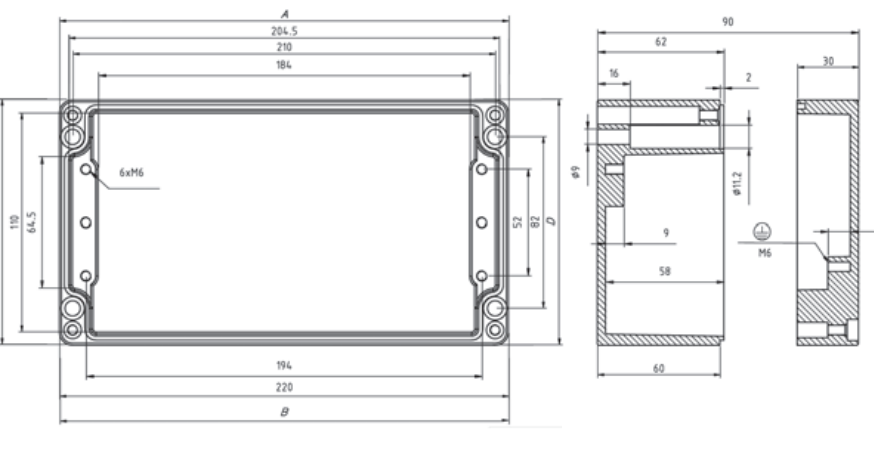
Model	22.12.09	Outside dimensions	220 x 120 x 90 mm	Color	Part No.																																					
 <p style="text-align: center;">IP66 / IP69K</p> <p style="text-align: center;">CE RoHS</p> <p>NEMA 250: Type 4,4x,12,13 Sandblasted enclosures Type 4,12,13</p> <table border="1"> <thead> <tr> <th colspan="10">MAX M Thread</th> </tr> <tr> <th>M</th> <th>12</th> <th>16</th> <th>20</th> <th>25</th> <th>32</th> <th>40</th> <th>50</th> <th>63</th> <th></th> </tr> </thead> <tbody> <tr> <td>Side A/B</td> <td>27</td> <td>12</td> <td>8</td> <td>5</td> <td>4</td> <td>0</td> <td>0</td> <td>0</td> <td></td> </tr> <tr> <td>Side C/D</td> <td>5</td> <td>2</td> <td>2</td> <td>1</td> <td>0</td> <td>0</td> <td>0</td> <td>0</td> <td></td> </tr> </tbody> </table>	MAX M Thread										M	12	16	20	25	32	40	50	63		Side A/B	27	12	8	5	4	0	0	0		Side C/D	5	2	2	1	0	0	0	0		Grey RAL7001	8100.8018.0
	MAX M Thread																																									
	M	12	16	20	25	32	40	50	63																																	
	Side A/B	27	12	8	5	4	0	0	0																																	
	Side C/D	5	2	2	1	0	0	0	0																																	
Grey RAL7035	8100.8118.0																																									
Sandblasted	8100.8218.0																																									
EMC	8100.8218.4																																									
HE Black RAL 9005	8100.8318.1																																									

Model	16.16.09	Outside dimensions	160 x 160 x 90 mm	Color	Part No.
-------	----------	--------------------	-------------------	-------	----------

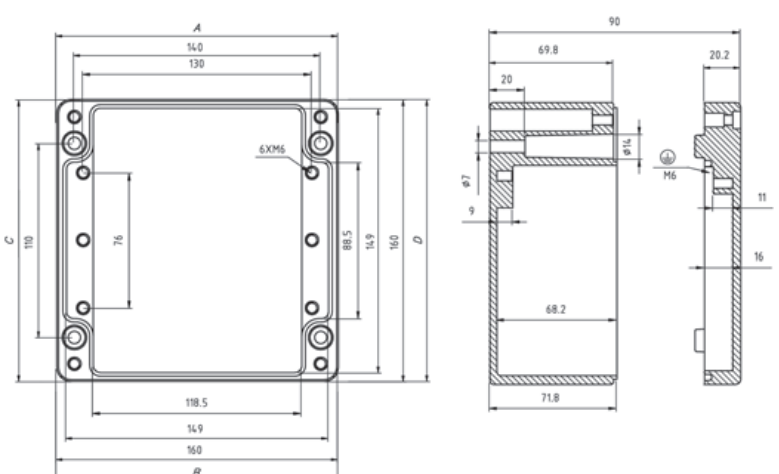

IP66 / IP69K



NEMA 250: Type 4,4x,12,13 Sandblasted enclosures Type 4,12,13

MAX M Thread										
M	12	16	20	25	32	40	50	63		
Side A/B	20	9	6	4	2	2	1	0		
Side C/D	8	4	3	2	2	0	0	0		

Grey RAL7001 8100.8019.0

Grey RAL7035 8100.8119.0

Sandblasted 8100.8219.0

EMC 8100.8219.4

HE Black RAL 9005 8100.8319.1

Model	24.16.10	Outside dimensions	240 x 160 x 100 mm	Color	Part No.
-------	----------	--------------------	--------------------	-------	----------

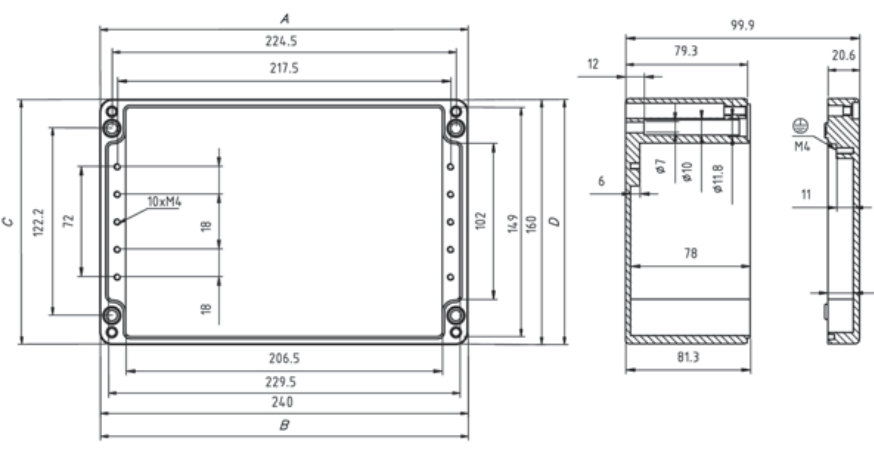

IP66 / IP69K



NEMA 250: Type 4,4x,12,13 Sandblasted enclosures Type 4,12,13

MAX M Thread										
M	12	16	20	25	32	40	50	63		
Side A/B	34	16	11	6	4	3	3	0		
Side C/D	8	4	3	2	2	0	0	0		

Grey RAL7001 8100.8021.0

Grey RAL7035 8100.8121.0

Sandblasted 8100.8221.0

EMC 8100.8221.4

HE Black RAL 9005 8100.8321.1

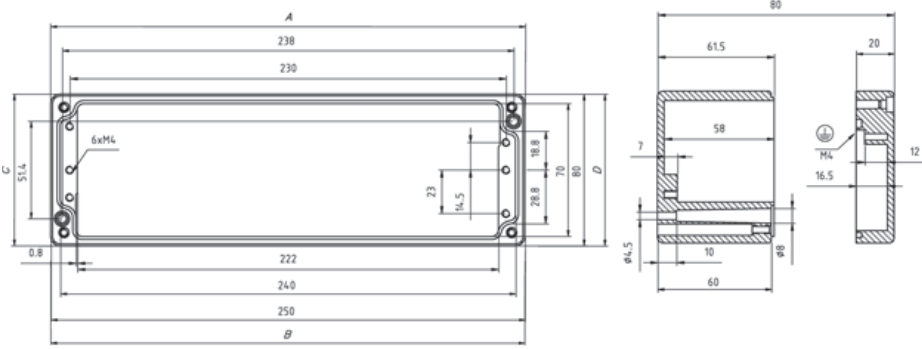
Model	25.08.08	Outside dimensions	250 x 80 x 80 mm	Color	Part No.																																					
 <p style="text-align: center;">IP66 / IP69K</p> <p style="text-align: right;">CE RoHS</p> <p>NEMA 250: Type 4,4x,12,13 Sandblasted enclosures Type 4,12,13</p> <table border="1"> <thead> <tr> <th colspan="10">MAX M Thread</th> </tr> <tr> <th>M</th> <th>12</th> <th>16</th> <th>20</th> <th>25</th> <th>32</th> <th>40</th> <th>50</th> <th>63</th> <th></th> </tr> </thead> <tbody> <tr> <td>Side A/B</td> <td>27</td> <td>12</td> <td>8</td> <td>5</td> <td>4</td> <td>0</td> <td>0</td> <td>0</td> <td></td> </tr> <tr> <td>Side C/D</td> <td>4</td> <td>2</td> <td>1</td> <td>1</td> <td>0</td> <td>0</td> <td>0</td> <td>0</td> <td></td> </tr> </tbody> </table>	MAX M Thread										M	12	16	20	25	32	40	50	63		Side A/B	27	12	8	5	4	0	0	0		Side C/D	4	2	1	1	0	0	0	0		Grey RAL7001	8100.8022.0
	MAX M Thread																																									
	M	12	16	20	25	32	40	50	63																																	
	Side A/B	27	12	8	5	4	0	0	0																																	
	Side C/D	4	2	1	1	0	0	0	0																																	
Grey RAL7035	8100.8122.0																																									
Sandblasted	8100.8222.0																																									
EMC	8100.8222.4																																									
HE Black RAL 9005	8100.8322.1																																									

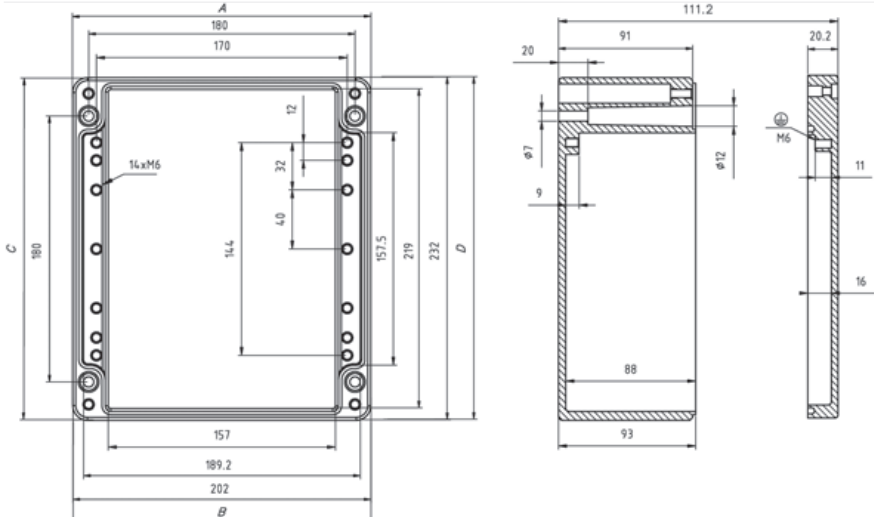
Model	20.23.11	Outside dimensions	200 x 230 x 110 mm	Color	Part No.																																					
 <p style="text-align: center;">IP66 / IP69K</p> <p style="text-align: right;">CE RoHS</p> <p>NEMA 250: Type 4,4x,12,13 Sandblasted enclosures Type 4,12,13</p> <table border="1"> <thead> <tr> <th colspan="10">MAX M Thread</th> </tr> <tr> <th>M</th> <th>12</th> <th>16</th> <th>20</th> <th>25</th> <th>32</th> <th>40</th> <th>50</th> <th>63</th> <th></th> </tr> </thead> <tbody> <tr> <td>Side A/B</td> <td>35</td> <td>15</td> <td>12</td> <td>8</td> <td>4</td> <td>3</td> <td>2</td> <td>2</td> <td></td> </tr> <tr> <td>Side C/D</td> <td>20</td> <td>12</td> <td>8</td> <td>5</td> <td>3</td> <td>2</td> <td>2</td> <td>1</td> <td></td> </tr> </tbody> </table>	MAX M Thread										M	12	16	20	25	32	40	50	63		Side A/B	35	15	12	8	4	3	2	2		Side C/D	20	12	8	5	3	2	2	1		Grey RAL7001	8100.8023.0
	MAX M Thread																																									
	M	12	16	20	25	32	40	50	63																																	
	Side A/B	35	15	12	8	4	3	2	2																																	
	Side C/D	20	12	8	5	3	2	2	1																																	
Grey RAL7035	8100.8123.0																																									
Sandblasted	8100.8223.0																																									
EMC	8100.8223.4																																									
HE Black RAL 9005	8100.8323.1																																									

Model	28.23.11	Outside dimensions	280 x 230 x 110 mm	Color	Part No.
-------	----------	--------------------	--------------------	-------	----------

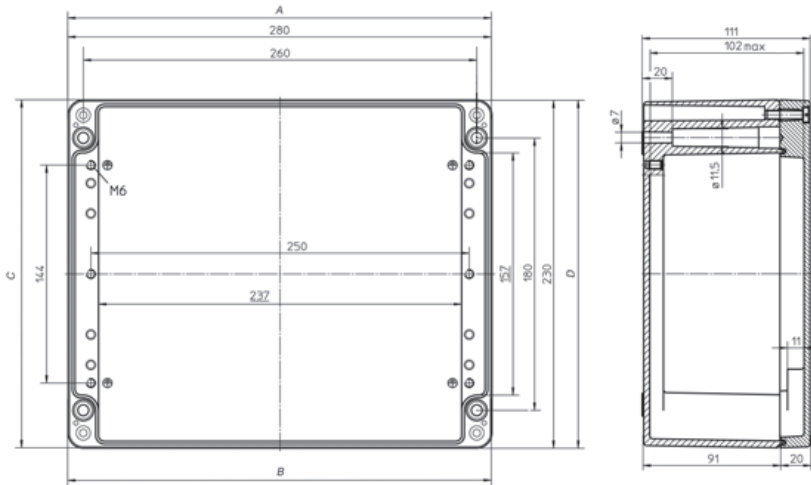

IP66 / IP69K



NEMA 250: Type 4,4x,12,13 Sandblasted enclosures Type 4,12,13

MAX M Thread									
M		12	16	20	25	32	40	50	63
Side	A/B	53	25	18	11	7	4	3	3
Side	C/D	26	12	8	5	3	2	2	1

- Grey RAL7001 8100.8024.0
- Grey RAL7035 8100.8124.0
- Sandblasted 8100.8224.0
- EMC 8100.8224.4
- HE Black RAL 9005 8100.8324.1

Model	36.16.09	Outside dimensions	360 x 160 x 90 mm	Color	Part No.
-------	----------	--------------------	-------------------	-------	----------

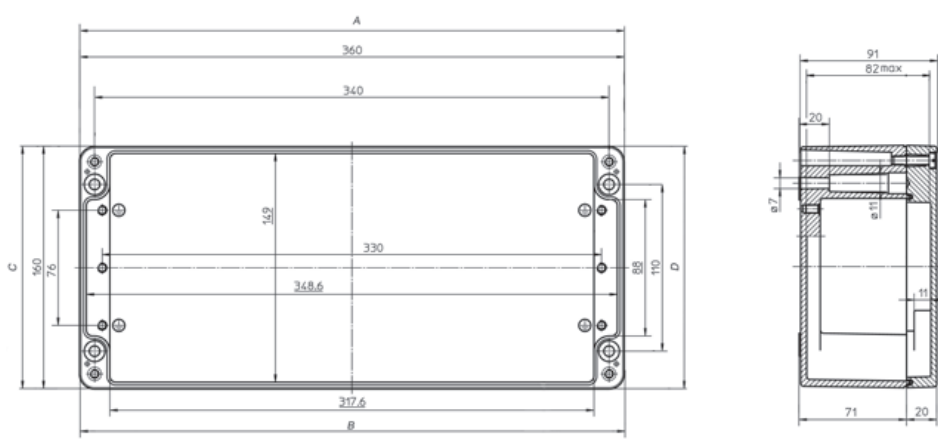

IP66 / IP69K



NEMA 250: Type 4,4x,12,13 Sandblasted enclosures Type 4,12,13

MAX M Thread									
M		12	16	20	25	32	40	50	63
Side	A/B	54	26	18	11	6	5	4	0
Side	C/D	8	4	3	2	2	0	0	0

- Grey RAL7001 8100.8025.0
- Grey RAL7035 8100.8125.0
- Sandblasted 8100.8225.0
- EMC 8100.8225.4
- HE Black RAL 9005 8100.8325.1

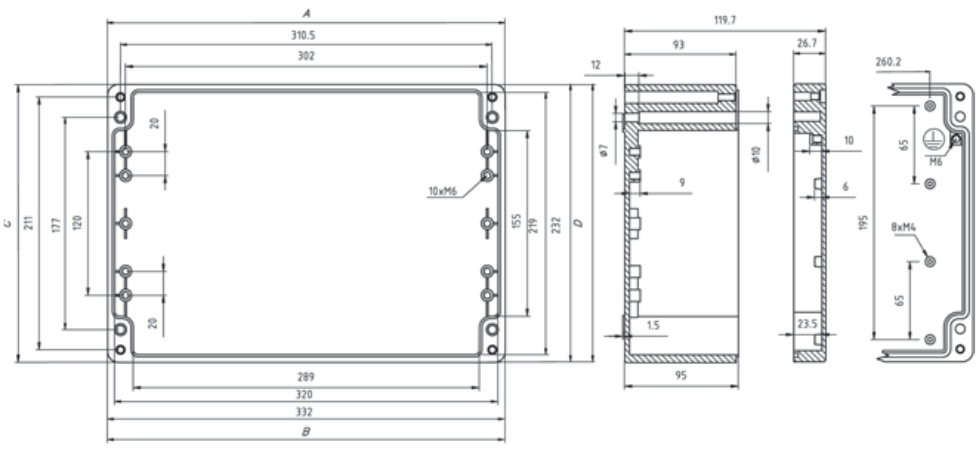
Model	33.23.12	Outside dimensions	330 x 230 x 120 mm	Color	Part No.																																					
 <p style="text-align: center;">IP66 / IP69K</p> <p style="text-align: right;">CE RoHS</p> <p>NEMA 250: Type 4,4x,12,13 Sandblasted enclosures Type 4,12,13</p> <table border="1"> <thead> <tr> <th colspan="10">MAX M Thread</th> </tr> <tr> <th>M</th> <th>12</th> <th>16</th> <th>20</th> <th>25</th> <th>32</th> <th>40</th> <th>50</th> <th>63</th> <th></th> </tr> </thead> <tbody> <tr> <td>Side A/B</td> <td>65</td> <td>30</td> <td>23</td> <td>12</td> <td>9</td> <td>5</td> <td>4</td> <td>3</td> <td></td> </tr> <tr> <td>Side C/D</td> <td>24</td> <td>11</td> <td>8</td> <td>5</td> <td>3</td> <td>2</td> <td>2</td> <td>1</td> <td></td> </tr> </tbody> </table>	MAX M Thread										M	12	16	20	25	32	40	50	63		Side A/B	65	30	23	12	9	5	4	3		Side C/D	24	11	8	5	3	2	2	1		Grey RAL7001	8100.8027.0
	MAX M Thread																																									
	M	12	16	20	25	32	40	50	63																																	
	Side A/B	65	30	23	12	9	5	4	3																																	
	Side C/D	24	11	8	5	3	2	2	1																																	
Grey RAL7035	8100.8127.0																																									
Sandblasted	8100.8227.0																																									
EMC	8100.8227.4																																									
HE Black RAL 9005	8100.8327.1																																									

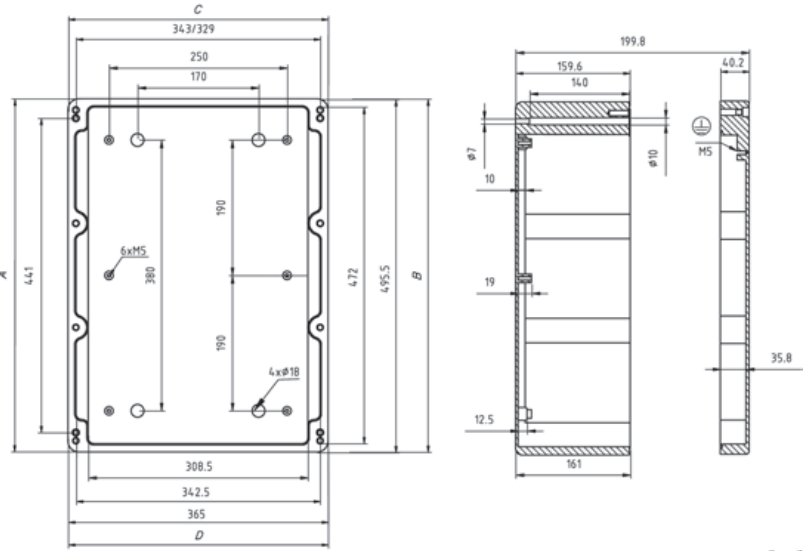
Model	50.36.20	Outside dimensions	496 x 365 x 200 mm	Color	Part No.																																					
 <p style="text-align: center;">IP66 / IP69K</p> <p style="text-align: right;">CE RoHS</p> <p>NEMA 250: Type 4,4x,12,13 Sandblasted enclosures Type 4,12,13</p> <table border="1"> <thead> <tr> <th colspan="10">MAX M Thread</th> </tr> <tr> <th>M</th> <th>12</th> <th>16</th> <th>20</th> <th>25</th> <th>32</th> <th>40</th> <th>50</th> <th>63</th> <th></th> </tr> </thead> <tbody> <tr> <td>Side A/B</td> <td>100</td> <td>42</td> <td>30</td> <td>19</td> <td>12</td> <td>7</td> <td>6</td> <td>5</td> <td></td> </tr> <tr> <td>Side C/D</td> <td>38</td> <td>21</td> <td>13</td> <td>7</td> <td>5</td> <td>4</td> <td>3</td> <td>2</td> <td></td> </tr> </tbody> </table>	MAX M Thread										M	12	16	20	25	32	40	50	63		Side A/B	100	42	30	19	12	7	6	5		Side C/D	38	21	13	7	5	4	3	2		Grey RAL7001	8100.8040.0
	MAX M Thread																																									
	M	12	16	20	25	32	40	50	63																																	
	Side A/B	100	42	30	19	12	7	6	5																																	
	Side C/D	38	21	13	7	5	4	3	2																																	
Grey RAL7035	8100.8140.0 On request																																									
Sandblasted	8100.8240.0 On request																																									
EMC	8100.8240.4 On request																																									
HE Black RAL 9005	8100.8340.1 On request																																									

Part No.	Page	Part No.	Page	Part No.	Page	Part No.	Page
2000.3001.0	39	5691.1836.X	59	7000.6874.0	49	7000.7123.2	44
2000.3002.0	39	5691.1844.X	59	7000.6874.3	49	7000.7124.2	44
2000.3003.0	39	5691.1851.X	59	7000.6875.0	49	7000.7125.2	44
2000.3004.0	39	5691.1869.X	59	7000.6875.3	49	7000.7127.2	44
2000.3005.0	39	5821.3372.0	49	7000.6876.0	49	7000.7128.2	44
2000.3006.0	39	5821.3380.0	49	7000.6876.3	49	7000.7129.2	44
2000.3007.0	39	5821.3455.0	49	7000.6881.0	49	7000.7130.2	44
2000.3008.0	39	5821.3463.0	49	7000.6882.0	49	7000.7131.2	44
2000.3013.0	39	5871.1854.X	49	7000.6886.0	49	7000.7132.2	44
2000.3020.0	39	5871.1896.X	49	7000.6896.0	42	7000.7310.0	45
2000.3021.0	39	5871.1904.X	49	7000.6896.3	42	7000.7311.0	45
2000.3022.0	39	5871.1938.X	49	7000.6897.0	42	7000.7312.0	45
2000.3023.0	39	5871.1961.X	49	7000.6897.3	42	7000.7313.0	45
2000.3024.0	39	5871.1987.X	49	7000.6898.3	42	7000.7314.0	45
2000.3025.0	39	5871.1995.X	49	7000.6899.3	42	7000.7315.0	45
2000.3027.0	39	6121.0008.0	49	7000.6900.3	42	7000.7316.0	45
2000.3029.0	39	6341.0021.0	49	7000.6901.3	42	7000.7317.0	45
2000.3031.0	39	6341.0120.A	49	7000.6928.0	45	7000.7320.0	45
2000.3033.0	39	6341.0138.X	49	7000.6929.0	45	7000.7321.0	45
2000.3035.0	39	6341.0139.X	49	7000.6930.0	45	7000.7322.0	45
2000.3036.0	39	6341.1425.X	49	7000.6931.0	45	7000.7323.0	45
2000.3100.0	39	6341.1938.A	49	7000.6932.0	45	7000.7324.0	45
2000.3105.0	39	6341.2092.A	49	7000.6933.0	45	7000.7325.0	45
2000.3110.0	39	6341.2241.A	49	7000.6934.0	45	7000.7326.0	45
2000.3115.0	39	6341.4411.0	49	7000.6935.0	45	7000.7327.0	45
2000.3120.0	39	7000.6788.0	45	7000.6936.0	45	7000.7328.0	45
2000.3140.0	39	7000.6789.0	45	7000.6937.0	45	7000.7329.0	45
2000.3145.0	39	7000.6791.0	45	7000.6942.0	45	7000.7360.0	46
2000.3170.0	39	7000.6792.0	45	7000.6943.0	45	7000.7361.0	46
2000.3170.A	39	7000.6793.0	45	7000.6944.0	45	7000.7370.0	46
2000.3175.0	39	7000.6794.0	45	7000.6945.0	45	7000.7371.0	46
2000.3180.0	39	7000.6796.0	45	7000.6946.0	45	7000.7380.0	46
2000.3180.A	39	7000.6797.0	45	7000.6947.0	45	7000.7381.0	46
2100.3150.0	39	7000.6798.0	45	7000.6948.0	45	7000.7701.0	42
2100.3150.2	39	7000.6799.0	45	7000.6949.0	45	7000.7702.0	42
2100.3150.3	39	7000.6825.0	42	7000.6950.0	44	7000.7703.0	42
2100.3150.5	39	7000.6825.3	42	7000.6951.0	44	7000.7704.0	42
2100.3310.1	41	7000.6826.0	42	7000.6952.0	44	7000.7705.0	42
2100.3310.6	41	7000.6826.3	42	7000.6953.0	44	7000.7706.0	42
2100.3312.1	41	7000.6827.0	42	7000.6954.0	44	7000.7707.0	42
2100.3312.6	41	7000.6827.3	42	7000.6955.0	44	7000.7708.0	42
2100.3316.1	41	7000.6828.0	42	7000.6956.0	44	7000.7709.0	42
2100.3320.0	41	7000.6828.3	42	7000.6957.0	44	7000.7710.0	42
2100.3320.6	41	7000.6829.0	42	7000.6958.0	44	7000.7711.0	42
2100.3322.0	41	7000.6829.3	42	7000.6959.0	44	7000.7712.0	42
2100.3322.5	41	7000.6830.0	42	7000.6960.0	44	7000.7713.0	42
2100.3324.0	41	7000.6830.3	42	7000.6961.0	44	7000.7714.0	42
2100.3401.2	39	7000.6831.0	42	7000.6962.0	44	7000.7715.0	42
2100.3401.3	39	7000.6831.3	42	7000.6963.0	44	7000.7716.0	42
2100.3401.5	39	7000.6832.0	42	7000.6964.0	44	7000.7717.0	42
2100.3502.0	41	7000.6832.3	42	7000.6965.0	44	7000.7721.0	42
2100.3502.1	41	7000.6833.0	42	7000.6966.0	44	7000.7722.0	42
2100.3502.2	41	7000.6833.3	42	7000.6967.0	44	7000.7723.0	42
2100.3502.3	41	7000.6834.0	42	7000.6971.0	45	7000.7724.0	42
2100.3502.5	41	7000.6834.3	42	7000.6972.0	45	7000.7725.0	42
2100.3525.0	41	7000.6835.0	42	7000.6975.0	45	7000.7726.0	42
2110.3210.0	41	7000.6835.3	42	7000.6976.0	45	7000.7727.0	42
2110.3212.0	41	7000.6836.3	42	7000.6977.0	45	7000.7728.0	42
2110.3214.0	41	7000.6837.0	42	7000.6978.0	45	7000.7729.0	42
2110.3216.0	41	7000.6837.1	42	7000.6979.0	45	7000.7730.0	42
2110.3220.0	41	7000.6839.0	42	7000.6980.0	45	7000.7731.0	42
2110.3222.0	41	7000.6839.1	42	7000.6981.0	45	7000.7732.0	42
2110.3224.0	41	7000.6841.0	42	7000.6982.0	45	7000.7733.0	42
2110.3226.0	41	7000.6842.0	42	7000.6983.0	45	7000.7734.0	42
5121.019X.X	49	7000.6843.0	42	7000.6984.0	45	7000.7735.0	42
5121.021X.X	49	7000.6844.0	42	7000.6985.0	45	7000.7736.0	42
5121.033X.X	49	7000.6845.0	42	7000.6986.0	45	7000.7737.0	42
5121.102X.X	49	7000.6846.0	42	7000.7000.0	48	7000.7771.0	45
5121.1031.X	49	7000.6847.0	42	7000.7050.0	47	7000.7772.0	45
5121.103X.X	49	7000.6848.0	42	7000.7051.0	47	7000.7775.0	45
5121.120X.X	49	7000.6849.0	42	7000.7052.0	47	7000.7780.0	45
5121.167X.X	49	7000.6850.0	42	7000.7053.0	47	7000.7781.0	45
5121.2135.X	49	7000.6851.0	42	7000.7054.0	47	7000.7783.0	45
5121.2171.X	49	7000.6852.0	42	7000.7055.0	47	7000.7784.0	45
5131.0514.X	49	7000.6865.0	45	7000.7056.0	47	7000.7785.0	45
5131.0587.X	49	7000.6866.0	45	7000.7060.0	47	7000.7786.0	45
5341.1039.X	49	7000.6867.0	45	7000.7061.0	47	7000.7791.0	45
5341.2920.0	49	7000.6868.0	45	7000.7062.0	47	7000.7792.0	45
5341.3340.0	49	7000.6869.0	45	7000.7063.0	47	7000.7793.0	45
5341.3860.0	49	7000.6870.0	45	7000.7065.0	47	7000.7794.0	45
5341.4124.X	49	7000.6871.0	45	7000.7066.0	47	7000.7795.0	45
5631.3836.X	59	7000.6872.0	45	7000.7067.0	47	7000.7796.0	45
5631.3869.X	59	7000.6873.0	45	7000.7122.2	44	7000.7797.0	45

Part No.	-	Page	Part No.	-	Page	Part No.	-	Page	Part No.	-	Page
7000.7798.0		45	7000.7834.1		43	7001.8001.9		50	7001.8185.8		51
7000.7799.0		45	7000.7834.2		43	7001.8002.9		50	7001.8188.4		51
7000.7800.0		45	7000.7834.5		43	7001.8003.9		50	7001.8191.2		51
7000.7801.0		45	7000.7834.6		43	7001.8011.3		50	7001.8194.6		51
7000.7821.0		43	7000.7834.7		43	7001.8011.9		50	7006.7000.0		48
7000.7821.1		43	7000.7835.0		43	7001.8012.3		50	7006.7009.0		48
7000.7821.2		43	7000.7835.1		43	7001.8012.9		50	7010.7000.0		48
7000.7821.5		43	7000.7835.2		43	7001.8013.9		50	7010.7009.0		48
7000.7821.6		43	7000.7835.5		43	7001.8021.8		50	7016.7000.0		48
7000.7821.7		43	7000.7835.6		43	7001.8021.9		50	7016.7009.0		48
7000.7822.0		43	7000.7835.7		43	7001.8022.6		50	7024.7000.0		48
7000.7822.1		43	7000.7836.0		43	7001.8022.8		50	7024.7009.0		48
7000.7822.2		43	7000.7836.1		43	7001.8022.9		50	7100.4031.0		19
7000.7822.5		43	7000.7836.2		43	7001.8023.8		50	7100.4031.1		19
7000.7822.6		43	7000.7836.5		43	7001.8024.8		50	7100.4031.2		19
7000.7822.7		43	7000.7836.6		43	7001.8024.9		50	7100.4032.0		19
7000.7823.0		43	7000.7836.7		43	7001.8031.2		50	7100.4032.1		19
7000.7823.1		43	7000.7837.0		43	7001.8031.4		50	7100.4032.2		19
7000.7823.2		43	7000.7837.1		43	7001.8032.2		50	7100.4033.0		19
7000.7823.5		43	7000.7837.2		43	7001.8032.4		50	7100.4033.1		19
7000.7823.6		43	7000.7837.5		43	7001.8033.2		50	7100.4033.2		19
7000.7823.7		43	7000.7837.6		43	7001.8034.2		50	7100.4037.0		19
7000.7824.0		43	7000.7837.7		43	7001.8034.4		50	7100.4037.1		19
7000.7824.1		43	7000.7838.0		43	7001.8041.0		50	7100.4037.2		19
7000.7824.2		43	7000.7838.1		43	7001.8041.2		50	7100.4038.0		19
7000.7824.5		43	7000.7838.2		43	7001.8042.0		50	7100.4038.1		19
7000.7824.6		43	7000.7838.5		43	7001.8042.2		50	7100.4038.2		19
7000.7824.7		43	7000.7838.6		43	7001.8043.0		50	7100.4039.0		19
7000.7825.0		43	7000.7838.7		43	7001.8044.0		50	7100.4039.1		19
7000.7825.1		43	7000.7841.0		44	7001.8044.2		50	7100.4039.2		19
7000.7825.2		43	7000.7841.1		44	7001.8051.6		50	7100.4071.0		19
7000.7825.5		43	7000.7841.2		44	7001.8051.8		50	7100.4071.1		19
7000.7825.6		43	7000.7842.0		44	7001.8052.6		50	7100.4071.2		19
7000.7825.7		43	7000.7842.1		44	7001.8052.8		50	7100.4072.0		19
7000.7826.0		43	7000.7842.2		44	7001.8053.6		50	7100.4072.1		19
7000.7826.1		43	7000.7843.0		44	7001.8053.8		50	7100.4072.2		19
7000.7826.2		43	7000.7843.1		44	7001.8061.3		50	7100.4073.0		19
7000.7826.5		43	7000.7843.2		44	7001.8061.8		50	7100.4073.1		19
7000.7826.6		43	7000.7844.0		44	7001.8062.3		50	7100.4073.2		19
7000.7826.7		43	7000.7844.1		44	7001.8062.8		50	7100.4077.0		19
7000.7827.0		43	7000.7844.2		44	7001.8063.3		50	7100.4077.1		19
7000.7827.1		43	7000.7845.0		44	7001.8063.8		50	7100.4077.2		19
7000.7827.2		43	7000.7845.1		44	7001.8071.0		50	7100.4078.0		19
7000.7827.5		43	7000.7845.2		44	7001.8071.4		50	7100.4078.1		19
7000.7827.6		43	7000.7846.0		44	7001.8071.5		50	7100.4078.2		19
7000.7827.7		43	7000.7846.1		44	7001.8072.0		50	7100.4079.0		19
7000.7828.0		43	7000.7846.2		44	7001.8072.4		50	7100.4079.1		19
7000.7828.1		43	7000.7847.0		44	7001.8072.5		50	7100.4079.2		19
7000.7828.2		43	7000.7847.1		44	7001.8081.1		51	7100.4201.0		18
7000.7828.5		43	7000.7847.2		44	7001.8081.2		51	7100.4201.1		18
7000.7828.6		43	7000.7848.0		44	7001.8081.9		51	7100.4202.0		18
7000.7828.7		43	7000.7848.1		44	7001.8082.1		51	7100.4202.1		18
7000.7829.0		43	7000.7848.2		44	7001.8082.2		51	7100.4203.0		18
7000.7829.1		43	7000.7849.0		44	7001.8082.9		51	7100.4203.1		18
7000.7829.2		43	7000.7849.1		44	7001.8091.5		51	7100.4204.0		18
7000.7829.5		43	7000.7849.2		44	7001.8091.6		51	7100.4204.1		18
7000.7829.6		43	7000.7850.0		44	7001.8091.9		51	7100.4205.0		18
7000.7829.7		43	7000.7850.1		44	7001.8092.5		51	7100.4205.1		18
7000.7830.0		43	7000.7850.2		44	7001.8092.6		51	7100.4206.0		18
7000.7830.1		43	7000.7851.0		44	7001.8092.9		51	7100.4206.1		18
7000.7830.2		43	7000.7851.1		44	7001.8101.0		51	7100.4211.0		18
7000.7830.5		43	7000.7851.2		44	7001.8101.1		51	7100.4211.1		18
7000.7830.6		43	7000.7852.0		44	7001.8101.4		51	7100.4212.0		18
7000.7830.7		43	7000.7852.1		44	7001.8102.0		51	7100.4212.1		18
7000.7831.0		43	7000.7852.2		44	7001.8102.1		51	7100.4213.0		18
7000.7831.1		43	7000.7853.0		44	7001.8102.4		51	7100.4213.1		18
7000.7831.2		43	7000.7853.1		44	7001.8111.2		51	7100.4214.0		18
7000.7831.5		43	7000.7853.2		44	7001.8111.9		51	7100.4214.1		18
7000.7831.6		43	7000.7854.0		44	7001.8112.2		51	7100.4215.0		18
7000.7831.7		43	7000.7854.1		44	7001.8112.9		51	7100.4215.1		18
7000.7832.0		43	7000.7854.2		44	7001.8121.5		51	7100.4216.0		18
7000.7832.1		43	7000.7855.0		44	7001.8121.6		51	7100.4216.1		18
7000.7832.2		43	7000.7855.1		44	7001.8122.5		51	7107.4001.0		15
7000.7832.5		43	7000.7855.2		44	7001.8122.6		51	7107.4001.1		15
7000.7832.6		43	7000.7856.0		44	7001.8150.9		51	7107.4101.0		15
7000.7832.7		43	7000.7856.1		44	7001.8151.8		51	7107.4101.1		15
7000.7833.0		43	7000.7856.2		44	7001.8152.8		51	7108.4002.0		15
7000.7833.1		43	7000.7857.0		44	7001.8161.2		51	7108.4058.0		15
7000.7833.2		43	7000.7857.1		44	7001.8162.2		51	7108.4059.0		15
7000.7833.5		43	7000.7857.2		44	7001.8171.0		51	7108.4102.0		15
7000.7833.6		43	7000.7858.0		44	7001.8172.0		51	7108.4158.0		15
7000.7833.7		43	7000.7858.1		44	7001.8181.6		51	7108.4159.0		15
7000.7834.0		43	7000.7858.2		44	7001.8182.6		51	7115.4006.0		15

Part No.	-	Page	Part No.	-	Page	Part No.	-	Page	Part No.	-	Page
7115.4106.0		15	7306.6145.0		16	7506.5932.0		14	7803.6803.0		21
7124.4040.0		15	7306.6161.0		11	7506.5934.0		14	7803.6803.1		21
7124.4140.0		15	7310.5852.0		11	7506.6032.0		13	7803.6804.0		21
7125.4012.0		15	7310.5862.0		17	7506.6052.0		13	7806.5212.0		31
7125.4012.3		15	7310.5952.0		11	7506.6072.0		13-14	7806.5214.0		31
7125.4112.0		15	7310.5962.0		17	7506.6082.0		14	7806.5216.0		31
7125.4112.3		15	7310.6004.0		10	7506.6132.0		13	7806.5218.0		31
7140.4018.0		15	7310.6062.0		11	7506.6152.0		13	7806.5220.0		31
7140.4118.0		15	7310.6090.0		12	7506.6172.0		13-14	7806.5270.0		31
7142.4046.0		15	7310.6104.0		10	7506.6182.0		14	7806.5280.0		31
7142.4146.0		15	7310.6162.0		11	7510.5833.0		14	7806.5280.5		31
7164.4024.0		15	7310.6190.0		12	7510.5835.0		14	7806.5281.0		31
7164.4124.0		15	7312.6043.0		16	7510.5933.0		14	7806.5281.5		31
7172.4052.0		15	7312.6143.0		16	7510.5935.0		14	7806.5282.0		31
7172.4053.0		15	7316.5853.0		11-12	7510.6033.0		13	7806.5282.5		31
7172.4152.0		15	7316.5854.0		12	7510.6053.0		13	7806.5283.0		31
7172.4153.0		15	7316.5863.0		17	7510.6073.0		13-14	7806.5283.5		31
7203.6001.0		10	7316.5864.0		17	7510.6083.0		14	7806.5299.0		31
7203.6001.1		10	7316.5953.0		11-12	7510.6133.0		13	7806.5299.5		31
7203.6101.0		10	7316.5954.0		12	7510.6153.0		13	7806.5300.0		31
7203.6101.1		10	7316.5963.0		17	7510.6173.0		13-14	7806.5300.5		31
7204.6002.0		10	7316.5964.0		17	7510.6183.0		14	7806.5301.0		31
7204.6002.1		10	7316.6005.0		10-11	7516.6034.0		13	7806.5301.5		31
7204.6102.0		10	7316.6006.0		11	7516.6035.0		13	7806.5302.0		31
7204.6102.1		10	7316.6063.0		11	7516.6134.0		13	7806.5302.5		31
7210.4401.0		10	7316.6064.0		11	7516.6135.0		13	7806.5303.0		31
7210.4411.0		10	7316.6105.0		10-11	7600.5700.0		18	7806.5303.5		31
7210.4451.0		10	7316.6106.0		11	7600.5701.0		18	7806.6301.0		26
7210.4461.0		10	7316.6163.0		11	7600.5702.0		18	7806.6302.0		26
7216.4402.0		10	7316.6164.0		11	7600.5703.0		18	7806.6311.0		26
7216.4403.0		10	7318.6091.0		12	7600.5710.0		18	7806.6312.0		26
7216.4412.0		10	7318.6191.0		12	7600.5711.0		18	7806.6343.0		30
7216.4413.0		10	7324.5855.0		11-12	7600.5712.0		18	7806.6344.0		30
7216.4452.0		10	7324.5856.0		12	7600.5713.0		18	7806.6351.0		26
7216.4453.0		10	7324.5865.0		17	7605.5801.0		16	7806.6352.0		26
7216.4462.0		10	7324.5866.0		17	7605.5901.0		16	7806.6361.0		26
7216.4463.0		10	7324.5955.0		11-12	7606.5815.0		16	7806.6362.0		26
7300.6235.0		18	7324.5956.0		12	7606.5915.0		16	7806.6391.0		30
7300.6235.1		18	7324.5965.0		17	7608.5807.0		16	7806.6392.0		30
7300.6236.0		18	7324.5966.0		17	7608.5907.0		16	7806.6395.0		30
7300.6236.1		18	7324.6007.0		10-11	7612.5805.0		16	7806.6396.0		30
7300.6237.0		18	7324.6008.0		11	7612.5905.0		16	7806.6401.0		28
7300.6237.1		18	7324.6065.0		11	7617.5811.0		16	7806.6402.0		28
7300.6238.0		18	7324.6066.0		11	7617.5911.0		16	7806.6427.0		28
7300.6238.1		18	7324.6107.0		10-11	7803.6201.0		21	7806.6427.5		28
7300.6239.0		18	7324.6108.0		11	7803.6201.1		21	7806.6428.0		28
7300.6239.1		18	7324.6165.0		11	7803.6202.0		21	7806.6428.5		28
7300.6240.0		18	7324.6166.0		11	7803.6202.A		21	7806.6449.0		28
7300.6240.1		18	7332.6092.0		12	7803.6203.0		21	7806.6449.5		28
7300.6241.0		18	7332.6093.0		12	7803.6203.1		21	7806.6450.0		28
7300.6241.1		18	7332.6192.0		12	7803.6204.0		21	7806.6450.5		28
7300.6242.0		18	7332.6193.0		12	7803.6204.A		21	7806.6477.0		29
7300.6242.1		18	7346.6094.0		12	7803.6205.0		21	7806.6477.5		29
7300.6243.0		18	7346.6095.0		12	7803.6205.1		21	7806.6478.0		29
7300.6243.1		18	7346.6194.0		12	7803.6206.0		21	7806.6478.5		29
7300.6244.0		18	7346.6195.0		12	7803.6206.A		21	7806.6491.0		29
7300.6244.1		18	7400.6836.0		49	7803.6207.0		21	7806.6491.5		29
7300.6245.0		18	7400.6877.0		49	7803.6207.1		21	7806.6492.0		29
7300.6245.1		18	7400.6878.0		49	7803.6208.0		21	7806.6492.5		29
7300.6246.0		18	7406.6011.0		12	7803.6209.0		21	7806.6501.0		28
7300.6246.1		18	7406.6012.0		12	7803.6209.1		21	7806.6502.0		28
7300.6247.0		18	7406.6111.0		12	7803.6210.0		21	7806.6503.0		28
7300.6247.1		18	7406.6112.0		12	7803.6211.0		21	7806.6504.0		28
7300.6248.0		18	7410.6013.0		12	7803.6211.1		21	7806.6531.0		29
7300.6248.1		18	7410.6014.0		12	7803.6212.0		21	7806.6542.0		29
7300.6249.0		18	7410.6113.0		12	7803.6212.A		21	7806.6551.0		28
7300.6249.1		18	7410.6114.0		12	7803.6225.0		21	7806.6552.0		28
7300.6250.0		18	7416.6015.0		13	7803.6225.1		21	7806.6553.0		28
7300.6250.1		18	7416.6016.0		13	7803.6226.0		21	7806.6554.0		28
7304.6044.0		16	7416.6115.0		13	7803.6226.A		21	7806.6581.0		29
7304.6144.0		16	7416.6116.0		13	7803.6227.0		21	7806.6592.0		29
7306.5851.0		11	7424.6017.0		13	7803.6227.1		21	7806.6813.0		30
7306.5861.0		17	7424.6018.0		13	7803.6228.0		21	7806.6818.0		30
7306.5951.0		11	7424.6117.0		13	7803.6229.0		21	7806.6941.0		28
7306.5961.0		17	7424.6118.0		13	7803.6229.1		21	7806.6991.0		30
7306.6003.0		10	7503.5831.0		14	7803.6230.0		21	7806.7001.0		30
7306.6041.0		14	7503.5931.0		14	7803.6231.0		21	7806.7002.0		30
7306.6042.0		14	7503.6031.0		13	7803.6231.1		21	7806.7101.0		30
7306.6045.0		16	7503.6071.0		13	7803.6232.0		21	7806.7102.0		30
7306.6061.0		11	7503.6131.0		13	7803.6232.A		21	7806.7150.0		26
7306.6103.0		10	7503.6171.0		13	7803.6801.0		21	7806.7151.0		26
7306.6141.0		14	7506.5832.0		14	7803.6801.1		21	7806.7152.0		26
7306.6142.0		14	7506.5834.0		14	7803.6802.0		21	7806.7153.0		26

Part No.	-	Page	Part No.	-	Page	Part No.	-	Page	Part No.	-	Page
7806.7154.0		26	7810.4581.0		24	7810.5307.5		31	7810.7008.5		29
7806.7155.0		26	7810.4581.5		24	7810.5308.0		31	7810.7009.0		29
7806.7156.0		26	7810.4582.0		24	7810.5308.5		31	7810.7009.5		29
7806.7157.0		26	7810.4582.5		24	7810.5361.0		34	7810.7011.0		33
7806.7158.0		26	7810.4583.0		24	7810.5362.0		34	7810.7012.0		33
7806.7205.0		28	7810.4583.5		24	7810.6303.0		26	7810.7104.0		34
7806.7211.0		27	7810.4584.0		24	7810.6304.0		26	7810.7104.5		34
7806.7212.0		27	7810.4584.5		24	7810.6313.0		26	7810.7105.0		34
7806.7220.0		27	7810.4591.0		23	7810.6314.0		26	7810.7105.5		34
7806.7221.0		27	7810.4594.0		23	7810.6322.0		32	7810.7107.0		29
7806.7222.0		27	7810.4992.0		23	7810.6323.0		32	7810.7107.5		29
7806.7223.0		27	7810.4993.0		23	7810.6353.0		26	7810.7108.0		29
7806.7224.0		27	7810.5001.0		35	7810.6354.0		26	7810.7108.5		29
7806.7225.0		27	7810.5002.0		35	7810.6363.0		26	7810.7109.0		33
7806.7226.0		27	7810.5003.0		35	7810.6364.0		26	7810.7159.0		26
7806.7227.0		27	7810.5004.0		35	7810.6372.0		32	7810.7160.0		26
7806.7228.0		27	7810.5023.0		35	7810.6373.0		32	7810.7161.0		26
7806.7251.0		27	7810.5024.0		35	7810.6403.0		28	7810.7162.0		26
7806.7252.0		27	7810.5025.0		35	7810.6404.0		28	7810.7163.0		26
7806.7264.0		26	7810.5026.0		35	7810.6412.0		32	7810.7164.0		26
7806.7265.0		26	7810.5050.0		36	7810.6421.0		33	7810.7165.0		26
7806.7266.0		26	7810.5054.0		36	7810.6421.5		33	7810.7166.0		26
7806.7267.0		26	7810.5060.0		36	7810.6422.0		33	7810.7167.0		26
7806.7268.0		26	7810.5061.0		36	7810.6422.5		33	7810.7206.0		28
7806.7269.0		26	7810.5062.0		36	7810.6429.0		28	7810.7213.0		27
7806.7270.0		26	7810.5070.0		37	7810.6429.5		28	7810.7214.0		27
7806.7271.0		26	7810.5070.5		37	7810.6430.0		28	7810.7229.0		27
7806.7272.0		26	7810.5071.0		37	7810.6430.5		28	7810.7230.0		27
7806.7450.0		30	7810.5071.5		37	7810.6443.0		33	7810.7231.0		27
7806.7451.0		30	7810.5072.0		37	7810.6443.5		33	7810.7232.0		27
7806.7452.0		30	7810.5072.5		37	7810.6444.0		33	7810.7233.0		27
7806.7453.0		30	7810.5073.0		37	7810.6444.5		33	7810.7234.0		27
7806.7550.0		30	7810.5073.5		37	7810.6451.0		28	7810.7235.0		27
7806.7551.0		30	7810.5090.0		37	7810.6451.5		28	7810.7236.0		27
7806.7552.0		30	7810.5091.0		37	7810.6452.0		28	7810.7237.0		27
7806.7553.0		30	7810.5092.0		37	7810.6452.5		28	7810.7253.0		27
7808.6650.6		22	7810.5100.0		37	7810.6471.0		33	7810.7254.0		27
7808.6651.6		22	7810.5100.5		37	7810.6471.5		33	7810.7273.0		26
7808.6654.6		22	7810.5101.0		37	7810.6472.0		33	7810.7274.0		26
7808.6655.6		22	7810.5101.5		37	7810.6472.5		33	7810.7275.0		26
7808.6660.1		22	7810.5102.0		37	7810.6479.0		29	7810.7276.0		26
7808.6662.1		22	7810.5102.5		37	7810.6479.5		29	7810.7277.0		26
7808.6663.1		22	7810.5103.0		37	7810.6480.0		29	7810.7278.0		26
7808.6664.1		22	7810.5103.5		37	7810.6480.5		29	7810.7279.0		26
7808.6665.1		22	7810.5120.0		37	7810.6485.0		33	7810.7280.0		26
7808.6666.1		22	7810.5124.0		37	7810.6485.5		33	7810.7281.0		26
7808.6669.1		22	7810.5129.0		36	7810.6486.0		33	7810.7458.0		32
7810.4490.0		23	7810.5130.0		36	7810.6486.5		33	7810.7459.0		32
7810.4491.0		23	7810.5131.0		36	7810.6493.0		29	7810.7460.0		32
7810.4501.0		23	7810.5132.0		36	7810.6493.5		29	7810.7461.0		32
7810.4502.0		23	7810.5133.0		36	7810.6494.0		29	7810.7462.0		32
7810.4503.0		23	7810.5134.0		36	7810.6494.5		29	7810.7463.0		32
7810.4504.0		23	7810.5135.0		36	7810.6505.0		28	7810.7464.0		32
7810.4505.0		23	7810.5136.0		36	7810.6506.0		28	7810.7465.0		32
7810.4506.0		23	7810.5137.0		36	7810.6519.0		33	7810.7466.0		32
7810.4507.0		23	7810.5159.0		36	7810.6520.0		33	7810.7467.0		32
7810.4508.0		23	7810.5160.0		36	7810.6532.0		29	7810.7562.0		32
7810.4511.0		23	7810.5161.0		36	7810.6536.0		35	7810.7563.0		32
7810.4512.0		23	7810.5162.0		36	7810.6555.0		28	7810.7573.0		32
7810.4513.0		23	7810.5163.0		36	7810.6556.0		28	7810.7574.0		32
7810.4514.0		23	7810.5164.0		36	7810.6569.0		33	7816.4521.0		23
7810.4515.0		23	7810.5165.0		36	7810.6570.0		33	7816.4522.0		23
7810.4516.0		23	7810.5166.0		36	7810.6582.0		29	7816.4523.0		23
7810.4517.0		23	7810.5167.0		36	7810.6586.0		35	7816.4524.0		23
7810.4518.0		23	7810.5222.0		31	7810.6593.0		28	7816.4525.0		23
7810.4541.0		23	7810.5224.0		31	7810.6594.0		28	7816.4526.0		23
7810.4542.0		23	7810.5226.0		31	7810.6595.0		33	7816.4527.0		23
7810.4550.0		23	7810.5228.0		31	7810.6596.0		33	7816.4528.0		23
7810.4551.0		23	7810.5230.0		31	7810.6598.0		35	7816.4531.0		23
7810.4552.0		23	7810.5271.0		31	7810.6610.0		34	7816.4532.0		23
7810.4553.0		23	7810.5285.0		31	7810.6610.5		34	7816.4533.0		23
7810.4561.0		23	7810.5285.5		31	7810.6612.0		34	7816.4534.0		23
7810.4561.5		23	7810.5286.0		31	7810.6612.5		34	7816.4535.0		23
7810.4562.0		23	7810.5286.5		31	7810.6805.0		35	7816.4536.0		23
7810.4562.5		23	7810.5287.0		31	7810.6809.0		35	7816.4537.0		23
7810.4563.0		23	7810.5287.5		31	7810.6814.0		30	7816.4538.0		23
7810.4563.5		23	7810.5304.0		31	7810.6819.0		30	7816.4543.0		23
7810.4564.0		23	7810.5304.5		31	7810.7003.0		34	7816.4544.0		23
7810.4564.5		23	7810.5305.0		31	7810.7003.5		34	7816.4555.0		23
7810.4565.0		23	7810.5305.5		31	7810.7004.0		34	7816.4556.0		23
7810.4571.0		23	7810.5306.0		31	7810.7004.5		34	7816.4557.0		23
7810.4572.0		23	7810.5306.5		31	7810.7007.0		28	7816.4558.0		23
7810.4573.0		23	7810.5307.0		31	7810.7008.0		29	7816.4566.0		23

Part No.	-	Page	Part No.	-	Page	Part No.	-	Page	Part No.	-	Page
7816.4566.5		23	7816.5291.0		31	7816.6507.0		28	7816.7565.0		32
7816.4567.0		23	7816.5291.5		31	7816.6508.0		28	7816.7575.0		32
7816.4567.5		23	7816.5292.0		31	7816.6521.0		33	7816.7576.0		32
7816.4568.0		23	7816.5292.5		31	7816.6522.0		33	7824.5009.0		35
7816.4568.5		23	7816.5293.0		31	7816.6533.0		29	7824.5010.0		35
7816.4569.0		23	7816.5293.5		31	7816.6537.0		35	7824.5011.0		35
7816.4569.5		23	7816.5309.0		31	7816.6545.0		33	7824.5012.0		35
7816.4570.0		23	7816.5309.5		31	7816.6546.0		33	7824.5031.0		35
7816.4575.0		23	7816.5310.0		31	7816.6547.0		28	7824.5032.0		35
7816.4576.0		23	7816.5310.5		31	7816.6548.0		28	7824.5033.0		35
7816.4577.0		23	7816.5311.0		31	7816.6549.0		28	7824.5034.0		35
7816.4586.0		24	7816.5311.5		31	7816.6550.0		28	7824.5052.0		36
7816.4586.5		24	7816.5312.0		31	7816.6557.0		28	7824.5056.0		36
7816.4587.0		24	7816.5312.5		31	7816.6558.0		28	7824.5066.0		36
7816.4587.5		24	7816.5313.0		31	7816.6571.0		33	7824.5067.0		36
7816.4588.0		24	7816.5313.5		31	7816.6572.0		33	7824.5068.0		36
7816.4588.5		24	7816.5365.0		34	7816.6583.0		29	7824.5069.0		36
7816.4589.0		24	7816.5366.0		34	7816.6587.0		35	7824.5078.0		37
7816.4589.5		24	7816.5367.0		34	7816.6615.0		34	7824.5078.5		37
7816.4592.0		23	7816.5368.0		34	7816.6615.5		34	7824.5079.0		37
7816.4595.0		23	7816.6305.0		26	7816.6616.0		34	7824.5079.5		37
7816.4994.0		23	7816.6306.0		26	7816.6616.5		34	7824.5080.0		37
7816.4995.0		23	7816.6315.0		26	7816.6618.0		34	7824.5080.5		37
7816.4996.0		23	7816.6316.0		26	7816.6618.5		34	7824.5081.0		37
7816.4997.0		23	7816.6324.0		32	7816.6619.0		34	7824.5081.5		37
7816.5005.0		35	7816.6325.0		32	7816.6619.5		34	7824.5096.0		37
7816.5006.0		35	7816.6355.0		26	7816.6621.0		34	7824.5097.0		37
7816.5007.0		35	7816.6356.0		26	7816.6621.5		34	7824.5098.0		37
7816.5008.0		35	7816.6365.0		26	7816.6622.0		34	7824.5099.0		37
7816.5027.0		35	7816.6366.0		26	7816.6622.5		34	7824.5108.0		37
7816.5028.0		35	7816.6374.0		32	7816.6806.0		35	7824.5108.5		37
7816.5029.0		35	7816.6375.0		32	7816.6810.0		35	7824.5109.0		37
7816.5030.0		35	7816.6405.0		28	7816.6815.0		30	7824.5109.5		37
7816.5051.0		36	7816.6406.0		28	7816.6820.0		30	7824.5110.0		37
7816.5055.0		36	7816.6413.0		32	7816.6921.0		33	7824.5110.5		37
7816.5063.0		36	7816.6423.0		33	7816.6922.0		33	7824.5111.0		37
7816.5064.0		36	7816.6423.5		33	7816.6923.0		35	7824.5111.5		37
7816.5065.0		36	7816.6424.0		33	7816.7019.0		28	7824.5122.0		37
7816.5074.0		37	7816.6424.5		33	7816.7021.0		33	7824.5126.0		37
7816.5074.5		37	7816.6431.0		28	7816.7022.0		33	7824.5147.0		36
7816.5075.0		37	7816.6431.5		28	7816.7113.0		33	7824.5148.0		36
7816.5075.5		37	7816.6432.0		28	7816.7168.0		26	7824.5149.0		36
7816.5076.0		37	7816.6432.5		28	7816.7169.0		26	7824.5150.0		36
7816.5076.5		37	7816.6435.0		34	7816.7170.0		26	7824.5151.0		36
7816.5077.0		37	7816.6435.5		34	7816.7171.0		26	7824.5152.0		36
7816.5077.5		37	7816.6436.0		34	7816.7172.0		26	7824.5153.0		36
7816.5093.0		37	7816.6436.5		34	7816.7173.0		26	7824.5154.0		36
7816.5094.0		37	7816.6439.0		29	7816.7174.0		26	7824.5178.0		36
7816.5095.0		37	7816.6439.5		29	7816.7175.0		26	7824.5179.0		36
7816.5104.0		37	7816.6440.0		29	7816.7176.0		26	7824.5180.0		36
7816.5104.5		37	7816.6440.5		29	7816.7207.0		28	7824.5181.0		36
7816.5105.0		37	7816.6445.0		33	7816.7215.0		27	7824.5182.0		36
7816.5105.5		37	7816.6445.5		33	7816.7216.0		27	7824.5183.0		36
7816.5106.0		37	7816.6446.0		33	7816.7238.0		27	7824.5184.0		36
7816.5106.5		37	7816.6446.5		33	7816.7239.0		27	7824.5185.0		36
7816.5107.0		37	7816.6453.0		28	7816.7240.0		27	7824.5244.0		31
7816.5107.5		37	7816.6453.5		28	7816.7241.0		27	7824.5246.0		31
7816.5121.0		37	7816.6454.0		28	7816.7242.0		27	7824.5248.0		31
7816.5125.0		37	7816.6454.5		28	7816.7243.0		27	7824.5250.0		31
7816.5138.0		36	7816.6457.0		34	7816.7244.0		27	7824.5273.0		31
7816.5139.0		36	7816.6457.5		34	7816.7245.0		27	7824.5295.0		31
7816.5140.0		36	7816.6458.0		34	7816.7246.0		27	7824.5295.5		31
7816.5141.0		36	7816.6458.5		34	7816.7255.0		27	7824.5296.0		31
7816.5142.0		36	7816.6461.0		29	7816.7256.0		27	7824.5296.5		31
7816.5143.0		36	7816.6461.5		29	7816.7282.0		26	7824.5297.0		31
7816.5144.0		36	7816.6462.0		29	7816.7283.0		26	7824.5297.5		31
7816.5145.0		36	7816.6462.5		29	7816.7284.0		26	7824.5298.0		31
7816.5169.0		36	7816.6473.0		33	7816.7285.0		26	7824.5298.5		31
7816.5170.0		36	7816.6473.5		33	7816.7286.0		26	7824.5314.0		31
7816.5171.0		36	7816.6474.0		33	7816.7287.0		26	7824.5314.5		31
7816.5172.0		36	7816.6474.5		33	7816.7288.0		26	7824.5315.0		31
7816.5173.0		36	7816.6481.0		29	7816.7289.0		26	7824.5315.5		31
7816.5174.0		36	7816.6481.5		29	7816.7290.0		26	7824.5316.0		31
7816.5175.0		36	7816.6482.0		29	7816.7468.0		32	7824.5316.5		31
7816.5176.0		36	7816.6482.5		29	7816.7469.0		32	7824.5317.0		31
7816.5232.0		31	7816.6487.0		33	7816.7470.0		32	7824.5317.5		31
7816.5234.0		31	7816.6487.5		33	7816.7471.0		32	7824.5318.0		31
7816.5236.0		31	7816.6488.0		33	7816.7472.0		32	7824.5318.5		31
7816.5238.0		31	7816.6488.5		33	7816.7473.0		32	7824.5370.0		34
7816.5240.0		31	7816.6495.0		29	7816.7474.0		32	7824.5371.0		34
7816.5272.0		31	7816.6495.5		29	7816.7475.0		32	7824.5372.0		34
7816.5290.0		31	7816.6496.0		29	7816.7476.0		32	7824.5373.0		34
7816.5290.5		31	7816.6496.5		29	7816.7564.0		32	7824.5374.0		34

Part No.	-	Page	Part No.	-	Page	Part No.	-	Page	Part No.	-	Page
7824.5375.0		34	7824.6626.5		34	7832.4617.0		24	7832.5086.0		37
7824.6307.0		26	7824.6627.0		34	7832.4618.0		24	7832.5086.5		37
7824.6308.0		26	7824.6627.5		34	7832.4619.0		24	7832.5112.0		37
7824.6317.0		26	7824.6628.0		34	7832.4631.0		24	7832.5112.5		37
7824.6318.0		26	7824.6628.5		34	7832.4633.0		24	7832.5113.0		37
7824.6326.0		32	7824.6630.0		34	7832.4641.0		24	7832.5113.5		37
7824.6327.0		32	7824.6630.5		34	7832.4641.5		24	7832.5114.0		37
7824.6357.0		26	7824.6632.0		34	7832.4642.0		24	7832.5114.5		37
7824.6358.0		26	7824.6632.5		34	7832.4642.5		24	7832.5115.0		37
7824.6367.0		26	7824.6807.0		35	7832.4643.0		24	7832.5115.5		37
7824.6368.0		26	7824.6811.0		35	7832.4643.5		24	7832.5116.0		37
7824.6376.0		32	7824.6816.0		30	7832.4644.0		24	7832.5116.5		37
7824.6377.0		32	7824.6821.0		30	7832.4644.5		24	7832.5123.0		37
7824.6407.0		28	7824.6924.0		28	7832.4647.0		25	7832.5127.0		37
7824.6408.0		28	7824.6925.0		28	7832.4648.0		25	7832.6309.0		26
7824.6414.0		32	7824.6926.0		33	7832.4649.0		25	7832.6310.0		26
7824.6425.0		33	7824.6927.0		33	7832.4651.0		25	7832.6319.0		26
7824.6425.5		33	7824.7032.0		33	7832.4651.5		25	7832.6320.0		26
7824.6426.0		33	7824.7033.0		33	7832.4652.0		25	7832.6328.0		32
7824.6426.5		33	7824.7034.0		33	7832.4652.5		25	7832.6329.0		32
7824.6433.0		28	7824.7043.0		28	7832.4653.0		25	7832.6330.0		26
7824.6433.5		28	7824.7120.0		33	7832.4653.5		25	7832.6331.0		26
7824.6434.0		28	7824.7121.0		33	7832.4654.0		25	7832.6332.0		26
7824.6434.5		28	7824.7146.0		35	7832.4654.5		25	7832.6333.0		26
7824.6437.0		34	7824.7147.0		29	7832.4656.0		25	7832.6334.0		26
7824.6437.5		34	7824.7178.0		26	7832.4656.5		25	7832.6335.0		26
7824.6438.0		34	7824.7179.0		26	7832.4657.0		25	7832.6336.0		26
7824.6438.5		34	7824.7180.0		26	7832.4657.5		25	7832.6337.0		26
7824.6441.0		29	7824.7181.0		26	7832.4658.0		25	7832.6338.0		32
7824.6441.5		29	7824.7182.0		26	7832.4658.5		25	7832.6339.0		32
7824.6442.0		29	7824.7183.0		26	7832.4659.0		25	7832.6340.0		32
7824.6442.5		29	7824.7184.0		26	7832.4659.5		25	7832.6341.0		32
7824.6447.0		33	7824.7185.0		26	7832.4661.0		25	7832.6359.0		26
7824.6447.5		33	7824.7201.0		27	7832.4662.0		25	7832.6360.0		26
7824.6448.0		33	7824.7202.0		27	7832.4663.0		25	7832.6369.0		26
7824.6448.5		33	7824.7203.0		27	7832.4665.0		25	7832.6370.0		26
7824.6455.0		28	7824.7204.0		27	7832.4665.5		25	7832.6378.0		32
7824.6455.5		28	7824.7208.0		28	7832.4666.0		25	7832.6379.0		32
7824.6456.0		28	7824.7217.0		27	7832.4666.5		25	7832.6380.0		26
7824.6456.5		28	7824.7218.0		27	7832.4667.0		25	7832.6381.0		26
7824.6459.0		34	7824.7247.0		27	7832.4667.5		25	7832.6382.0		26
7824.6459.5		34	7824.7248.0		27	7832.4668.0		25	7832.6383.0		26
7824.6460.0		34	7824.7249.0		27	7832.4668.5		25	7832.6384.0		32
7824.6460.5		34	7824.7250.0		27	7832.4671.0		25	7832.6385.0		32
7824.6463.0		29	7824.7257.0		27	7832.4672.0		25	7832.6409.0		28
7824.6463.5		29	7824.7258.0		27	7832.4673.0		25	7832.6410.0		28
7824.6464.0		29	7824.7292.0		26	7832.4674.0		25	7832.6415.0		32
7824.6464.5		29	7824.7293.0		26	7832.4700.0		24-38	7832.6511.0		29
7824.6475.0		33	7824.7294.0		26	7832.4700.1		38	7832.6511.5		29
7824.6475.5		33	7824.7295.0		26	7832.4700.4		38	7832.6512.0		28
7824.6476.0		33	7824.7296.0		26	7832.4705.0		24-38	7832.6512.5		28
7824.6476.5		33	7824.7297.0		26	7832.4705.1		38	7832.6525.0		33
7824.6483.0		29	7824.7298.0		26	7832.4705.4		38	7832.6525.5		33
7824.6483.5		29	7824.7299.0		26	7832.4710.0		24-38	7832.6526.0		33
7824.6484.0		29	7824.7478.0		32	7832.4715.0		24-38	7832.6526.5		33
7824.6484.5		29	7824.7479.0		32	7832.5013.0		35	7832.6527.0		33
7824.6489.0		33	7824.7480.0		32	7832.5014.0		35	7832.6527.5		33
7824.6489.5		33	7824.7481.0		32	7832.5015.0		35	7832.6528.0		33
7824.6490.0		33	7824.7482.0		32	7832.5016.0		35	7832.6528.5		33
7824.6490.5		33	7824.7483.0		32	7832.5017.0		35	7832.6529.0		33
7824.6497.0		29	7824.7484.0		32	7832.5018.0		35	7832.6529.5		33
7824.6497.5		29	7824.7485.0		32	7832.5019.0		35	7832.6530.0		33
7824.6498.0		29	7824.7566.0		32	7832.5020.0		35	7832.6530.5		33
7824.6498.5		29	7824.7567.0		32	7832.5021.0		35	7832.6535.0		29
7824.6509.0		28	7824.7577.0		32	7832.5022.0		35	7832.6535.5		29
7824.6510.0		28	7824.7578.0		32	7832.5035.0		35	7832.6539.0		34
7824.6523.0		33	7832.4600.0		24	7832.5036.0		35	7832.6539.5		34
7824.6524.0		33	7832.4601.0		24	7832.5037.0		35	7832.6540.0		34
7824.6534.0		29	7832.4602.0		24	7832.5038.0		35	7832.6540.5		34
7824.6538.0		35	7832.4603.0		24	7832.5039.0		35	7832.6541.0		34
7824.6543.0		33	7832.4604.0		24	7832.5040.0		35	7832.6541.5		34
7824.6544.0		33	7832.4605.0		24	7832.5041.0		35	7832.6561.0		29
7824.6559.0		28	7832.4606.0		24	7832.5042.0		35	7832.6561.5		29
7824.6560.0		28	7832.4607.0		24	7832.5043.0		35	7832.6562.0		28
7824.6573.0		33	7832.4608.0		24	7832.5044.0		35	7832.6562.5		28
7824.6574.0		33	7832.4609.0		24	7832.5053.0		36	7832.6575.0		33
7824.6584.0		29	7832.4610.0		24	7832.5057.0		36	7832.6575.5		33
7824.6588.0		35	7832.4611.0		24	7832.5082.0		37	7832.6576.0		33
7824.6613.0		28	7832.4612.0		24	7832.5082.5		37	7832.6576.5		33
7824.6614.0		28	7832.4613.0		24	7832.5083.0		37	7832.6577.0		33
7824.6625.0		34	7832.4614.0		24	7832.5083.5		37	7832.6577.5		33
7824.6625.5		34	7832.4615.0		24	7832.5085.0		37	7832.6578.0		33
7824.6626.0		34	7832.4616.0		24	7832.5085.5		37	7832.6578.5		33

Part No.	-	Page	Part No.	-	Page	Part No.	-	Page	Part No.	-	Page
7832.6579.0		33	7932.3008.0		40	8000.6281.4		57	8100.8215.4		66
7832.6579.5		33	7932.3013.0		40	8000.6282.0		57	8100.8216.0		67
7832.6580.0		33	7932.3020.0		40	8000.6282.4		57	8100.8216.4		67
7832.6580.5		33	7932.3021.0		40	8000.6283.0		57	8100.8218.0		67
7832.6585.0		29	7932.3022.0		40	8000.6283.4		57	8100.8218.4		67
7832.6585.5		29	7932.3023.0		40	8000.6284.0		57	8100.8219.0		68
7832.6589.0		34	7932.3024.0		40	8000.6284.4		57	8100.8219.4		68
7832.6589.5		34	7932.3025.0		40	8000.6285.0		57	8100.8221.0		68
7832.6590.0		34	7932.3027.0		40	8000.6285.4		57	8100.8221.4		68
7832.6590.5		34	7932.3029.0		40	8000.6286.0		57	8100.8222.0		69
7832.6591.0		34	7932.3031.0		40	8000.6286.4		57	8100.8222.4		69
7832.6591.5		34	7932.3033.0		40	8000.6287.0		57	8100.8223.0		69
7832.6808.0		35	7932.3035.0		40	8000.6287.4		57	8100.8223.4		69
7832.6812.0		35	7932.4001.0		40	8000.6288.0		57	8100.8224.0		70
7832.6817.0		30	7932.4002.0		40	8000.6288.4		57	8100.8224.4		70
7832.6822.0		30	7932.4003.0		40	8000.6291.0		57-58	8100.8225.0		70
7832.7048.0		33	7932.4004.0		40	8000.6292.0		57-58	8100.8225.4		70
7832.7134.0		28	7932.4005.0		40	8000.6293.0		57-58	8100.8227.0		71
7832.7134.5		28	7932.4006.0		40	8000.6294.0		57-58	8100.8227.4		71
7832.7135.0		28	7932.4007.0		40	8000.6295.0		57-58	8100.8240.0		71
7832.7135.5		28	7932.4008.0		40	8000.6296.0		57-58	8100.8240.4		71
7832.7136.0		29	7932.4013.0		40	8000.6297.0		57-58	8100.8305.1		62
7832.7136.5		29	7932.4020.0		40	8000.6298.0		57-58	8100.8306.1		62
7832.7137.0		29	7932.4021.0		40	8000.6300.0		59	8100.8307.1		63
7832.7137.5		29	7932.4022.0		40	8100.8005.0		62	8100.8308.1		63
7832.7139.0		29	7932.4023.0		40	8100.8006.0		62	8100.8309.1		64
7832.7139.5		29	7932.4024.0		40	8100.8007.0		63	8100.8310.1		64
7832.7142.0		33	7932.4025.0		40	8100.8008.0		63	8100.8311.1		65
7832.7142.5		33	7932.4027.0		40	8100.8009.0		64	8100.8313.1		65
7832.7148.0		28	7932.4029.0		40	8100.8010.0		64	8100.8314.1		66
7832.7568.0		32	7932.4031.0		40	8100.8011.0		65	8100.8315.1		66
7832.7569.0		32	7932.4033.0		40	8100.8013.0		65	8100.8316.1		67
7832.7570.0		32	7932.4035.0		40	8100.8014.0		66	8100.8318.1		67
7848.6321.0		26	8000.6252.0		59	8100.8015.0		66	8100.8319.1		68
7848.6342.0		26	8000.6253.0		59	8100.8016.0		67	8100.8321.1		68
7848.6371.0		26	8000.6253.3		59	8100.8018.0		67	8100.8322.1		69
7848.6386.0		26	8000.6254.0		59	8100.8019.0		68	8100.8323.1		69
7848.6411.0		28	8000.6254.3		59	8100.8021.0		68	8100.8324.1		70
7848.6513.0		29	8000.6255.0		59	8100.8022.0		69	8100.8325.1		70
7848.6513.5		29	8000.6255.3		59	8100.8023.0		69	8100.8327.1		71
7848.6514.0		29	8000.6256.0		59	8100.8024.0		70	8100.8340.1		71
7848.6514.5		29	8000.6256.3		59	8100.8025.0		70	8500.6251.0		52
7848.6515.0		29	8000.6257.0		59	8100.8027.0		71	8500.7909.0		52
7848.6515.5		29	8000.6257.3		59	8100.8040.0		71	8500.7910.0		52
7848.6516.0		28	8000.6261.0		57	8100.8105.0		62	8500.7911.0		52
7848.6516.5		28	8000.6261.1		57	8100.8106.0		62	8500.7912.0		52-48
7848.6517.0		28	8000.6261.2		57	8100.8107.0		63	8500.7922.0		52
7848.6517.5		28	8000.6261.3		57	8100.8108.0		63	8500.7925.0		52
7848.6518.0		28	8000.6262.0		57	8100.8109.0		64	8500.7926.0		52
7848.6518.5		28	8000.6262.1		57	8100.8110.0		64	8500.7927.0		52
7848.6563.0		29	8000.6262.2		57	8100.8111.0		65	8500.7930.0		52
7848.6563.5		29	8000.6262.3		57	8100.8113.0		65	8500.7931.0		52
7848.6564.0		29	8000.6263.0		57	8100.8114.0		66	8500.7932.0		52
7848.6564.5		29	8000.6263.1		57	8100.8115.0		66	8500.7940.0		52
7848.6565.0		29	8000.6263.2		57	8100.8116.0		67	8500.7945.0		52
7848.6565.5		29	8000.6263.3		57	8100.8118.0		67	8500.7948.0		52
7848.6566.0		28	8000.6264.0		57	8100.8119.0		68	8500.7956.0		53
7848.6566.5		28	8000.6264.1		57	8100.8121.0		68	8500.7957.0		53
7848.6567.0		28	8000.6264.2		57	8100.8122.0		69	8500.7958.0		53
7848.6567.5		28	8000.6264.3		57	8100.8123.0		69	8500.7970.0		53
7848.6568.0		28	8000.6265.0		57	8100.8124.0		70	8500.7971.0		53
7848.6568.5		28	8000.6265.1		57	8100.8125.0		70	8500.7972.0		53
7848.7149.0		28	8000.6265.2		57	8100.8127.0		71	8500.7973.0		53
7848.7429.0		26	8000.6265.3		57	8100.8140.0		71	8500.7974.0		53
7848.7430.0		26	8000.6266.0		57	8100.8205.0		62	8500.7980.0		53
7848.7431.0		26	8000.6266.1		57	8100.8205.4		62	8500.7982.0		53
7848.7433.0		26	8000.6266.2		57	8100.8206.0		62	8500.7984.0		53
7848.7440.0		28	8000.6266.3		57	8100.8206.4		62	8500.7986.0		53
7848.7530.0		26	8000.6267.0		57	8100.8207.0		63			
7848.7531.0		26	8000.6267.1		57	8100.8207.4		63			
7908.6640.1		22	8000.6267.2		57	8100.8208.0		63			
7908.6643.1		22	8000.6267.3		57	8100.8208.4		63			
7908.6646.1		22	8000.6268.0		57	8100.8209.0		64			
7908.6648.1		22	8000.6268.1		57	8100.8209.4		64			
7908.6667.1		22	8000.6268.2		57	8100.8210.0		64			
7908.6668.1		22	8000.6268.3		57	8100.8210.4		64			
7932.3001.0		40	8000.6272.0		59	8100.8211.0		65			
7932.3002.0		40	8000.6273.0		59	8100.8211.4		65			
7932.3003.0		40	8000.6274.0		59	8100.8213.0		65			
7932.3004.0		40	8000.6275.0		59	8100.8213.4		65			
7932.3005.0		40	8000.6276.0		59	8100.8214.0		66			
7932.3006.0		40	8000.6277.0		59	8100.8214.4		66			
7932.3007.0		40	8000.6281.0		57	8100.8215.0		66			



Westec products are available worldwide through a network of local distributors.
Please contact us at info@westec.it to locate your nearest one.

Westec®

GWconnect®

Westec S.r.l. Via Fiume Lambro 1, 20097 San Donato Milanese (MI) - Italy
Tel. +39 02 512317 - Fax +39 02 55700 318 / 226 - E-mail: info@westec.it
www.westec.it